

SL POWER CINT1275 SERIES

275 Watts Single Output
Industrial Grade

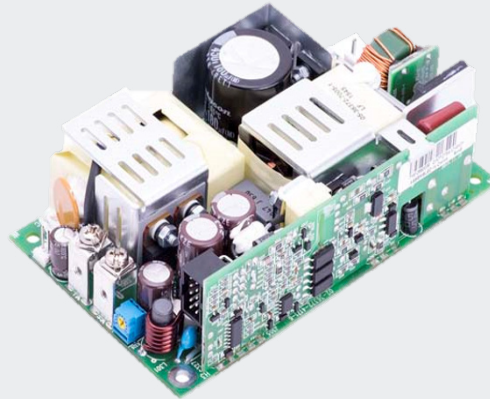

Industrial

Advanced Energy's SL Power CINT1275 family offering in high density single output open-frame AC/DC power supplies. Approved to EN/CSA/IEC/UL62368-1. The CINT1275 operates at universal input range of 90 to 264 VAC and wide temperature range -10°C to +70°C, delivering full rated output power up to +50°C. In addition, these models feature Power Fail, DC OK, Inhibit signals.

AT A GLANCE

Total Power

275 Watts

Input Voltage

90 to 264 VAC

of Outputs

Single

SPECIAL FEATURES

- 3"W x 5"L x 1.4"H Size
- For 1U Applications
- Universal Input 90 to 264 VAC
- 275 W w/air, 180 W Convection Cooled
- 12 V Fan and 5 V Standby Output
- Forced Current Share
- 92% Efficiency Typical
- Power Fail/DC OK/Inhibit Signal
- Approved to EN/CSA/IEC/UL62368-1
- ROHS Compliant
- 3 Years Warranty

SAFETY

- EN/CSA/IEC/UL62368-1



ELECTRICAL SPECIFICATIONS

Input	
Input Range	90 to 264 VAC, 47 to 63 Hz, 1Ø 127 to 370 VDC
Turn-On Input Voltage	80 VAC, nominal
Turn-Off Input Voltage	75 VAC, nominal
Power Factor	> 0.9
Switching Frequency	PFC: variable, 30 to 400 kHz typical Main converter: variable 30 to 250 kHz, 65 to 70 kHz at full load
Inrush Current	50 A max., cold start @ 264 VAC input
Input Current	90VAC: 3.7 A max, 115 VAC: 3 A, 230 VAC: 1.5 A
Input Fuses	5A, 275 VAC fuses provided on all models
Earth Leakage Current	<750 µA @ 264 VAC, 60 Hz, NC
Efficiency	92% typical
Isolation Voltage	Input/Ground: 1800 VAC Input/Output: 4000 VAC Output/Ground: 1500 VAC
Output	
Maximum Power	275 W continuous with 200 LFM airflow, 180 W convection cooled, see chart for specific voltage model ratings
Ripple and Noise	0.5% rms, 1% pk-pk, see chart
Total Regulation	+/-3% combined line, load and initial setting
Static Line Current V1	+/-1% Vo nominal
Static Load Current V1	+/-3% Vo nominal
Minimum Load	Not required
Output Voltage	See chart
Adjustment Range	+/-5% from nominal, except 56 V
Transient Response	50% load step, $\Delta i/\Delta t < 0.2 \text{ A}/\mu\text{s}$. Max. voltage deviation is 3%. 500 us typical, return to 0.5% of nominal.
Auxiliary Signals	
AC Power Fail	During normal operations, stays HIGH. Signal goes LOW with 5 ms warning before loss of DC output from AC failure
Inhibit	Connect to inhibit pin (J201 pin 5) to output common to inhibit the DC output
DC OK	Open collector logic signal goes and stays HIGH 100 ms to 500 ms after main output reaches regulation
Standby Output	5 V, 200 mA
Remote Sense	Compensates for up to 250 mV drop in load lines
Fan Output	12 V, 1 A
Current Share	Forced current sharing provided for up to 5 units connected in parallel
Reliability	
MTBF	4,65,000 hrs at 275 W load, 110 VAC input, 25°C ambient
Warranty	3 years
Protection	
Overvoltage Protection	OVP latch at 110 to 130% of output voltage
Short Circuit Protection	Hiccup mode, auto recovery
Thermal Protection	Sensing transformer temperature, 135°C (55°C ambient temperature at full load), latching type
Overload Protection	120 to 150% of rating, hiccup mode

EMI/EMC COMPLIANCE

Conducted Emissions	EN55011/22: Class B, FCC Part 15, Subpart B, Class B
Radiated Emissions	EN55011/22: Class A, FCC Part 15, Subpart B, Class A w/6db Margin
Line Harmonic Emissions	EN61000-3-2, Class A, B, C, D
Voltage Fluctuations & Flicker	EN61000-3-3, Complies (dmax < 6%)
Static Discharge Immunity	EN61000-4-2, 6kV Contact, 8kV Air
Radiated RF EM Immunity	EN61000-4-3, 3 V/m
Electrical Fast Transients / Bursts	EN61000-4-4, 2 kV/5 KHz
Surges Line to Line (DM) and Line to Ground (CM)	EN61000-4-5, 1kV DM, 2kV CM
Conducted Disturbances Induced by RF Fields	EN61000-4-6, 3 Vrms
Power Frequency Magnetic Fields Immunity	EN61000-4-8, 3 A/m
Voltage Dips	EN61000-4-11, 100%, 10 ms; 30%, 275 ms; 60%, 100 ms; Performance Criteria A, at 70% Load.

ENVIRONMENTAL SPECIFICATIONS

Vibration	Operating: 0.003 g/Hz, 1.5 grams overall, 3 axes, 10 min/axis Non-operating: 0.026 g ² /Hz, 5 grams overall, 3 axes, 1 hr/axis
Shock	Operating: Half-sine, 20 gpk, 10 ms, 3 axes, 6 shocks total. Non-operating: Half-sine, 40 gpk, 10 ms, 3 axes, 6 shocks total
Operating Temperature	-10°C to +70°C, -40°C start up, full load
Temperature Derating	Derate output power above 50°C to 50% at 70°C
Storage Temperature	-40°C to +85°C
Altitude	Operating: -500 to 10,000 ft. Non-operating: -500 to 40,000 ft
Relative Humidity	5% to 95%, non-condensing
Weight	325 g

ORDERING INFORMATION

Model Number	Output Voltage	Output Current		Fan Output	Ripple & Noise ²	Total Regulation	OVP Threshold ³
		w/200 LFM air	Convection ¹				
CINT1275A1214K01	12 V	21.8 A	15.0 A	12.0 V / 1 A	120 mV pk-pk	+/-3%	14.0 ± 1.1 V
CINT1275A1514K01	15 V	18.3 A	12.0 A	12.0 V / 1 A	150 mV pk-pk	+/-3%	19.5 ± 1.5 V
CINT1275A2414K01	24 V	10.9 A	7.50 A	12.0 V / 1 A	240 mV pk-pk	+/-3%	28.0 ± 2.5 V
CINT1275A4814K01	48 V	5.46 A	3.75 A	12.0 V / 1 A	480 mV pk-pk	+/-3%	55.0 ± 4.0 V
CINT1275A5614K01	56 V	4.68 A	3.21 A	12.0 V / 1 A	560 mV pk-pk	+/-3%	59.0 ± 1.0 V

Notes:

1. Total convection output power is 180 W.

2. Measured with noise probe directly across output terminals, and load terminated with 0.1 µF ceramic and 10 µF low ESR capacitors.

3. No output adjustment on 56 V.

SYSTEM TIMING SPECIFICATIONS

Parameter	Min	Typ	Max	Unit
Turn On Time - 115 VAC inversely proportional to input voltage and thermistor temperature	-	-	2000	ms
Hold Up Time - 120 VAC @ 100% load	-	16	-	ms
Start Up Time - V_i nom, I_o nom	0	-	2	s

PIN ASSIGNMENTS

Type	Connector	Pin #	Assignment	Mating Connector
INPUT	-	1	AC Line	Molex: 09-50-3031 Pins: 08-52-0072
		2	Empty	
		3	AC Neutral	
GROUND	-	0.25" FASTON TAB	-	Molex: 01-90020001
MAIN OUTPUT	J302	1	+Vout	Molex: 19141-0058 / 19141-0063 / 19141-0083
		2	+Vout	
		3	+Vout	
	J303	4	-Vout	
		5	-Vout	
		6	-Vout	
FAN OUTPUT ¹	J301	1	+12 V FAN TRN	Molex: 22-01-3027 Pins: 08-50-0114
		2	+12 V	
SIGNAL CONNECTOR	J201	1	Remote Sense (+)	Molex: 1375820-2 Pins: 1375819
		2	Common	
		3	Remote Sense (-)	
		4	Current Share	
		5	Inhibit	Molex: 90142-0010 Pins: 90119-219 or 2120
		6	Common	
		7	Power Good	
		8	+5Vsb	
		9	DC OK	
		10	+5Vsb TRN	

Notes:

1. J301 provides a 12 V @ 1 A output to support a system cooling fan.

MECHANICAL DRAWING

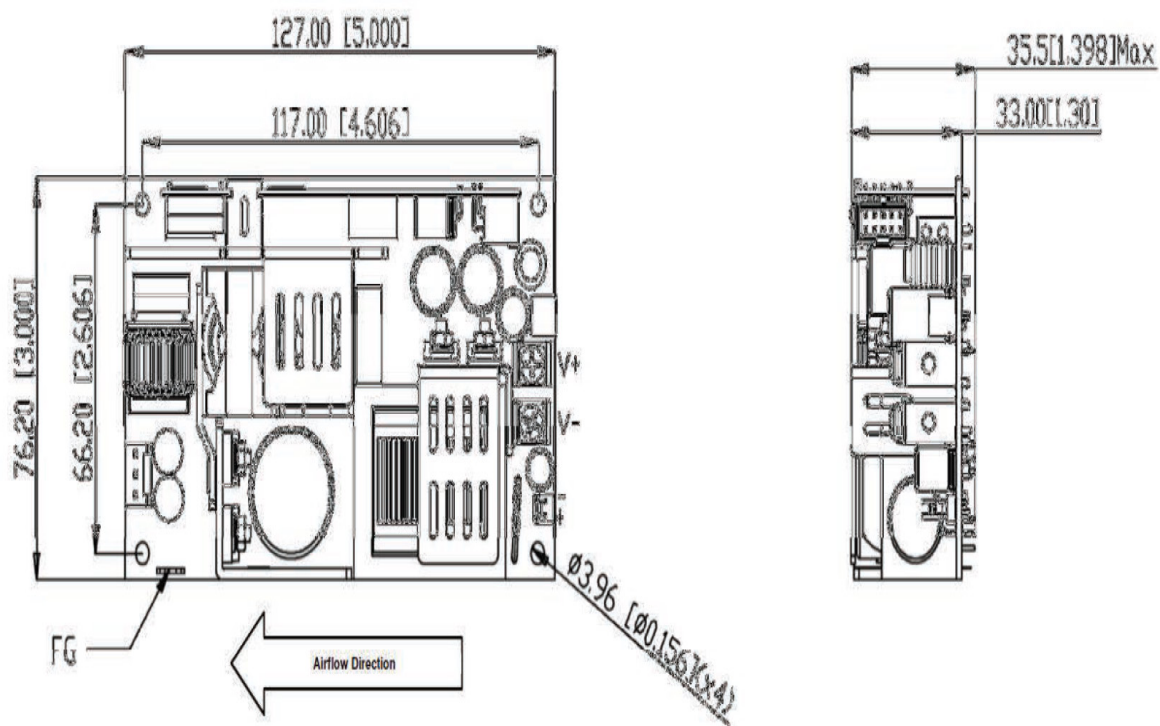

Notes:

1. All dimensions in mm (inches).
2. Mounting holes should be grounded for EMI purposes.
3. FG is safety ground connection.
4. The power supply requires mounting on metal standoffs 0.2" (5 mm) in height, min.

AC POWER FAIL/DC OK AND INHIBIT SIGNALS - J101

Power Fail / DC OK

PF / DC OK: During normal operation stays HIGH.

Goes HIGH 100 to 500 ms after main output.

Goes LOW with 5 ms warning before loss of output from AC failure.

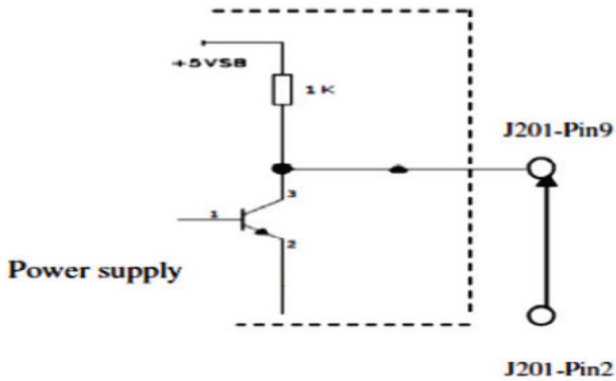

AC Power failure and DC OK signals use the same pin, so the signals can be used as follows

DC OK: when J201 Pin9 is HIGH

AC Power Fail: when J201 Pin9 is LOW

Inhibit

Disable: J201 pin 5 is LOW or GND

Enable: J201 pin 5 is OPEN

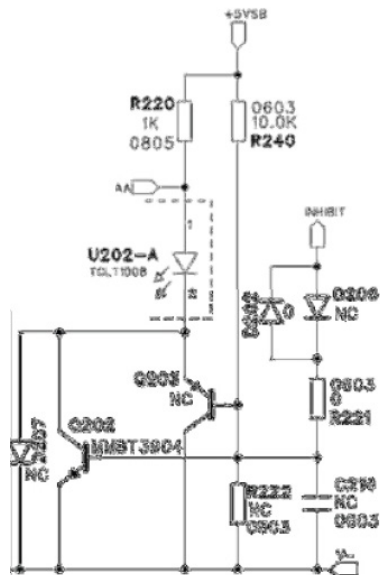

CURRENT SHARING / REMOTE SENSE

Timing Sequence

The outputs of N+1 (N=1,2,...5) models can be shared. It is shown in below, one load-share controller is required for each model and circuits are identical when N+ 1 identical models are used.

Terminals J302 and J303 are connected to the Vo+ and Vo-, respectively, of the first power model. The Vo+ and Vo- correspond to the other models positive and negative output pins. The Vo+ connects to positive output bus to the load and Vo- connects the negative output bus to the load.

The J201 pin1 and pin3 connects to the S+ and S-, respectively, of the first power models. The S+ and S- correspond to the other models J201 pin1 and pin3. The S+ connects to positive output bus and S- connects to negative output bus.

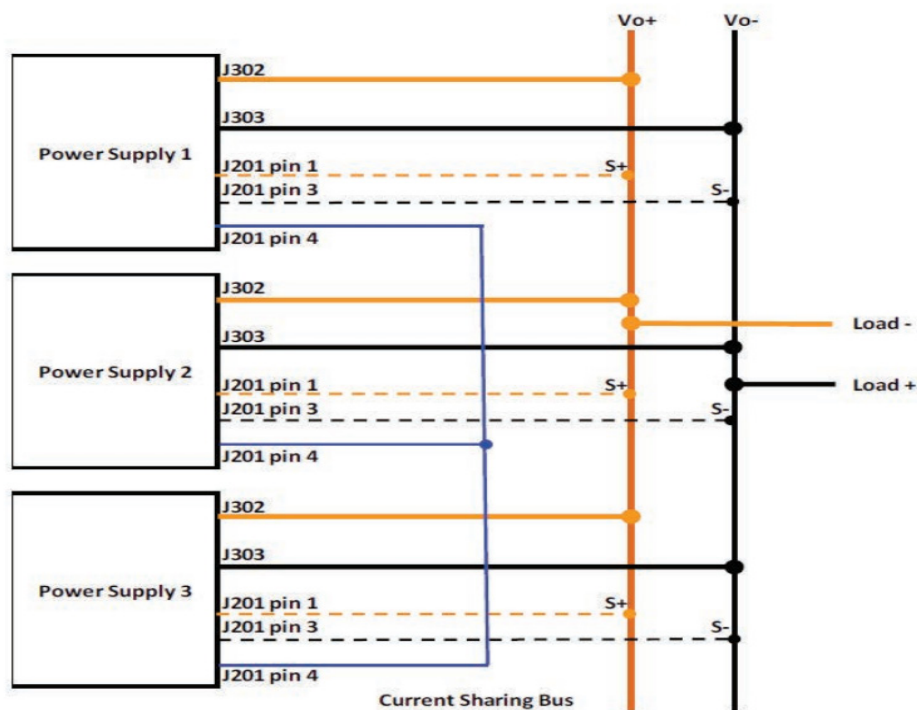

Remote Sense < 250 mV drop compensation:

The J201 Pin4 connects to current sharing bus that it connects to other models J201 pin4.

Timing

Timing Sequence

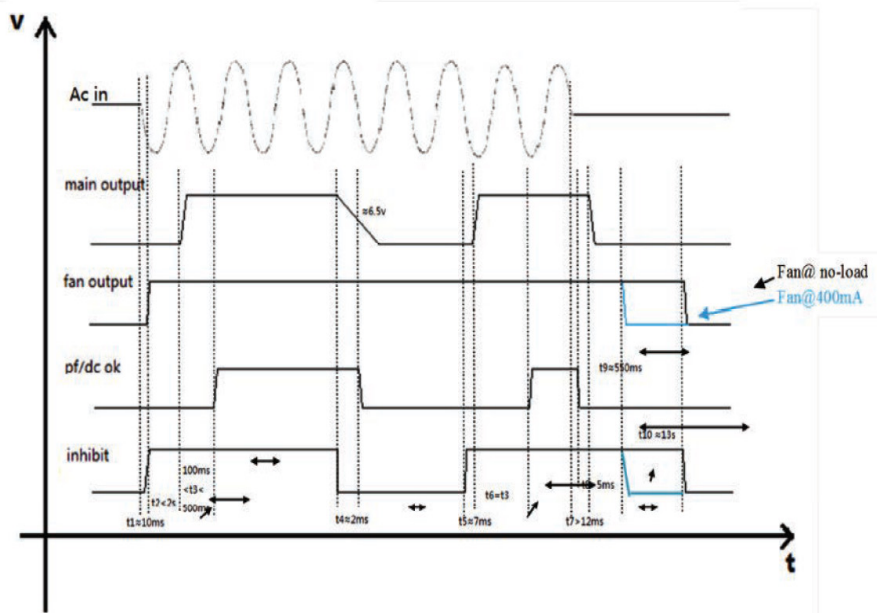

CHARACTERISTIC CURVES

Output vs Temperature

180 W convection cooled and 275 W continuous with 200 LFM airflow, derating output power to 50% at 70°C

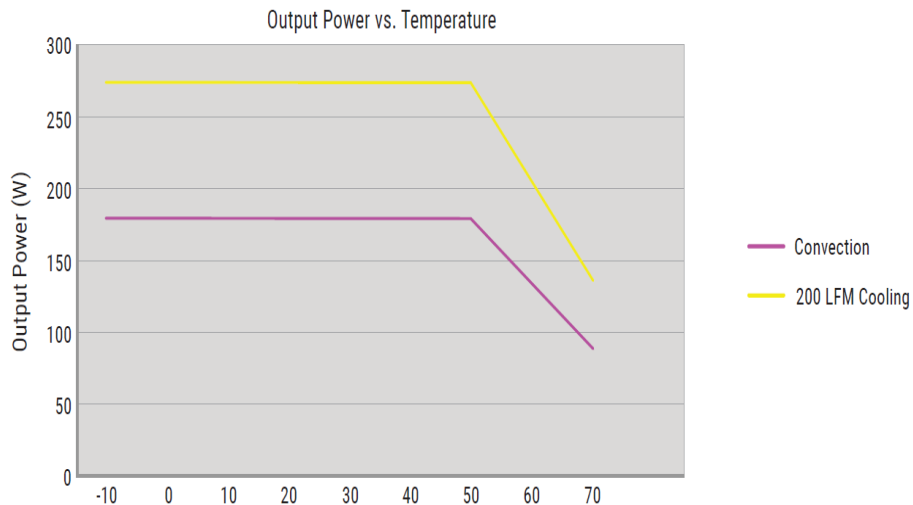

Efficiency vs. Loading

The high efficiency is achieved by using LLC technology with CCM mode PFC topology, and synchronous rectifiers on the output in all of this family models, minimizing switching losses

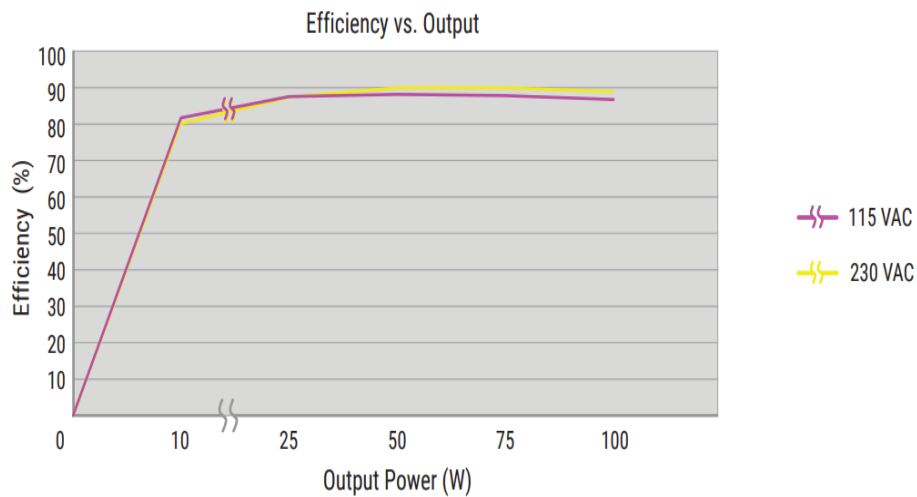

CHARACTERISTIC CURVES

Ripple & Noise

To verify that the output ripple and noise does not exceed the level specified in the product specification. Measured using a scope probe socket with 0.1 μ F ceramic and a 10 μ F electrolysis capacitor connected in parallel across it, BW limit with 20 MHz.

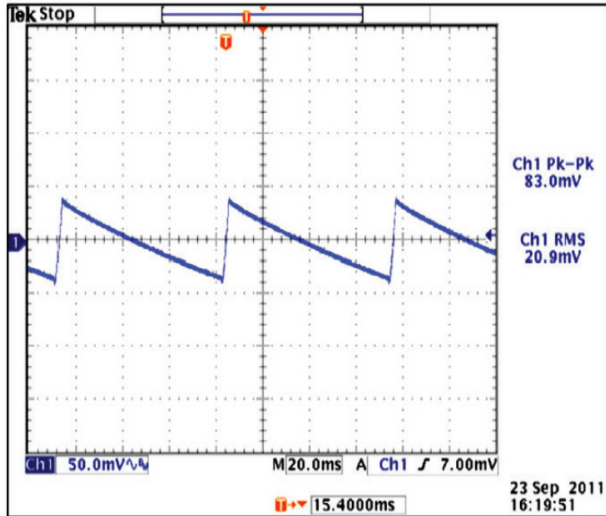

12V OUT, NO LOAD, 115VAC, 60HZ

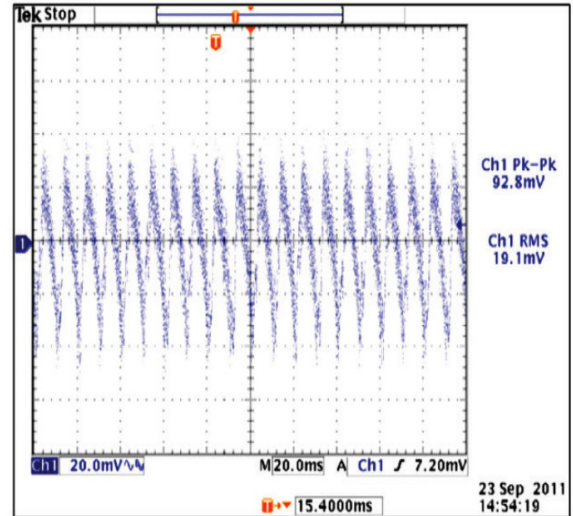

12V OUT, FULL LOAD, 115VAC, 60HZ

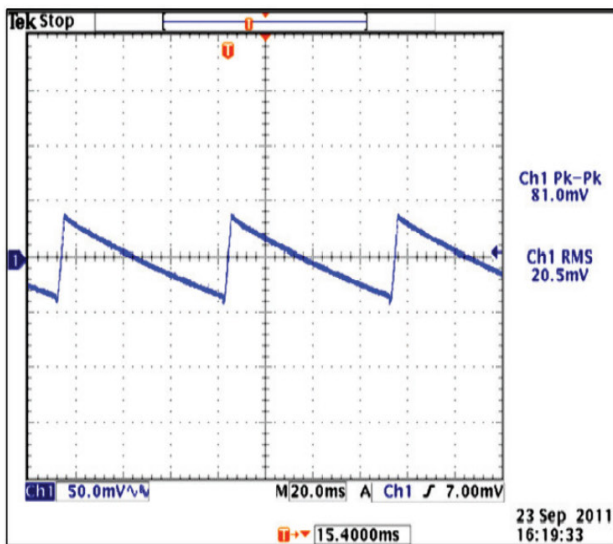

12V OUT, NO LOAD, 230VAC, 60HZ

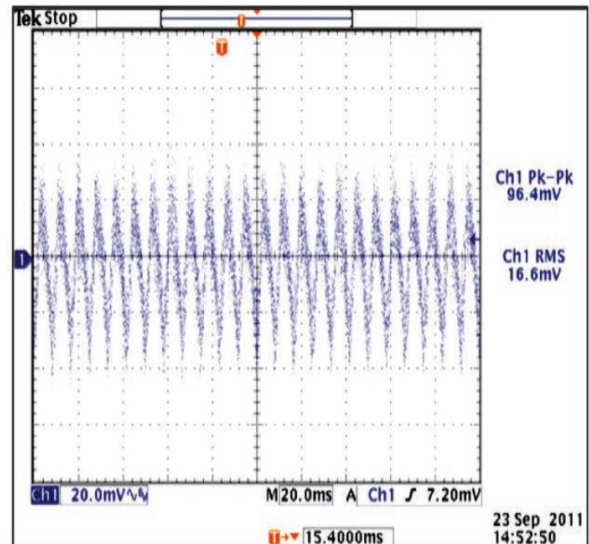

12V OUT, FULL LOAD, 230VAC, 60HZ

CHARACTERISTIC CURVES

Output Overload Characteristic

Supply shall protect itself against overload conditions. The power supply shall recover from overload conditions without operator intervention.

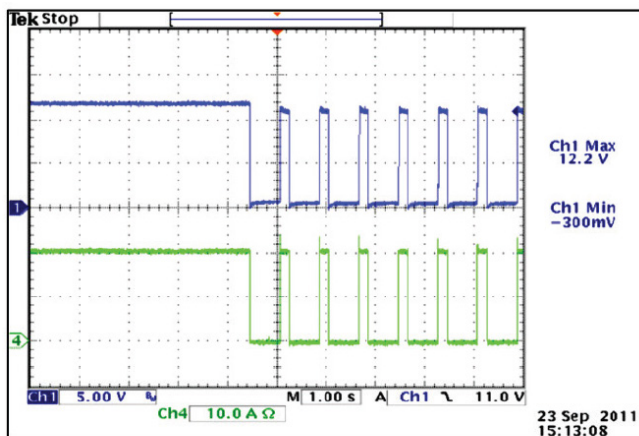

12V OUT, 90VAC

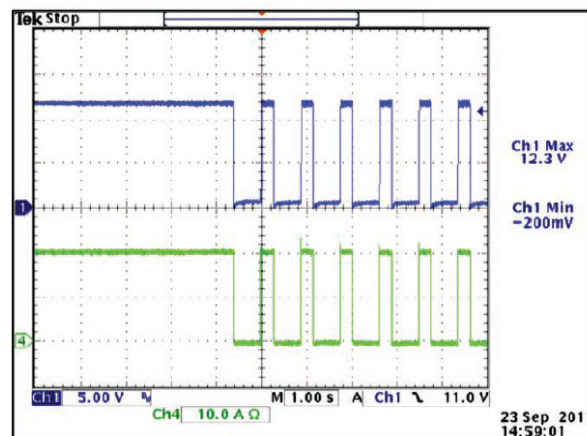

12V OUT, 264VAC

Output Transient Response

50% load step within the regulation limits of minimum and maximum load, $di/dt < 0.2 \text{ A}/\mu\text{s}$. Recovery time not specified as there is no laps in regulation with a 50% Load Step. Maximum voltage deviation is 3%. This test is performed on the MAIN OUTPUT ONLY.

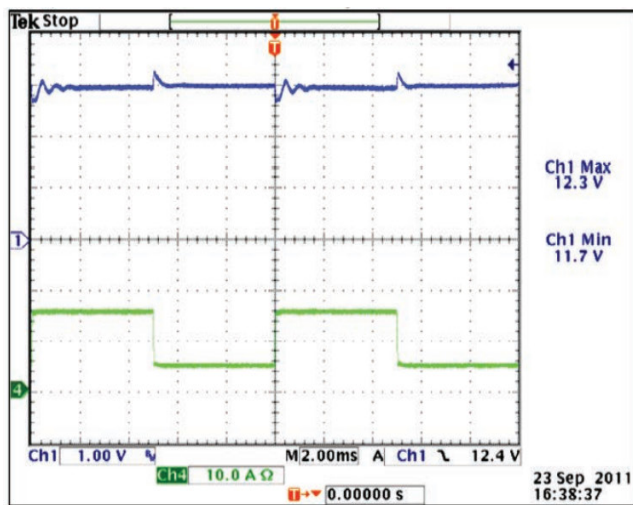

12V OUT, 115VAC, 25% TO 75% LOAD STEP

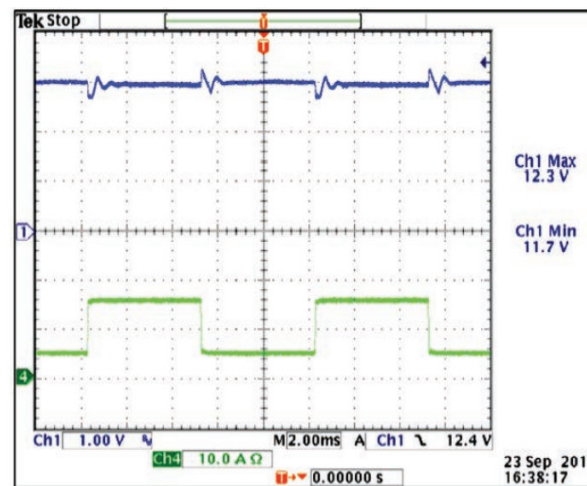

12V OUT, 230VAC, 25% TO 75% LOAD STEP

CHARACTERISTIC CURVES

Turn-on Time

When supply is turned on/off or when the load is stepped 100%, the Power Supply Overshoot/Undershoot shall not exceed minimum or maximum of output voltage regulation.

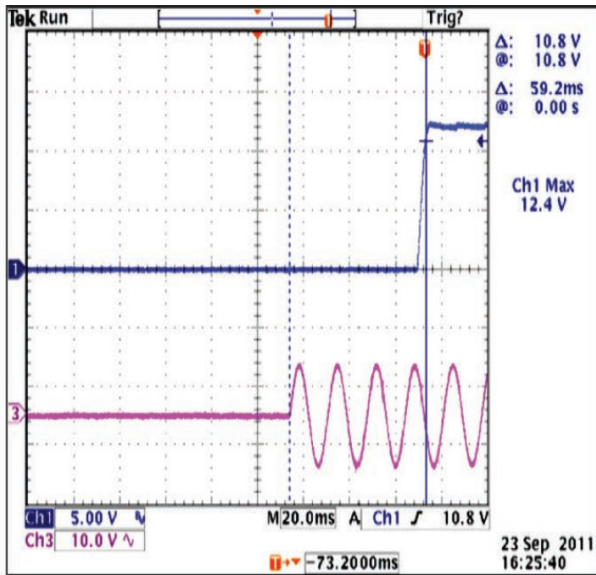

12V OUT, NO LOAD, 90VAC

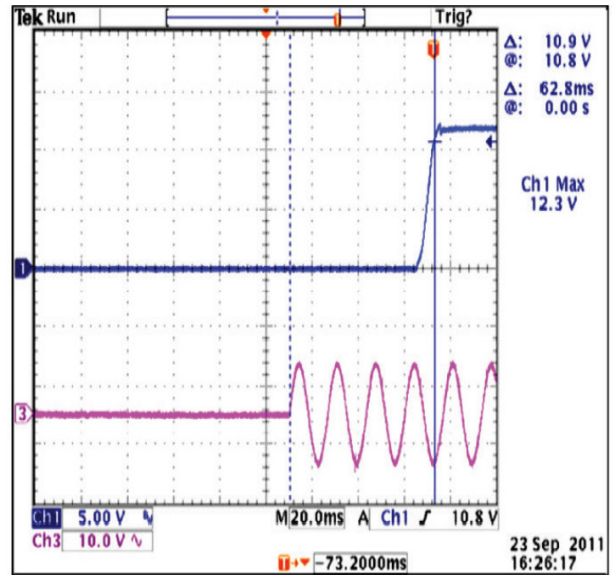

12V OUT, FULL LOAD, 90VAC

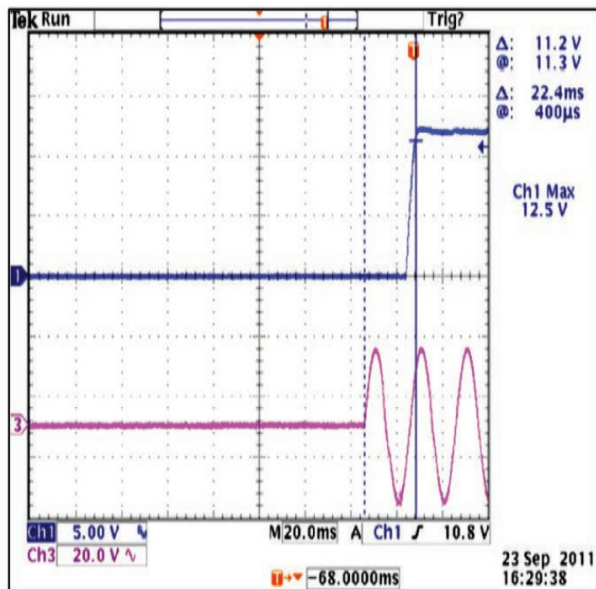

12V OUT, NO LOAD, 264VAC

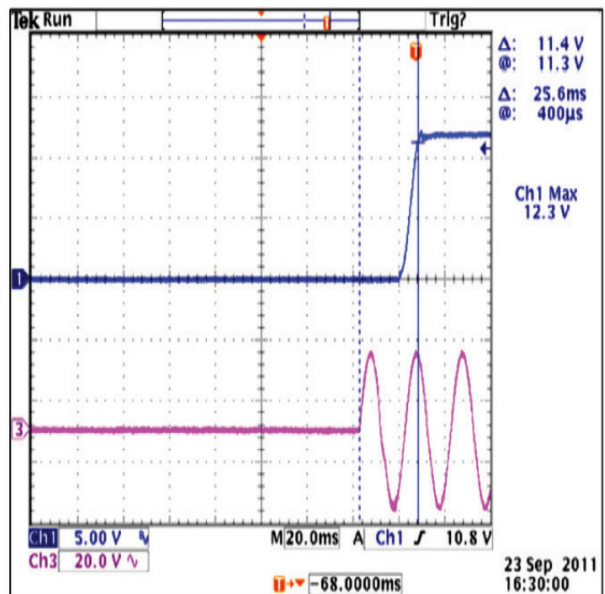

12V OUT, FULL LOAD, 264VAC



For international contact information,
visit [advancedenergy.com](https://www.advancedenergy.com).

powersales@aei.com (Sales Support)
productsupport.ep@aei.com (Technical Support)
+1 888 412 7832

ABOUT ADVANCED ENERGY

Advanced Energy (AE) has devoted more than three decades to perfecting power for its global customers. AE designs and manufactures highly engineered, precision power conversion, measurement and control solutions for mission-critical applications and processes.

Our products enable customer innovation in complex applications for a wide range of industries including semiconductor equipment, industrial, manufacturing, telecommunications, data center computing, and medical. With deep applications know-how and responsive service and support across the globe, we build collaborative partnerships to meet rapid technological developments, propel growth for our customers, and innovate the future of power.

PRECISION | POWER | PERFORMANCE | TRUST

Specifications are subject to change without notice. Not responsible for errors or omissions. ©2023 Advanced Energy Industries, Inc. All rights reserved. Advanced Energy®, and AE® are U.S. trademarks of Advanced Energy Industries, Inc.