

ATA 3W Series

3 Watts

DC/DC Converter

Total Power: 3 Watts
Input Voltage: 9 to 36 Vdc
18 to 75 Vdc

of Outputs: Single, dual

Special Features

- Ultra compact DIP Package
23.8 x 13.7 x 8.0 mm
(0.94 x 0.54 x 0.31 inches)
- Ultra compact SMD Package
24.0 x 13.7 x 8.0 mm
(0.94 x 0.54 x 0.31 inches)
- Efficiency up to 80%
- I/O-isolation 1500VDC
- Ultra-wide 4:1 Input Range
- Operating Temp. Range -40 °C to +85 °C (for DIP module)
- Operating Temp. Range -40 °C to +80 °C (for SMD module)
- Remote On/Off Control
- Input Filter meets EN 55022, class A and FCC, level A
- Qualified for lead-free Reflow Solder Process according IPC/JEDEC J-STD-020D (for SMD module)
- 3 Years Product Warranty

Safety

UL/cUL 60950-1 recognition
(CSA certificate)
IEC/EN 60950-1 (CB-scheme)

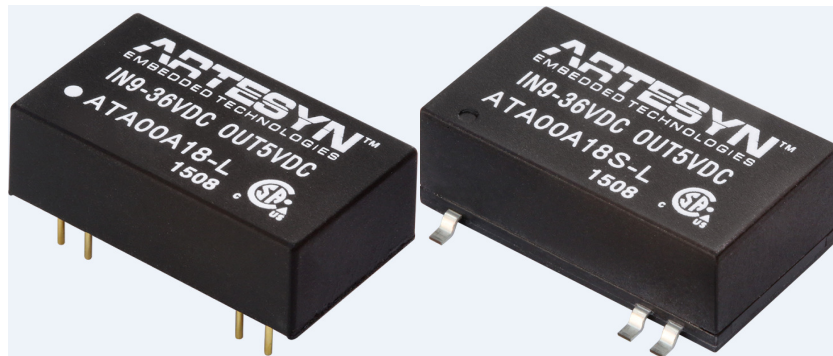

Product Descriptions

The ATA 3W series power modules are in mini-DIP and mini-SMD DC/DC converters that operate over input voltage ranges of 9-36VDC and 18-75VDC which provide precisely regulated output voltages of 3.3V, 5V, 12V, 15V, 24V, $\pm 5V$, $\pm 12V$ and $\pm 15Vdc$.

The ATA 3W series offers a power rating up to 3W and a typical full-load efficiency of 80%, continuous short circuit, remote on/off control, EN55022 Class A conducted noise compliance minimize design-in time, cost and eliminate the need for external filtering.

The ATA 3W series is an excellent selection for data communication equipment, mobile battery driven equipment, distributed power system, telecommunication equipment, mixed analog/digital subsystem, process/machine control equipment, computer peripheral equipment and industrial robot system.

Applications

Distributed power architectures
Workstations
Computer equipment
Communications equipment

Model Numbers

Model	Input Voltage (Vdc)	Output Voltage (Vdc)	Maximum Load (mA)	Efficiency ¹ (%)	Package
ATA00F18-L	9-36	3.3	600	75	DIP
ATA00A18-L	9-36	5	600	78	DIP
ATA00B18-L	9-36	12	250	80	DIP
ATA00C18-L	9-36	15	200	80	DIP
ATA00H18-L	9-36	24	125	80	DIP
ATA00AA18-L	9-36	±5	300	77	DIP
ATA00BB18-L	9-36	±12	125	80	DIP
ATA00CC18-L	9-36	±15	100	80	DIP
ATA00F36-L	18-75	3.3	600	75	DIP
ATA00A36-L	18-75	5	600	78	DIP
ATA00B36-L	18-75	12	250	80	DIP
ATA00C36-L	18-75	15	200	80	DIP
ATA00H36-L	18-75	24	125	80	DIP
ATA00AA36-L	18-75	±5	300	77	DIP
ATA00BB36-L	18-75	±12	125	80	DIP
ATA00CC36-L	18-75	±15	100	80	DIP

Note 1 - Typical value at nominal input voltage and maximum load.

Model	Input Voltage (Vdc)	Output Voltage (Vdc)	Maximum Load (mA)	Efficiency ¹ (%)	Package
ATA00F18S-L	9-36	3.3	600	75	SMD
ATA00A18S-L	9-36	5	600	78	SMD
ATA00B18S-L	9-36	12	250	80	SMD
ATA00C18S-L	9-36	15	200	80	SMD
ATA00H18S-L	9-36	24	125	80	SMD
ATA00AA18S-L	9-36	±5	300	77	SMD
ATA00BB18S-L	9-36	±12	125	80	SMD
ATA00CC18S-L	9-36	±15	100	80	SMD
ATA00F36S-L	18-75	3.3	600	75	SMD
ATA00A36S-L	18-75	5	600	78	SMD
ATA00B36S-L	18-75	12	250	80	SMD
ATA00C36S-L	18-75	15	200	80	SMD
ATA00H36S-L	18-75	24	125	80	SMD
ATA00AA36S-L	18-75	±5	300	77	SMD
ATA00BB36S-L	18-75	±12	125	80	SMD
ATA00CC36S-L	18-75	±15	100	80	SMD

Note 1 – Typical value at nominal input voltage and maximum load.

Options

None

Electrical Specifications

Absolute Maximum Ratings

Stress in excess of those listed in the “Absolute Maximum Ratings” may cause permanent damage to the power supply. These are stress ratings only and functional operation of the unit is not implied at these or any other conditions above those given in the operational sections of this TRN. Exposure to any absolute maximum rated condition for extended periods may adversely affect the power supply’s reliability.

Table 1. Absolute Maximum Ratings:

Parameter	Model	Symbol	Min	Nom	Max	Unit
Input Surge Voltage Transient (for 100ms max)	24V Input Models 48V Input Models	$V_{IN,DC}$	-0.7 -0.7	- -	50 100	Vdc
Maximum Output Power	All models	$P_{O,max}$	-	-	3	W
Isolation Voltage Input to output (60 seconds)	All models		1500	-	-	Vdc
Isolation Resistance	All models		1000	-	-	MΩ
Isolation Capacitance	All models		-	-	500	pF
Operating Ambient Temperature Range (for DIP modules)						
Without derating	All Models		-40	-	+65	°C
With derating	All models		-40	-	+85	
Operating Ambient Temperature Range (for SMD modules)						
Without derating	All models		-40	-	+60	°C
With derating	All models		-40	-	+80	
Operating Case Temperature	All models	T_{CASE}	-40	-	+105	°C
Storage Temperature	All models	T_{STG}	-50	-	+125	°C
Humidity (non-condensing)						
Operating	All models		5	-	95	%
Non-operating	All models		-	-	95	%
MTBF MIL-STD-217F@25°C, Ground Benign	All models		300	-	-	KHours
Lead Temperature (1.5mm from case for 10sec.)			-	-	260	°C

Input Specifications

Table 2. Input Specifications:

Parameter		Condition	Symbol	Min	Nom	Max	Unit
Operating Input Voltage, DC	24V Input Models 48V Input Models	All	$V_{IN,DC}$	9 18	24 48	36 75	Vdc
Start-Up Threshold Voltage	24V Input Models 48V Input Models	All	$V_{IN,start}$	4.5 8.5	6 12	8.5 17	Vdc
Under Voltage Lockout	24V Input Models 48V Input Models	All	$V_{IN,under}$	- -	- -	8 16	Vdc
Input reflected ripple current	All Models	5 to 20MHz, 12uH source impedance	$I_{IN,ripple}$	-	-	5	mApk-pk
No Load Input Current (V_O On, $I_O = 0A$)	ATA00F18-L ATA00A18-L ATA00B18-L ATA00C18-L ATA00H18-L ATA00AA18-L ATA00BB18-L ATA00CC18-L	$V_{IN,DC} = V_{IN,nom}$	I_{IN,no_load}	- - - - - - - -	30 30 30 30 30 30 30 30	- - - - - - - -	mA
	ATA00F36-L ATA00A36-L ATA00B36-L ATA00C36-L ATA00H36-L ATA00AA36-L ATA00BB36-L ATA00CC36-L	$V_{IN,DC} = V_{IN,nom}$	I_{IN,no_load}	- - - - - - - -	20 20 20 20 20 20 20 20	- - - - - - - -	mA
	ATA00F18S-L ATA00A18S-L ATA00B18S-L ATA00C18S-L ATA00H18S-L ATA00AA18S-L ATA00BB18S-L ATA00CC18S-L	$V_{IN,DC} = V_{IN,nom}$	I_{IN,no_load}	- - - - - - - -	30 30 30 30 30 30 30 30	- - - - - - - -	mA
	ATA00F36S-L ATA00A36S-L ATA00B36S-L ATA00C36S-L ATA00H36S-L ATA00AA36S-L ATA00BB36S-L ATA00CC36S-L	$V_{IN,DC} = V_{IN,nom}$	I_{IN,no_load}	- - - - - - - -	20 20 20 20 20 20 20 20	- - - - - - - -	mA

Input Specifications

Table 2. Input Specifications con't:

Parameter		Condition	Symbol	Min	Nom	Max	Unit	
Input Current	ATA00F18-L ATA00A18-L ATA00B18-L ATA00C18-L ATA00H18-L ATA00AA18-L ATA00BB18-L ATA00CC18-L	$V_{IN,DC}=V_{IN,nom}$	$I_{IN,max\ load}$	-	110 160 156 156 156 162 156 156	-	mA	
	ATA00F36-L ATA00A36-L ATA00B36-L ATA00C36-L ATA00H36-L ATA00AA36-L ATA00BB36-L ATA00CC36-L	$V_{IN,DC}=V_{IN,nom}$	$I_{IN,max\ load}$	-	55 80 78 78 78 81 78 78	-	mA	
	ATA00F18S-L ATA00A18S-L ATA00B18S-L ATA00C18S-L ATA00H18S-L ATA00AA18S-L ATA00BB18S-L ATA00CC18S-L	$V_{IN,DC}=V_{IN,nom}$	$I_{IN,max\ load}$	-	110 160 156 156 156 162 156 156	-	mA	
	ATA00F36S-L ATA00A36S-L ATA00B36S-L ATA00C36S-L ATA00H36S-L ATA00AA36S-L ATA00BB36S-L ATA00CC36S-L	$V_{IN,DC}=V_{IN,nom}$	$I_{IN,max\ load}$	-	55 80 78 78 78 81 78 78	-	mA	
	Remote ON/OFF control (Positive logic)	All Models	On-state voltage		2.5	-	5.5	Vdc
			Off-state voltage		-0.7	-	0.8	Vdc
	Standby Input Current	All Models	All	$I_{IN,Standby}$	-	-	5	mA
	Short circuit input power	All Models	All	$P_{IN,short}$	-	-	2000	mW
	Input Current of Remote Control Pin	All Models	All	$I_{IN,remote}$	-	-	-400	uA
	Internal Filter Type				Internal LC Filter (for EN55022,Class A)			

Input Specifications

Table 2. Input Specifications con't:

Parameter		Condition	Symbol	Min	Nom	Max	Unit
Efficiency @Max. Load	ATA00F18-L ATA00A18-L ATA00B18-L ATA00C18-L ATA00H18-L ATA00AA18-L ATA00BB18-L ATA00CC18-L	$V_{IN,DC}=V_{IN,nom}$ $I_O=I_{O,max}$ $T_A=25\text{ }^{\circ}\text{C}$	η	- - - - - - - -	75 78 80 80 80 77 80 80	- - - - - - - -	%
	ATA00F36-L ATA00A36-L ATA00B36-L ATA00C36-L ATA00H36-L ATA00AA36-L ATA00BB36-L ATA00CC36-L	$V_{IN,DC}=V_{IN,nom}$ $I_O=I_{O,max}$ $T_A=25\text{ }^{\circ}\text{C}$	η	- - - - - - - -	75 78 80 80 80 77 80 80	- - - - - - - -	%
	ATA00F18S-L ATA00A18S-L ATA00B18S-L ATA00C18S-L ATA00H18S-L ATA00AA18S-L ATA00BB18S-L ATA00CC18S-L	$V_{IN,DC}=V_{IN,nom}$ $I_O=I_{O,max}$ $T_A=25\text{ }^{\circ}\text{C}$	η	- - - - - - - -	75 78 80 80 80 77 80 80	- - - - - - - -	%
	ATA00F36S-L ATA00A36S-L ATA00B36S-L ATA00C36S-L ATA00H36S-L ATA00AA36S-L ATA00BB36S-L ATA00CC36S-L	$V_{IN,DC}=V_{IN,nom}$ $I_O=I_{O,max}$ $T_A=25\text{ }^{\circ}\text{C}$	η	- - - - - - - -	75 78 80 80 80 77 80 80	- - - - - - - -	%

Output Specifications

Table 3. Output Specifications:

Parameter		Condition	Symbol	Min	Nom	Max	Unit
Output Voltage Setting Accuracy	All Models	$V_{IN,DC}=V_{IN,nom}$ $I_O=50\%$ of $I_{O,max}$	$V_O\%$	-	-	± 2.0	%
Output Voltage Range	ATA00F18-L ATA00A18-L ATA00B18-L ATA00C18-L ATA00H18-L ATA00AA18-L ATA00BB18-L ATA00CC18-L	$V_{IN,DC}=V_{IN,nom}$ $T_A=25\text{ }^\circ\text{C}$	V_O	3.234 4.9 11.76 14.7 23.52 ± 4.9 ± 11.76 ± 14.7	3.3 5 12 15 24 ± 5 ± 12 ± 15	3.366 5.1 12.24 15.3 24.48 ± 5.1 ± 12.24 ± 15.3	Vdc
	ATA00F36-L ATA00A36-L ATA00B36-L ATA00C36-L ATA00H36-L ATA00AA36-L ATA00BB36-L ATA00CC36-L	$V_{IN,DC}=V_{IN,nom}$ $T_A=25\text{ }^\circ\text{C}$	V_O	3.324 4.9 11.76 14.7 23.52 ± 4.9 ± 11.76 ± 14.7	3.3 5 12 15 24 ± 5 ± 12 ± 15	3.366 5.1 12.24 15.3 24.48 ± 5.1 ± 12.24 ± 15.3	Vdc
	ATA00F18S-L ATA00A18S-L ATA00B18S-L ATA00C18S-L ATA00H18S-L ATA00AA18S-L ATA00BB18S-L ATA00CC18S-L	$V_{IN,DC}=V_{IN,nom}$ $T_A=25\text{ }^\circ\text{C}$	V_O	3.324 4.9 11.76 14.7 23.52 ± 4.9 ± 11.76 ± 14.7	3.3 5 12 15 24 ± 5 ± 12 ± 15	3.366 5.1 12.24 15.3 24.48 ± 5.1 ± 12.24 ± 15.3	Vdc
	ATA00F36S-L ATA00A36S-L ATA00B36S-L ATA00C36S-L ATA00H36S-L ATA00AA36S-L ATA00BB36S-L ATA00CC36S-L	$V_{IN,DC}=V_{IN,nom}$ $T_A=25\text{ }^\circ\text{C}$	V_O	3.324 4.9 11.76 14.7 23.52 ± 4.9 ± 11.76 ± 14.7	3.3 5 12 15 24 ± 5 ± 12 ± 15	3.366 5.1 12.24 15.3 24.48 ± 5.1 ± 12.24 ± 15.3	Vdc

Output Specifications

Table 3. Output Specifications con't:

Parameter		Condition	Symbol	Min	Nom	Max	Unit
Output Current	ATA00F18-L	All	I_o	90	-	600	mA
	ATA00A18-L			90	-	600	
	ATA00B18-L			38	-	250	
	ATA00C18-L			30	-	200	
	ATA00H18-L			19	-	125	
	ATA00AA18-L			±45	-	±300	
	ATA00BB18-L			±19	-	±125	
	ATA00CC18-L			±15	-	±100	
	ATA00F36-L	All	I_o	90	-	600	mA
	ATA00A36-L			90	-	600	
	ATA00B36-L			38	-	250	
	ATA00C36-L			30	-	200	
	ATA00H36-L			19	-	125	
	ATA00AA36-L			±45	-	±300	
	ATA00BB36-L			±19	-	±125	
	ATA00CC36-L			±15	-	±100	
	ATA00F18S-L	All	I_o	90	-	600	mA
	ATA00A18S-L			90	-	600	
	ATA00B18S-L			38	-	250	
	ATA00C18S-L			30	-	200	
ATA00H18S-L	19			-	125		
ATA00AA18S-L	±45			-	±300		
ATA00BB18S-L	±19			-	±125		
ATA00CC18S-L	±15			-	±100		
ATA00F36S-L	All	I_o	90	-	600	mA	
ATA00A36S-L			90	-	600		
ATA00B36S-L			38	-	250		
ATA00C36S-L			30	-	200		
ATA00H36S-L			19	-	125		
ATA00AA36S-L			±45	-	±300		
ATA00BB36S-L			±19	-	±125		
ATA00CC36S-L			±15	-	±100		

Output Specifications

Table 3. Output Specifications con't:

Parameter		Condition	Symbol	Min	Nom	Max	Unit
V _O Load Capacitance ¹	ATA00F18-L ATA00A18-L ATA00B18-L ATA00C18-L ATA00H18-L ATA00AA18-L ATA00BB18-L ATA00CC18-L	All		-	-	220 220 47 47 47 47# 47# 47#	uF
	ATA00F36-L ATA00A36-L ATA00B36-L ATA00C36-L ATA00H36-L ATA00AA36-L ATA00BB36-L ATA00CC36-L	All		-	-	220 220 47 47 47 47# 47# 47#	uF
	ATA00F18S-L ATA00A18S-L ATA00B18S-L ATA00C18S-L ATA00H18S-L ATA00AA18S-L ATA00BB18S-L ATA00CC18S-L	All		-	-	220 220 47 47 47 47# 47# 47#	uF
	ATA00F36S-L ATA00A36S-L ATA00B36S-L ATA00C36S-L ATA00H36S-L ATA00AA36S-L ATA00BB36S-L ATA00CC36S-L	All		-	-	220 220 47 47 47 47# 47# 47#	uF

Note 1 – '#' for each output.

Output Specifications

Table 3. Output Specifications con't:

Parameter		Condition	Symbol	Min	Nom	Max	Unit
Output Ripple, pk-pk	All Models	20MHz bandwidth, measured with a 1uF MLCC and a 10uF Tantalum Capacitor	V_O	-	50	100	mVpk-pk
Line Regulation		$V_{IN,DC} = V_{IN,min}$ to $V_{IN,max}$ $I_O = I_{O,max}$	$\pm\%V_O$	-	± 0.5	± 1.0	%
Load Regulation		$I_O = 15\%$ to 100% of max Load	$\pm\%V_O$	-	± 0.5	± 1.2	%
Switching Frequency		All	f_{sw}	-	350	-	KHz
V_O Dynamic Response	Peak Deviation	$I_O = 75\%$ to 100% of max Load	$\pm\%V_O$	-	± 3	± 5	%
	Settling Time		t_s	-	300	600	uSec
Temperature Coefficient		All	$\%/^{\circ}C$	-	± 0.01	± 0.02	%
Output Voltage Overshot		$V_{IN,DC} = V_{IN,min}$ to $V_{IN,max}$ $I_O = I_{O,max}$ $T_A = 25^{\circ}C$	$V_O\%$	-	-	5	%
Output Over Current Protection ¹		All	$\%I_{O,max}$	110	150	-	%FL
Output Short Circuit Protection		All		Continuous			

Note 1 - Continuous and Foldback mode.

ATA00F18-L Performance Curves

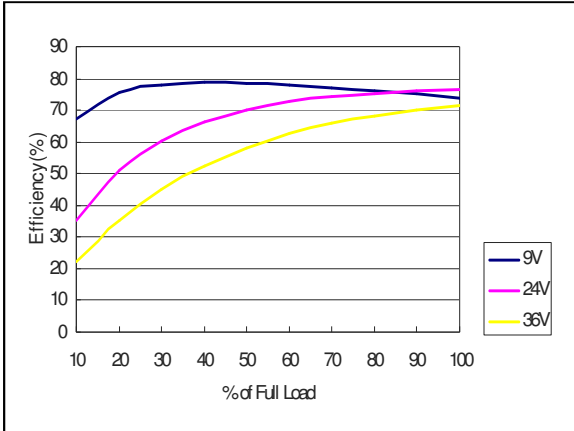

Figure 1: ATA00F18-L Efficiency Versus Output Current Curve
Vin = 9 to 36Vdc, Load: Io = 0 to 0.6A, Ta = 25 °C

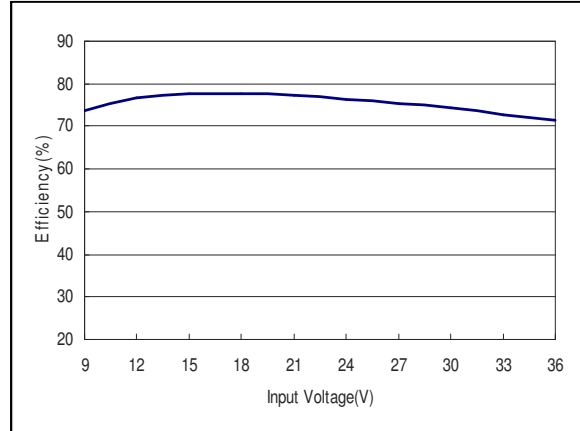

Figure 2: ATA00F18-L Efficiency Versus Input Voltage Curve
Vin = 9 to 36Vdc, Load: Io = 0.6A, Ta = 25 °C

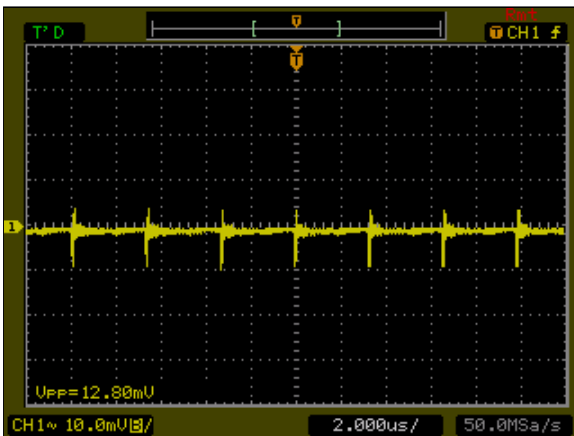

Figure 3: ATA00F18-L Ripple and Noise Measurement
Vin = 24Vdc, Load: Io = 0.6A, Ta = 25 °C
Ch 1: Vo

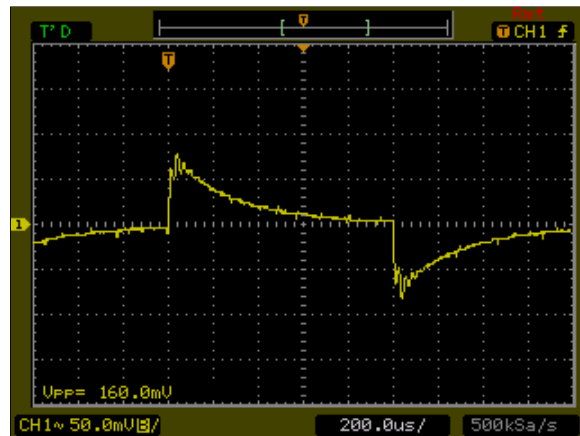

Figure 4: ATA00F18-L Transient Response
Vin = 24Vdc, Load: Io = 100% to 75% load change, Ta = 25 °C
Ch 1: Vo

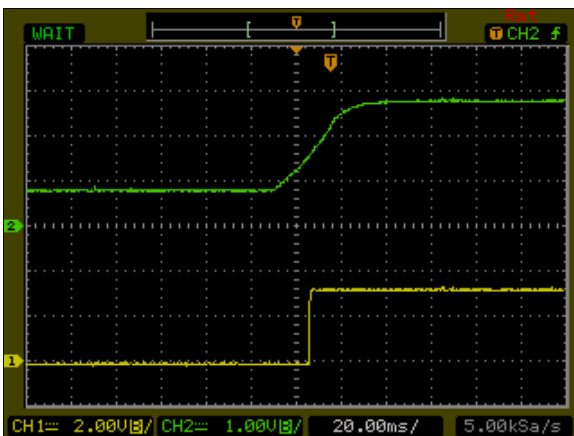

Figure 5: ATA00F18-L Output Voltage Startup Characteristic by Remote
Vin = 24Vdc, Load: Io = 0.6A, Ta = 25 °C
Ch1: Vo
Ch2: Remote On/Off

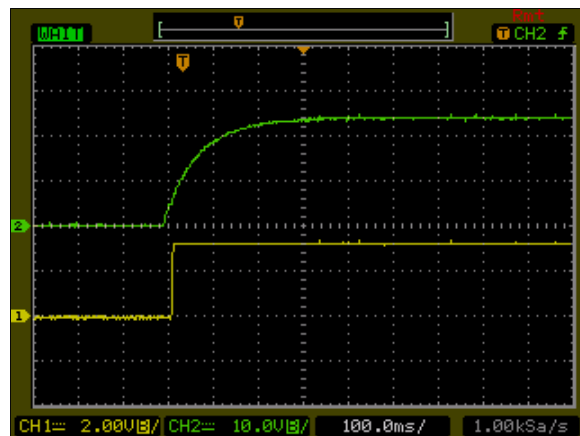

Figure 6: ATA00F18-L Output Voltage Startup Characteristic by Vin
Vin = 24Vdc, Load: Io = 0.6A, Ta = 25 °C
Ch1: Vo
Ch2: Vin

ATA00F18-L Performance Curves

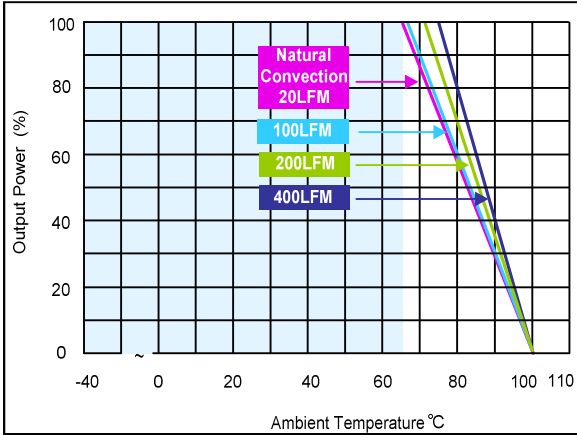

Figure 7: ATA00F18-L Derating Curves
Vin = 24Vdc, Load: Io = 0 to 0.6A, Ta = 25 °C

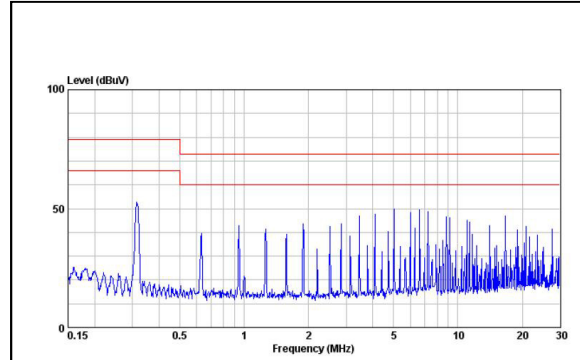

Figure 8: ATA00F18-L Conduction Emission of EN550122 Class A
Vin = 24Vdc, Load: Io = 0.6A, Ta = 25 °C

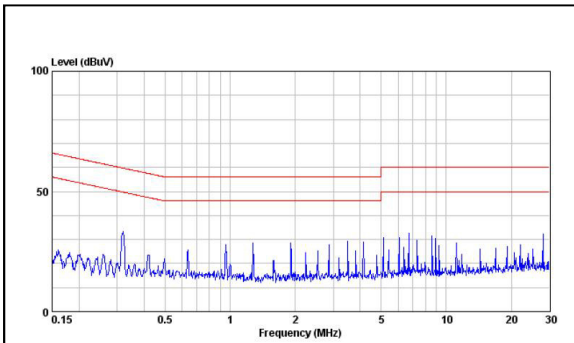

Figure 9: ATA00F18-L Conduction Emission of EN550122 Class B
Vin = 24Vdc, Load: Io = 0.6A, Ta = 25 °C (with external filter)

ATA00A18-L Performance Curves

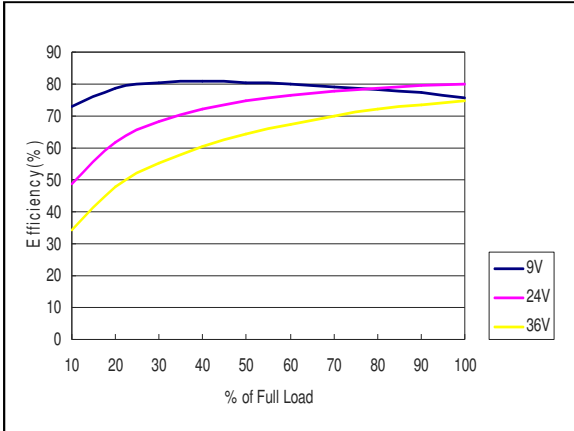

Figure 10: ATA00A18-L Efficiency Versus Output Current Curve
Vin = 9 to 36Vdc, Load: Io = 0 to 0.6A, Ta = 25 °C

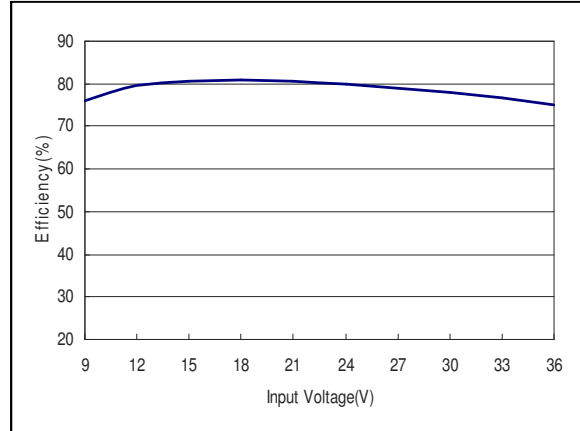

Figure 11: ATA00A18-L Efficiency Versus Input Voltage Curve
Vin = 9 to 36Vdc, Load: Io = 0.6A, Ta = 25 °C

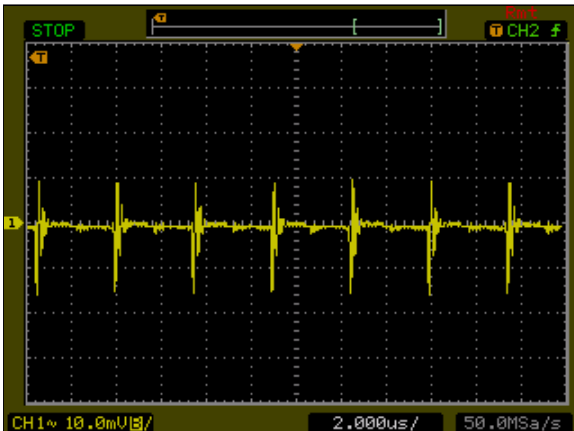

Figure 12: ATA00A18-L Ripple and Noise Measurement
Vin = 24Vdc, Load: Io = 0.6A, Ta = 25 °C
Ch 1: Vo

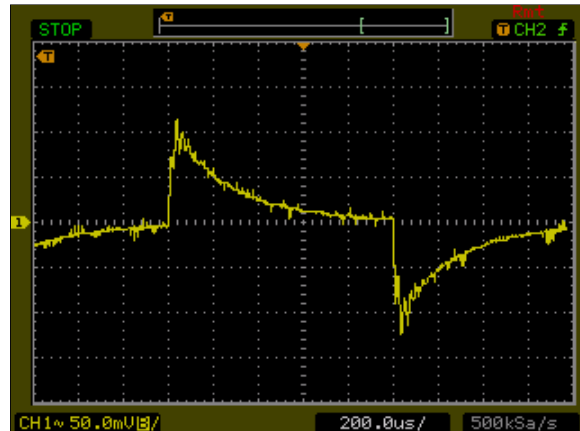

Figure 13: ATA00A18-L Transient Response
Vin = 24Vdc, Load: Io = 100% to 75% load change, Ta = 25 °C
Ch 1: Vo

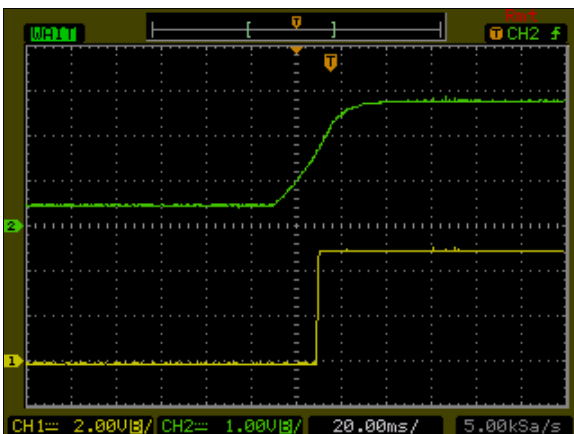

Figure 14: ATA00A18-L Output Voltage Startup Characteristic by Remote
Vin = 24Vdc, Load: Io = 0.6A, Ta = 25 °C
Ch1: Vo
Ch2: Remote On/Off

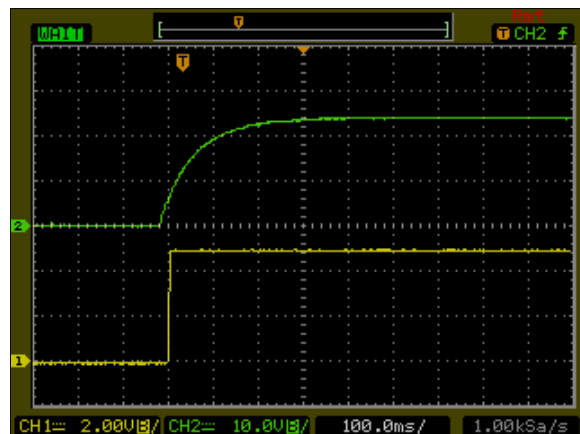

Figure 15: ATA00A18-L Output Voltage Startup Characteristic by Vin
Vin = 24Vdc, Load: Io = 0.6A, Ta = 25 °C
Ch1: Vo
Ch2: Vin

ATA00A18-L Performance Curves

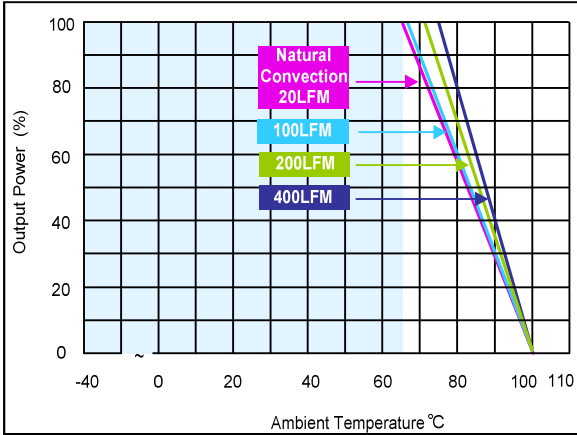

Figure 16: ATA00A18-L Derating Curves
Vin = 24Vdc, Load: Io = 0 to 0.6A, Ta = 25 °C

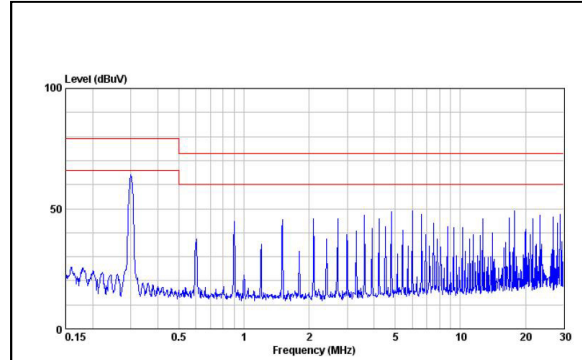

Figure 17: ATA00A18-L Conduction Emission of EN550122 Class A
Vin = 24Vdc, Load: Io = 0.6A, Ta = 25 °C

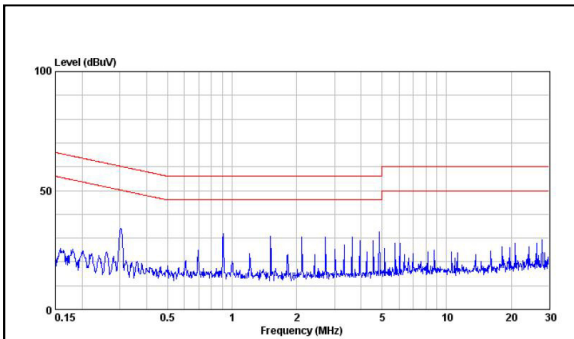

Figure 18: ATA00A18-L Conduction Emission of EN550122 Class B
Vin = 24Vdc, Load: Io = 0.6A, Ta = 25 °C (with external filter)

ATA00B18-L Performance Curves

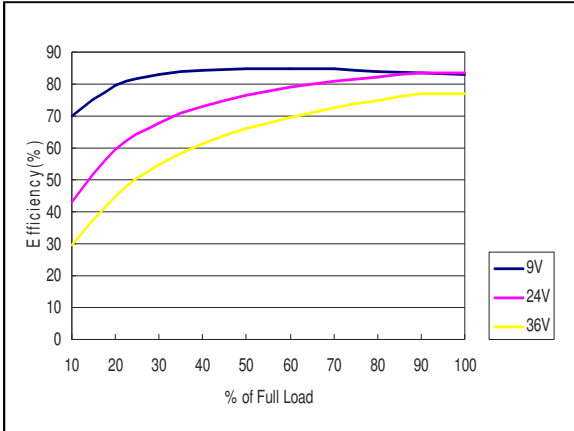

Figure 19: ATA00B18-L Efficiency Versus Output Current Curve
Vin = 9 to 36Vdc, Load: Io = 0 to 0.25A, Ta = 25 °C

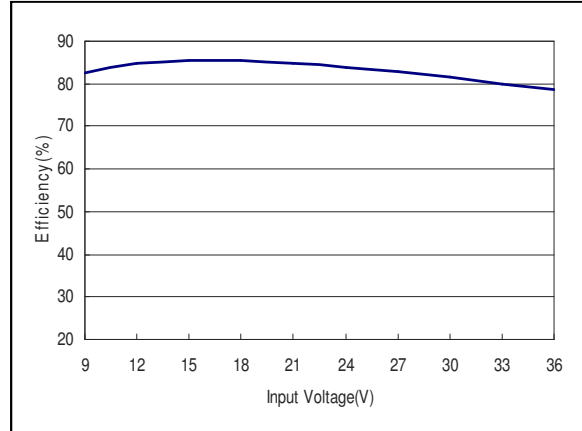

Figure 20: ATA00B18-L Efficiency Versus Input Voltage Curve
Vin = 9 to 36Vdc, Load: Io = 0.25A, Ta = 25 °C

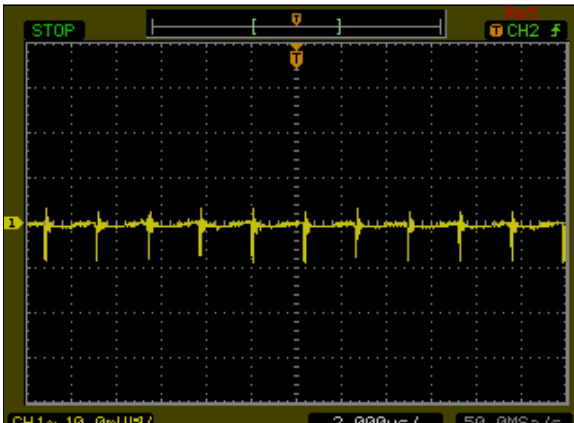

Figure 21: ATA00B18-L Ripple and Noise Measurement
Vin = 24Vdc, Load: Io = 0.25A, Ta = 25 °C
Ch 1: Vo

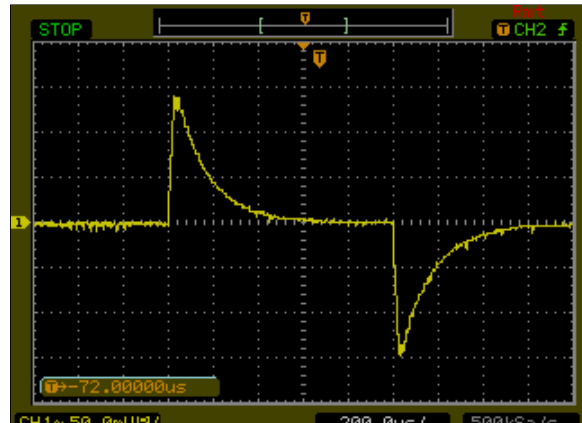

Figure 22: ATA00B18-L Transient Response
Vin = 24Vdc, Load: Io = 100% to 75% load change, Ta = 25 °C
Ch 1: Vo

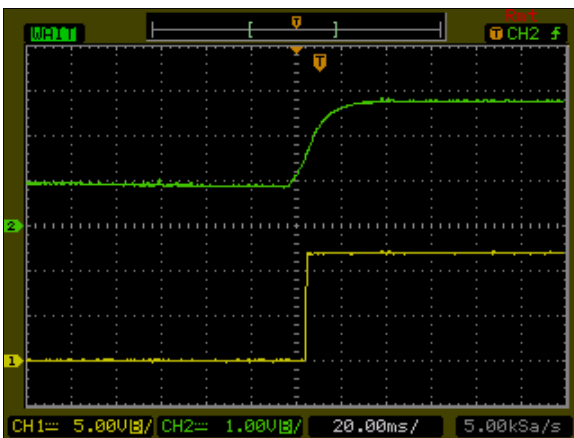

Figure 23: ATA00B18-L Output Voltage Startup Characteristic by Remote
Vin = 24Vdc, Load: Io = 0.25A, Ta = 25 °C
Ch1: Vo
Ch2: Remote On/Off

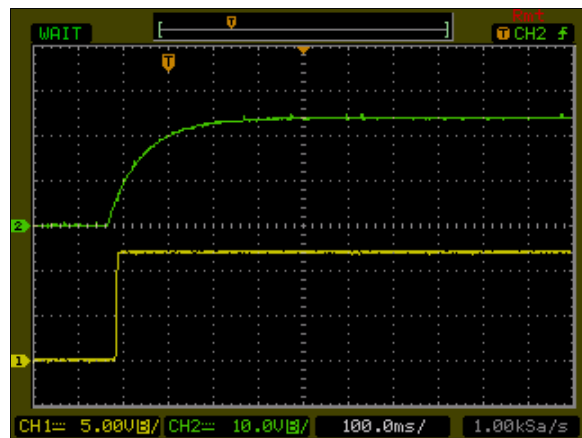

Figure 24: ATA00B18-L Output Voltage Startup Characteristic by Vin
Vin = 24Vdc, Load: Io = 0.25A, Ta = 25 °C
Ch1: Vo
Ch2: Vin

ATA00B18-L Performance Curves

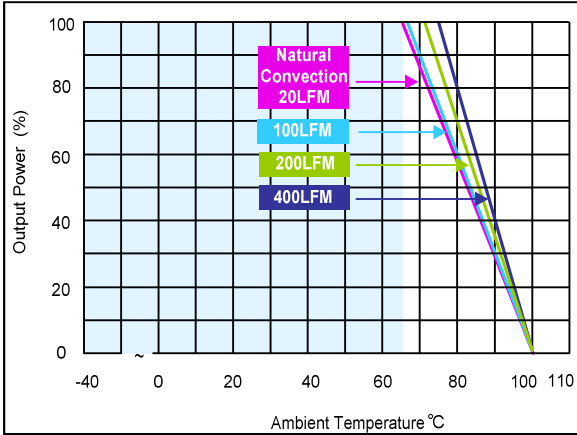

Figure 25: ATA00B18-L Derating Curves
Vin = 24Vdc, Load: Io = 0 to 0.25A, Ta = 25 °C

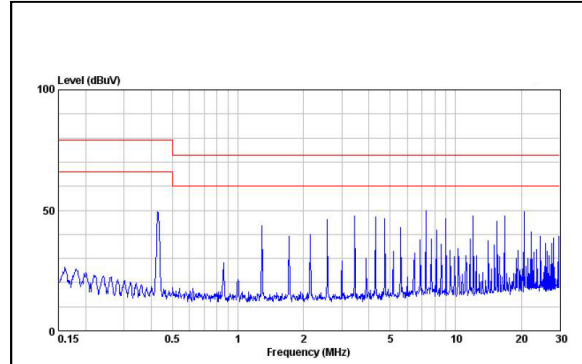

Figure 26: ATA00B18-L Conduction Emission of EN550122 Class A
Vin = 24Vdc, Load: Io = 0.25A, Ta = 25 °C

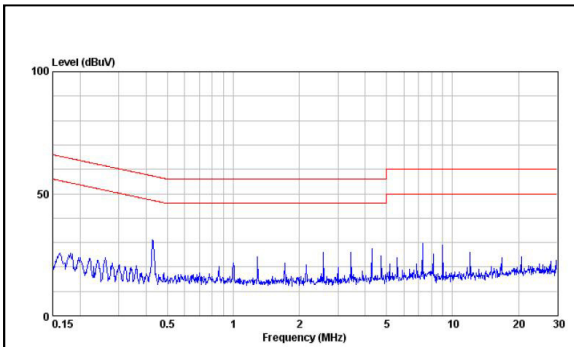

Figure 27: ATA00B18-L Conduction Emission of EN550122 Class B
Vin = 24Vdc, Load: Io = 0.25A, Ta = 25 °C (with external filter)

ATA00C18-L Performance Curves

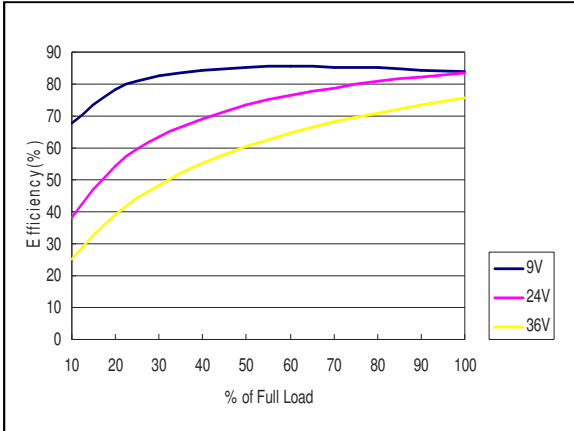

Figure 28: ATA00C18-L Efficiency Versus Output Current Curve
Vin = 9 to 36Vdc, Load: Io = 0 to 0.2A, Ta = 25 °C

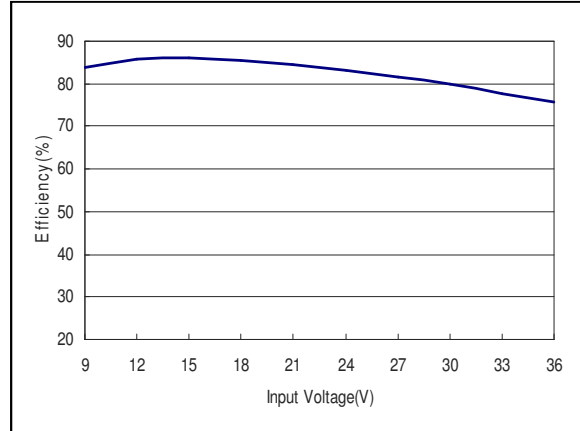

Figure 29: ATA00C18-L Efficiency Versus Input Voltage Curve
Vin = 9 to 36Vdc, Load: Io = 0.2A, Ta = 25 °C

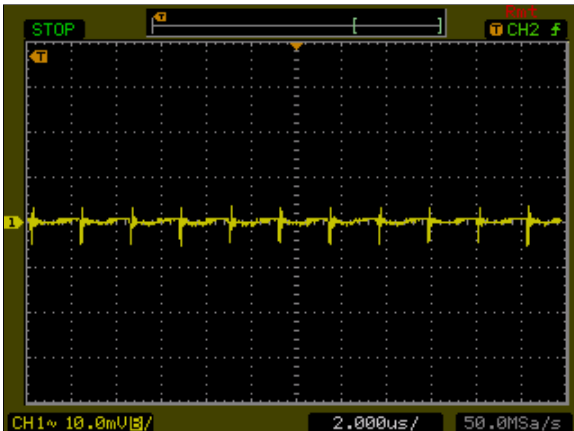

Figure 30: ATA00C18-L Ripple and Noise Measurement
Vin = 24Vdc, Load: Io = 0.2A, Ta = 25 °C
Ch 1: Vo

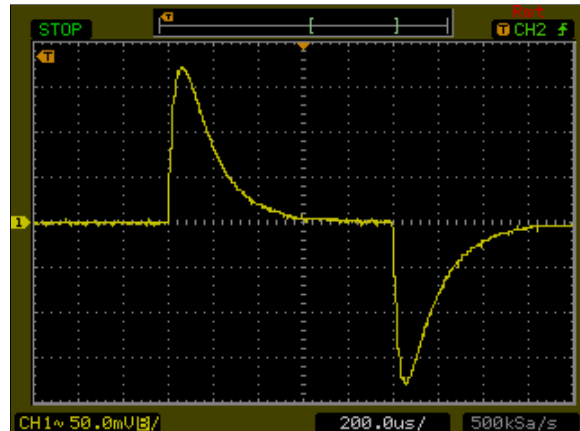

Figure 31: ATA00C18-L Transient Response
Vin = 24Vdc, Load: Io = 100% to 75% load change, Ta = 25 °C
Ch 1: Vo

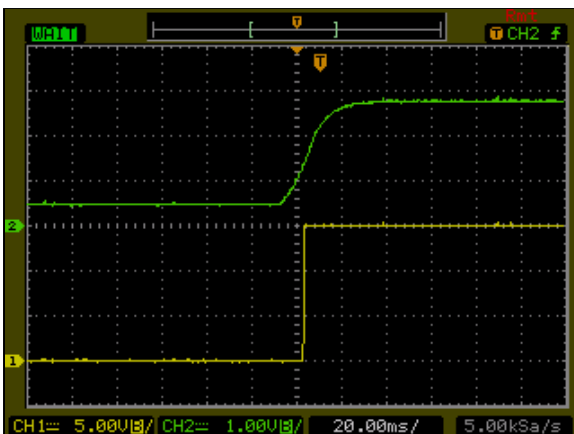

Figure 32: ATA00C18-L Output Voltage Startup Characteristic by Remote
Vin = 24Vdc, Load: Io = 0.2A, Ta = 25 °C
Ch1: Vo
Ch2: Remote On/Off

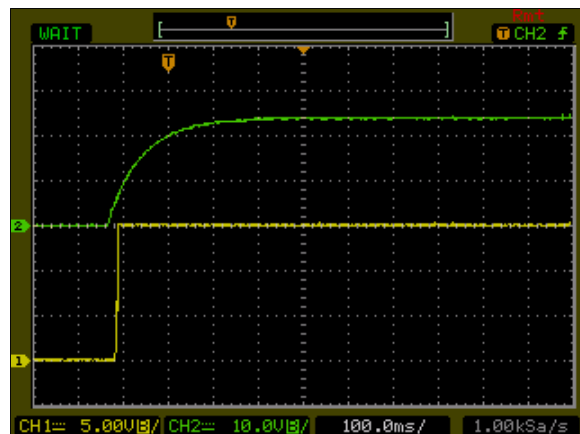

Figure 33: ATA00C18-L Output Voltage Startup Characteristic by Vin
Vin = 24Vdc, Load: Io = 0.2A, Ta = 25 °C
Ch1: Vo
Ch2: Vin

ATA00C18-L Performance Curves

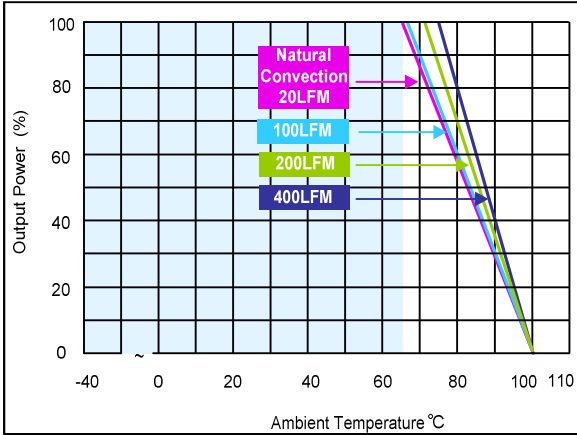

Figure 34: ATA00C18-L Derating Curves
Vin = 24Vdc, Load: Io = 0 to 0.2A, Ta = 25 °C

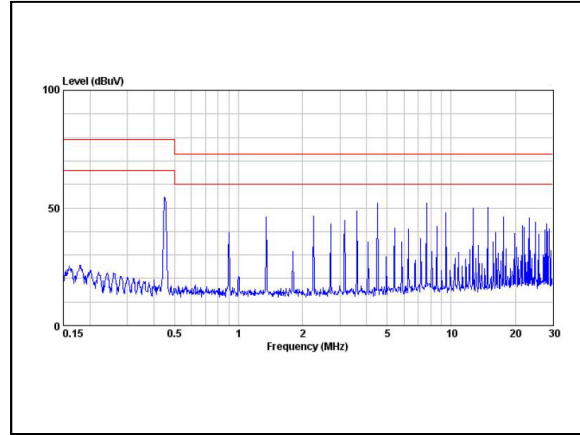

Figure 35: ATA00C18-L Conduction Emission of EN550122 Class A
Vin = 24Vdc, Load: Io = 0.2A, Ta = 25 °C

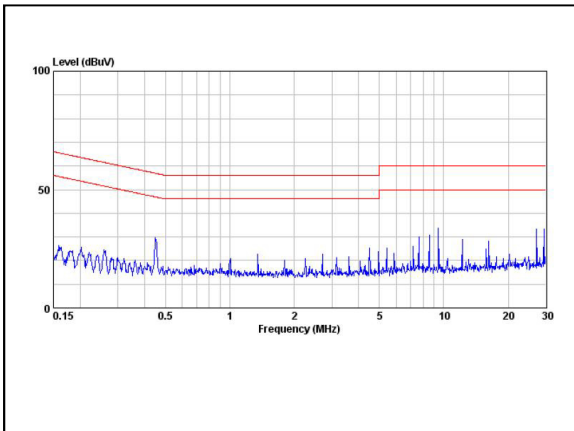

Figure 36: ATA00C18-L Conduction Emission of EN550122 Class B
Vin = 24Vdc, Load: Io = 0.2A, Ta = 25 °C (with external filter)

ATA00H18-L Performance Curves

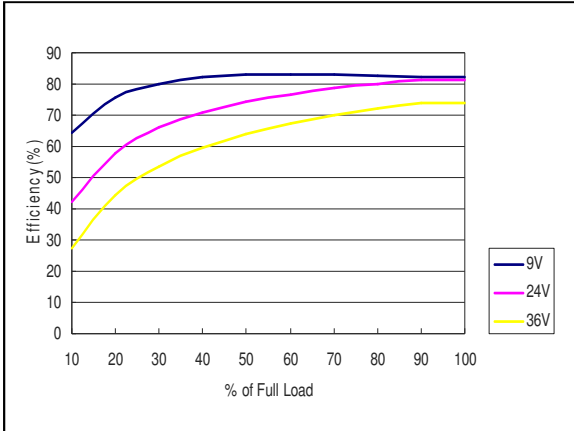

Figure 37: ATA00H18-L Efficiency Versus Output Current Curve
Vin = 9 to 36Vdc, Load: Io = 0 to 0.125A, Ta = 25 °C

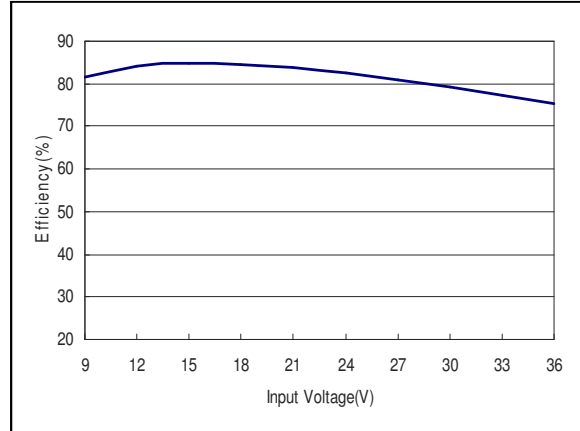

Figure 38: ATA00H18-L Efficiency Versus Input Voltage Curve
Vin = 9 to 36Vdc, Load: Io = 0.125A, Ta = 25 °C

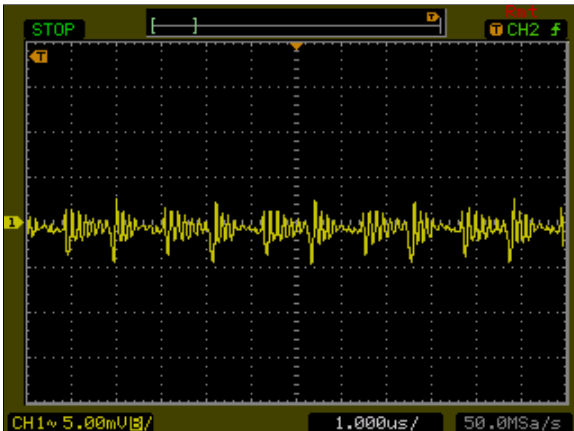

Figure 39: ATA00H18-L Ripple and Noise Measurement
Vin = 24Vdc, Load: Io = 0.125A, Ta = 25 °C
Ch 1: Vo

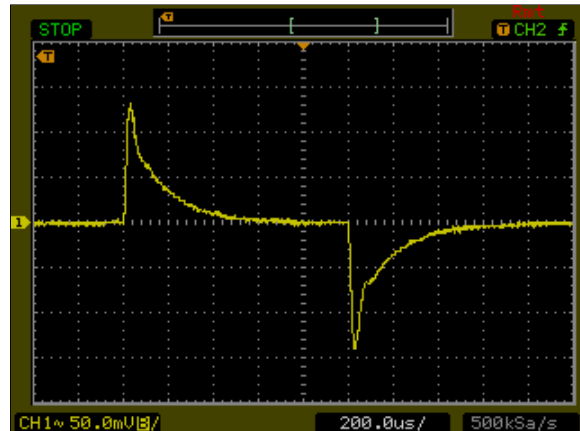

Figure 40: ATA00H18-L Transient Response
Vin = 24Vdc, Load: Io = 100% to 75% load change, Ta = 25 °C
Ch 1: Vo

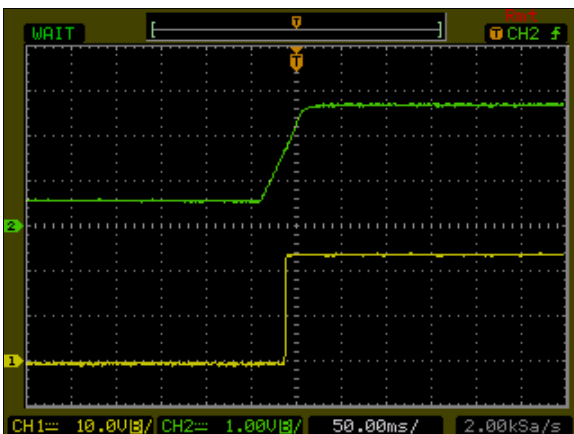

Figure 41: ATA00H18-L Output Voltage Startup Characteristic by Remote
Vin = 24Vdc, Load: Io = 0.125A, Ta = 25 °C
Ch1: Vo
Ch2: Remote On/Off

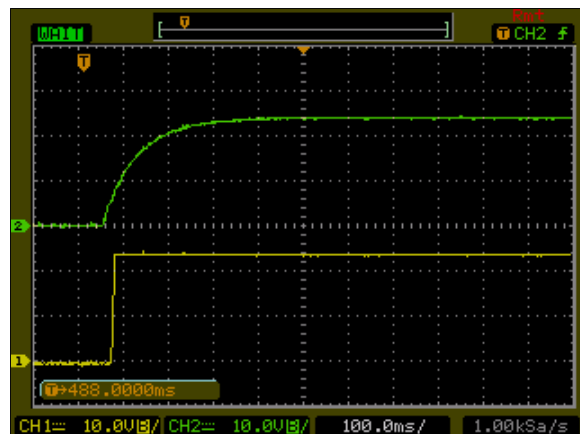

Figure 42: ATA00H18-L Output Voltage Startup Characteristic by Vin
Vin = 24Vdc, Load: Io = 0.125A, Ta = 25 °C
Ch1: Vo
Ch2: Vin

ATA00H18-L Performance Curves

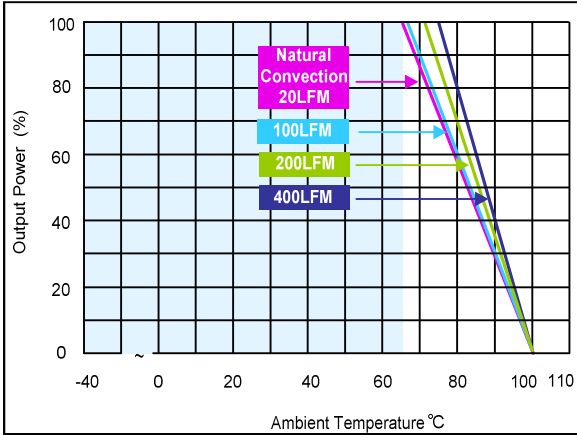

Figure 43: ATA00H18-L Derating Curves
Vin = 24Vdc, Load: Io = 0 to 0.125A, Ta = 25 °C

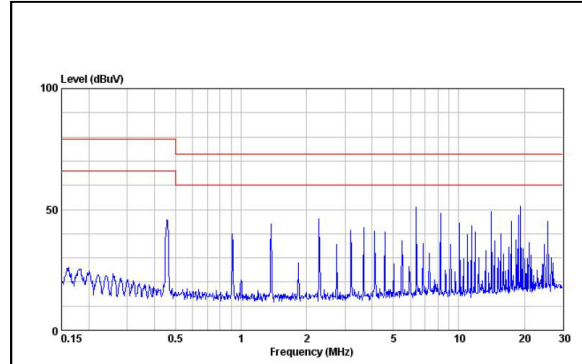

Figure 44: ATA00H18-L Conduction Emission of EN550122 Class A
Vin = 24Vdc, Load: Io = 0.125A, Ta = 25 °C

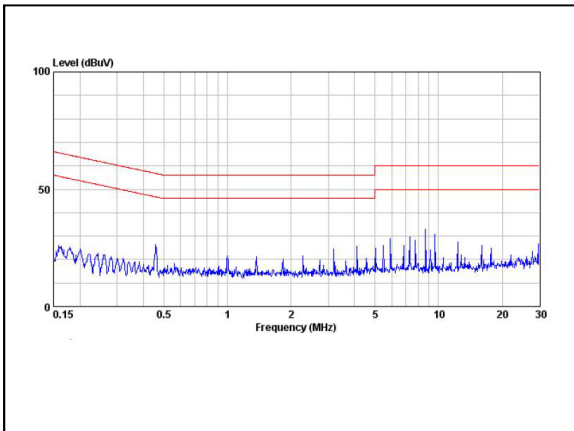

Figure 45: ATA00H18-L Conduction Emission of EN550122 Class B
Vin = 24Vdc, Load: Io = 0.125A, Ta = 25 °C (with external filter)

ATA00AA18-L Performance Curves

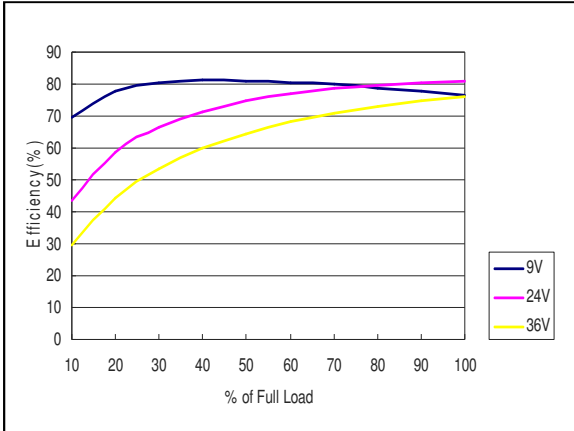

Figure 46: ATA00AA18-L Efficiency Versus Output Current Curve
Vin = 9 to 36Vdc, Load: Io = 0 to ±0.3A, Ta = 25 °C

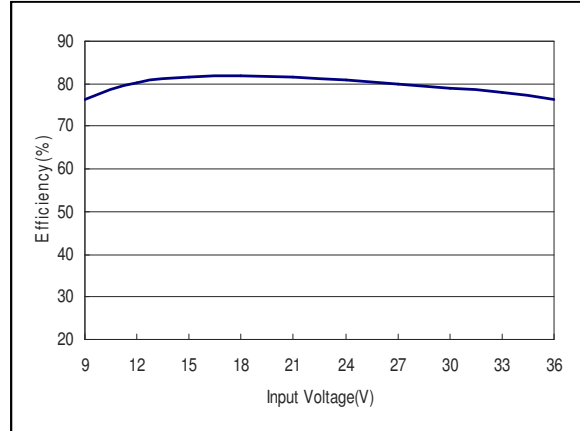

Figure 47: ATA00AA18-L Efficiency Versus Input Voltage Curve
Vin = 9 to 36Vdc, Load: Io = ±0.3A, Ta = 25 °C

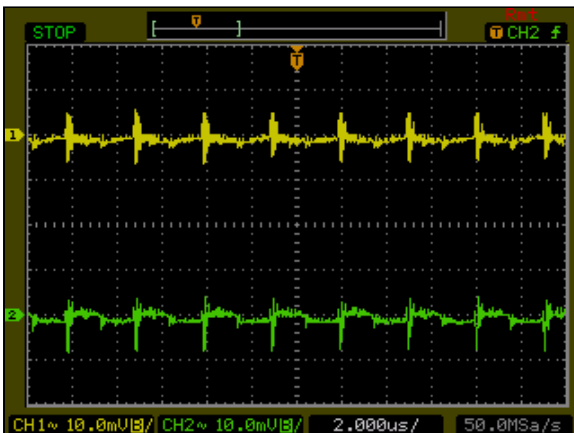

Figure 48: ATA00AA18-L Ripple and Noise Measurement
Vin = 24Vdc, Load: Io = ±0.3A, Ta = 25 °C
Ch 1: V1
Ch 2: V2

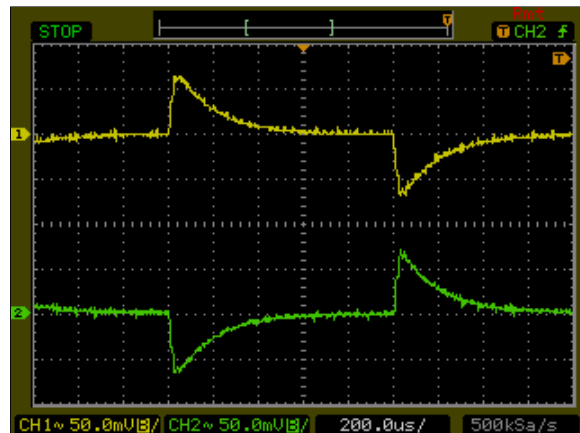

Figure 49: ATA00AA18-L Transient Response
Vin = 24Vdc, Load: Io = 100% to 75% load change, Ta = 25 °C
Ch 1: V1
Ch 2: V2

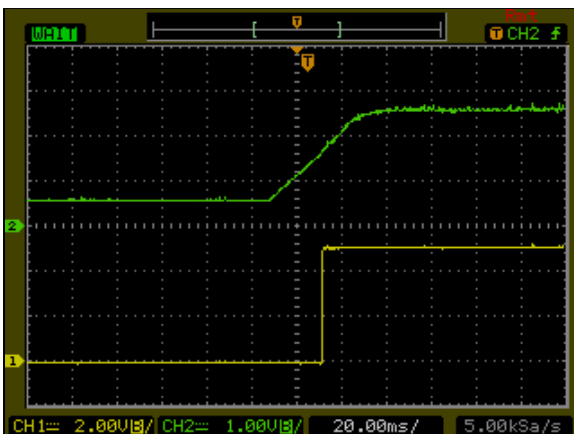

Figure 50: ATA00AA18-L Output Voltage Startup Characteristic by Remote
Vin = 24Vdc, Load: Io = ±0.3A, Ta = 25 °C
Ch1: Vo
Ch2: Remote On/Off

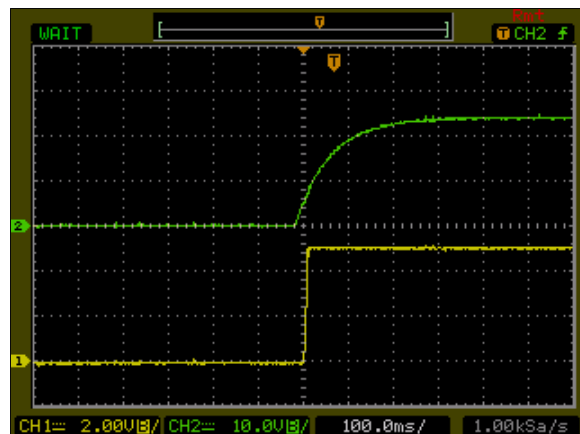

Figure 51: ATA00AA18-L Output Voltage Startup Characteristic by Vin
Vin = 24Vdc, Load: Io = ±0.3A, Ta = 25 °C
Ch1: Vo
Ch2: Vin

ATA00AA18-L Performance Curves

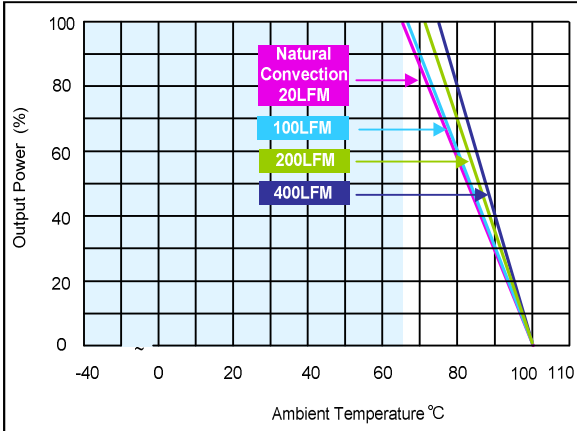

Figure 52: ATA00AA18-L Derating Curves
Vin = 24Vdc, Load: Io = 0 to ±0.3A, Ta = 25 °C

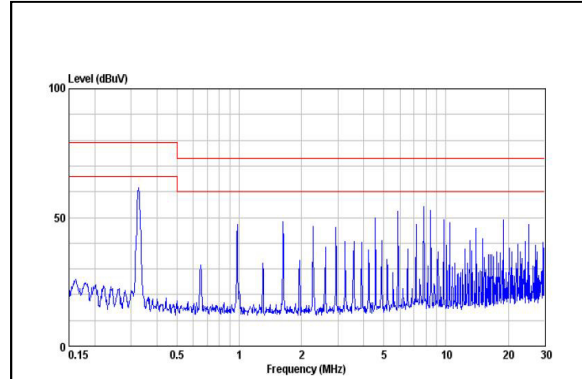

Figure 53: ATA00AA18-L Conduction Emission of EN550122 Class A
Vin = 24Vdc, Load: Io = ±0.3A, Ta = 25 °C

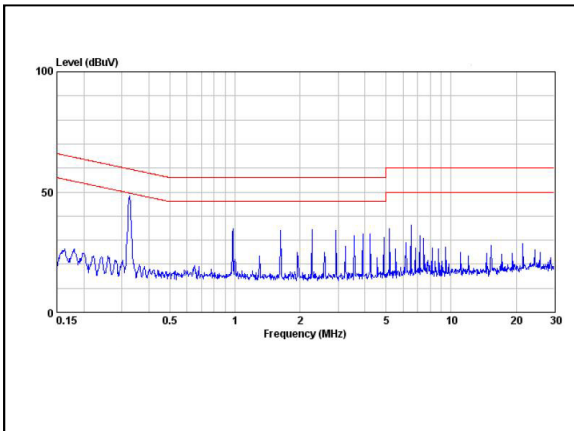

Figure 54: ATA00AA18-L Conduction Emission of EN550122 Class B
Vin = 24Vdc, Load: Io = ±0.3A, Ta = 25 °C (with external filter)

ATA00BB18-L Performance Curves

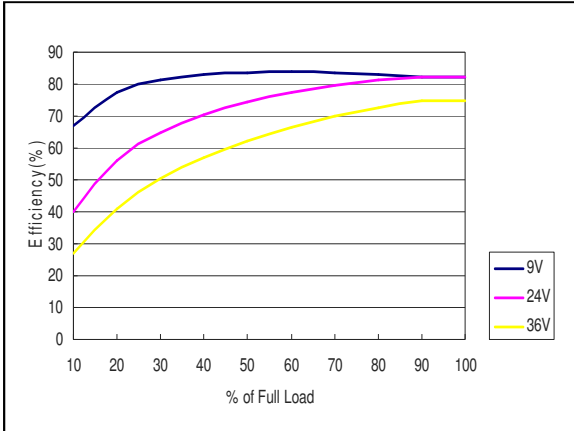

Figure 55: ATA00BB18-L Efficiency Versus Output Current Curve
Vin = 9 to 36Vdc, Load: Io = 0 to ±0.125A, Ta = 25 °C

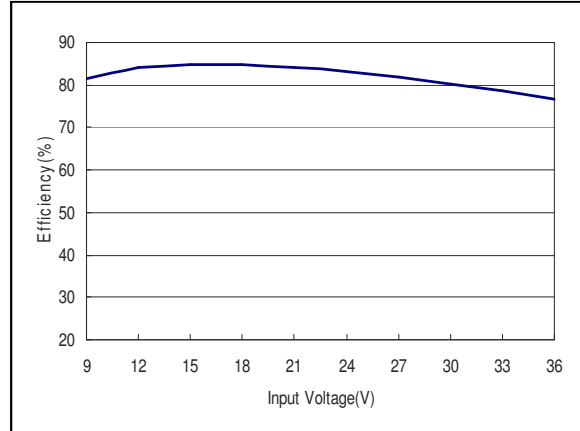

Figure 56: ATA00BB18-L Efficiency Versus Input Voltage Curve
Vin = 9 to 36Vdc, Load: Io = ±0.125A, Ta = 25 °C

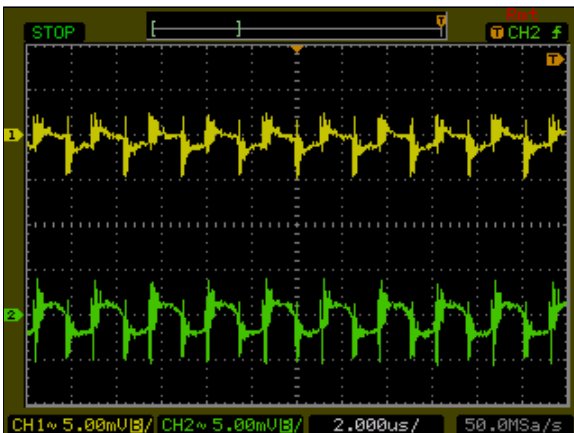

Figure 57: ATA00BB18-L Ripple and Noise Measurement
Vin = 24Vdc, Load: Io = ±0.125A, Ta = 25 °C
Ch 1: V1
Ch 2: V2

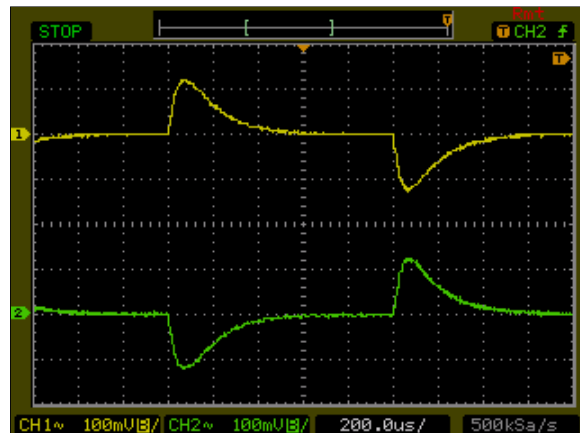

Figure 58: ATA00BB18-L Transient Response
Vin = 24Vdc, Load: Io = 100% to 75% load change, Ta = 25 °C
Ch 1: V1
Ch 2: V2

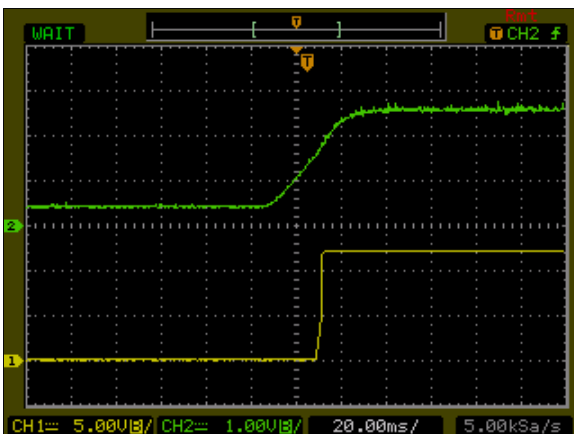

Figure 59: ATA00BB18-L Output Voltage Startup Characteristic by Remote
Vin = 24Vdc, Load: Io = ±0.125A, Ta = 25 °C
Ch1: V1
Ch2: Remote On/Off

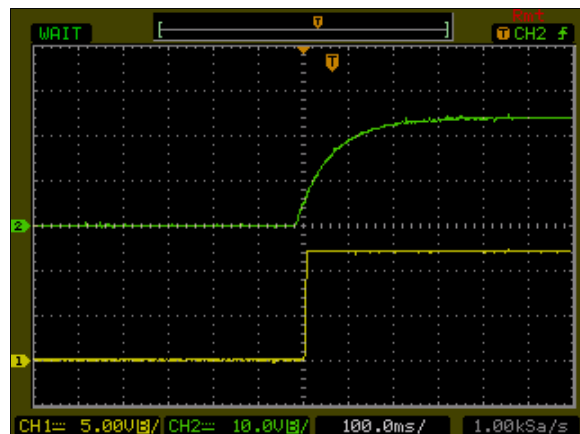

Figure 60: ATA00BB18-L Output Voltage Startup Characteristic by Vin
Vin = 24Vdc, Load: Io = ±0.125A, Ta = 25 °C
Ch1: V1
Ch2: Vin

ATA00BB18-L Performance Curves

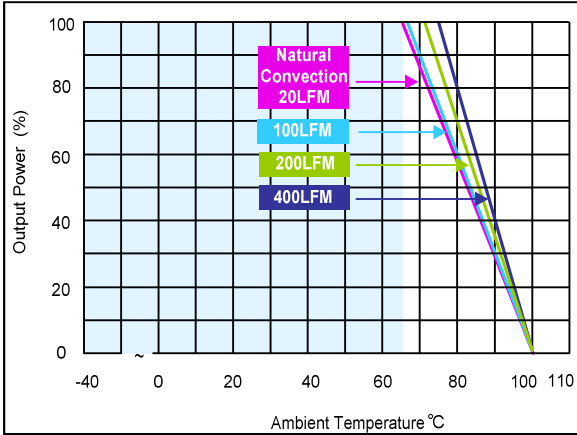

Figure 61: ATA00BB18-L Derating Curves
Vin = 24Vdc, Load: Io = 0 to ±0.125A, Ta = 25 °C

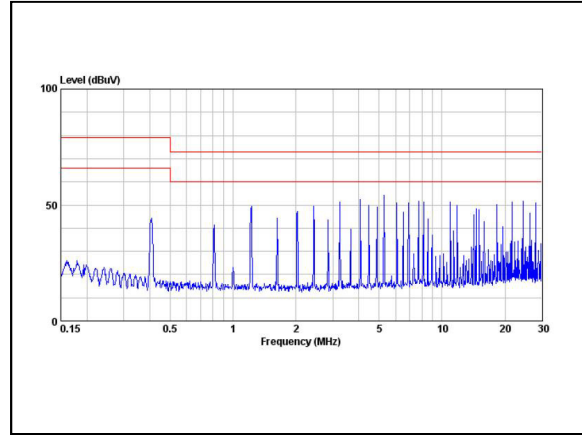

Figure 62: ATA00BB18-L Conduction Emission of EN550122 Class A
Vin = 24Vdc, Load: Io = ±0.125A, Ta = 25 °C

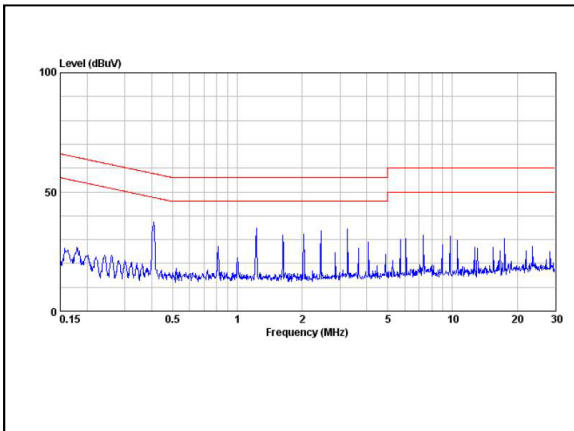

Figure 63: ATA00BB18-L Conduction Emission of EN550122 Class B
Vin = 24Vdc, Load: Io = ±0.125A, Ta = 25 °C (with external filter)

ATA00CC18-L Performance Curves

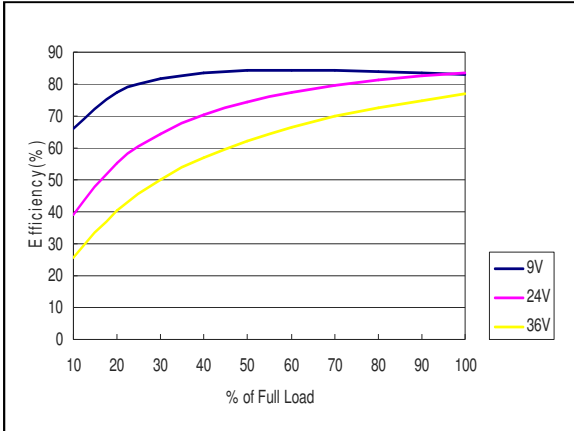

Figure 64: ATA00CC18-L Efficiency Versus Output Current Curve
Vin = 9 to 36Vdc, Load: Io = 0 to ±0.1A, Ta = 25 °C

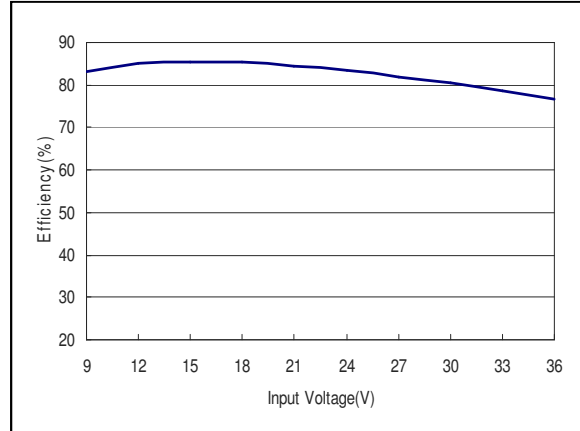

Figure 65: ATA00CC18-L Efficiency Versus Input Voltage Curve
Vin = 9 to 36Vdc, Load: Io = ±0.1A, Ta = 25 °C

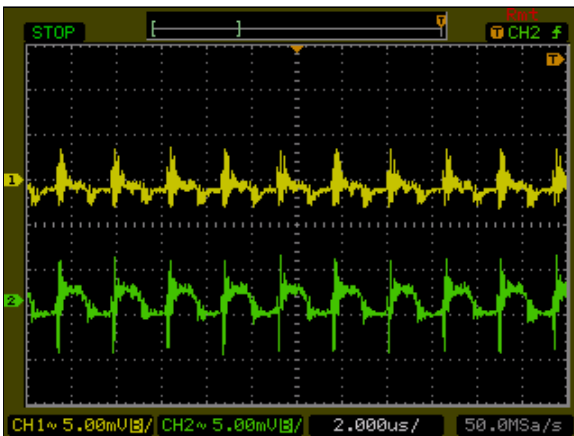

Figure 66: ATA00CC18-L Ripple and Noise Measurement
Vin = 24Vdc, Load: Io = ±0.1A, Ta = 25 °C
Ch 1: V1
Ch 2: V2

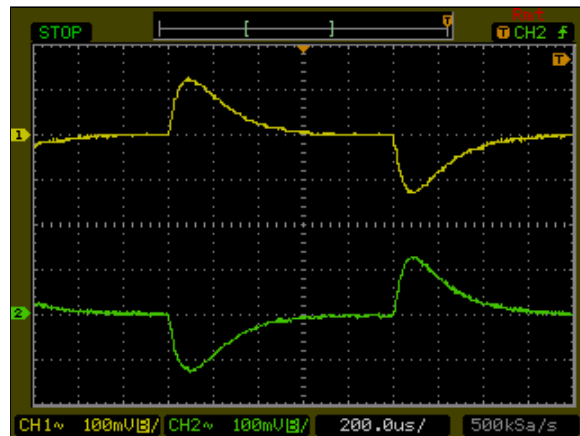

Figure 67: ATA00CC18-L Transient Response
Vin = 24Vdc, Load: Io = 100% to 75% load change, Ta = 25 °C
Ch 1: V1
Ch 2: V2

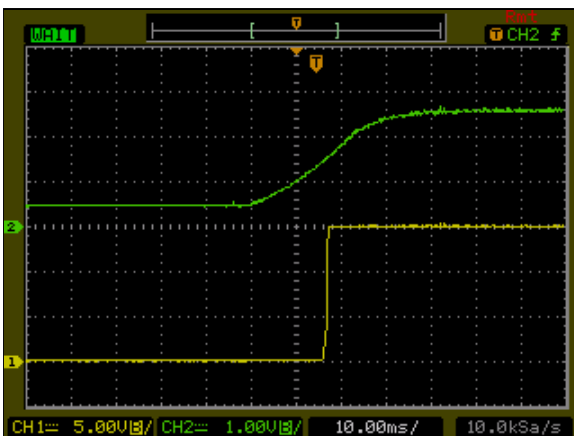

Figure 68: ATA00CC18-L Output Voltage Startup Characteristic by Remote
Vin = 24Vdc, Load: Io = ±0.1A, Ta = 25 °C
Ch1: V1
Ch2: Remote On/Off

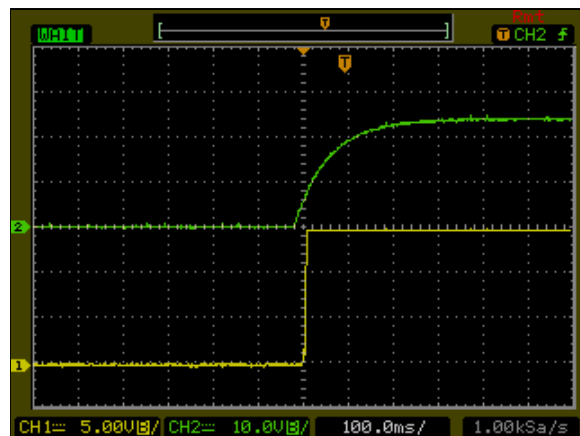

Figure 69: ATA00CC18-L Output Voltage Startup Characteristic by Vin
Vin = 24Vdc, Load: Io = ±0.1A, Ta = 25 °C
Ch1: V1
Ch2: Vin

ATA00CC18-L Performance Curves

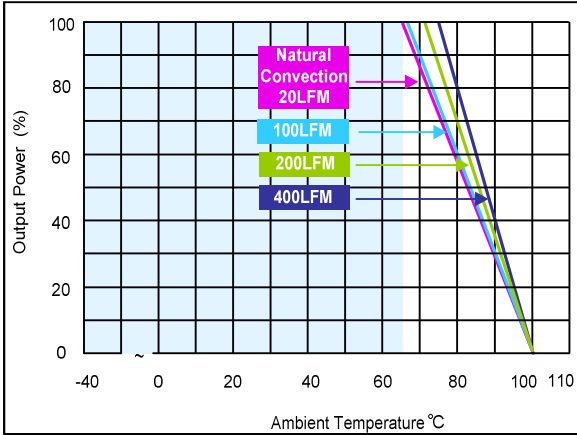

Figure 70: ATA00CC18-L Derating Curves
Vin = 24Vdc, Load: Io = 0 to ±0.1A, Ta = 25 °C

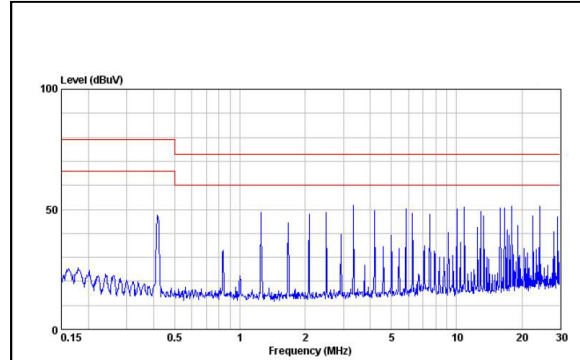

Figure 71: ATA00CC18-L Conduction Emission of EN550122 Class A
Vin = 24Vdc, Load: Io = ±0.1A, Ta = 25 °C

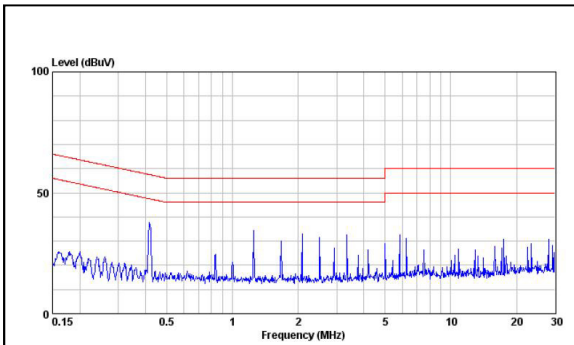

Figure 72: ATA00CC18-L Conduction Emission of EN550122 Class B
Vin = 24Vdc, Load: Io = ±0.1A, Ta = 25 °C (with external filter)

ATA00F36-L Performance Curves

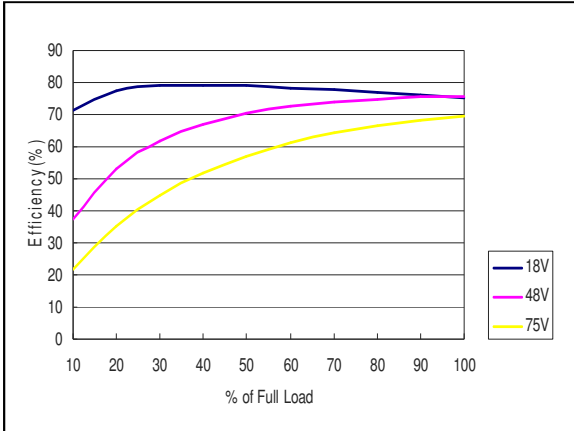

Figure 73: ATA00F36-L Efficiency Versus Output Current Curve
Vin = 18 to 75Vdc, Load: Io = 0 to 0.6A, Ta = 25 °C

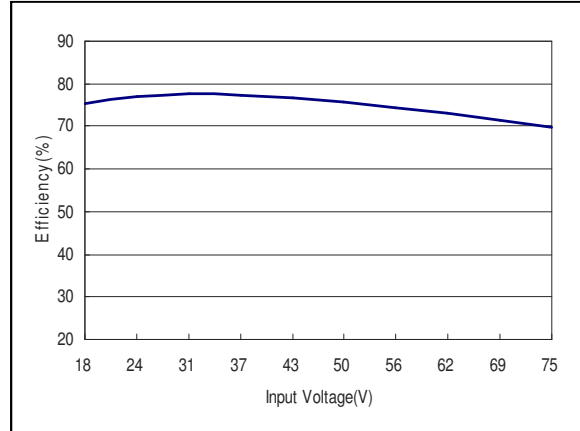

Figure 74: ATA00F36-L Efficiency Versus Input Voltage Curve
Vin = 18 to 75Vdc, Load: Io = 0.6A, Ta = 25 °C

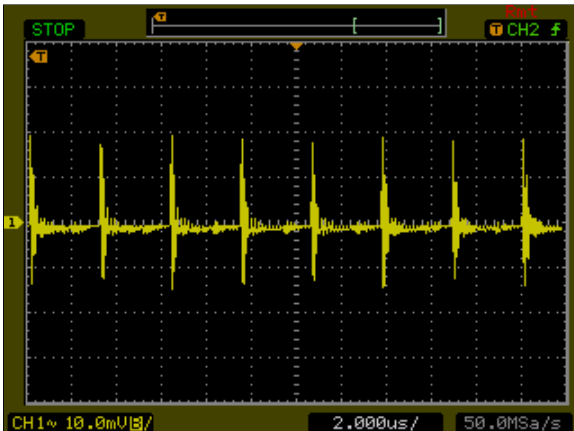

Figure 75: ATA00F36-L Ripple and Noise Measurement
Vin = 48Vdc, Load: Io = 0.6A, Ta = 25 °C
Ch 1: Vo

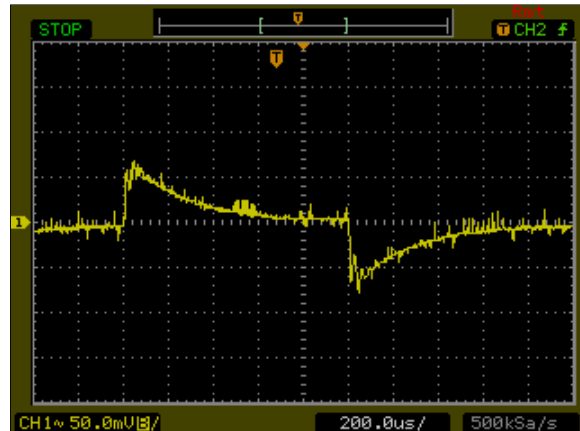

Figure 76: ATA00F36-L Transient Response
Vin = 48Vdc, Load: Io = 100% to 75% load change, Ta = 25 °C
Ch 1: Vo

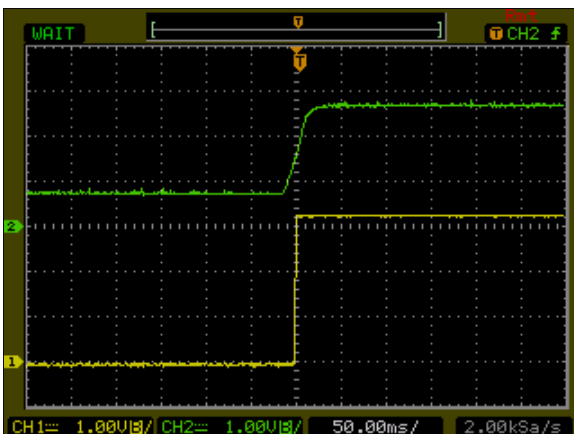

Figure 77: ATA00F36-L Output Voltage Startup Characteristic by Remote
Vin = 48Vdc, Load: Io = 0.6A, Ta = 25 °C
Ch1: Vo
Ch2: Remote On/Off

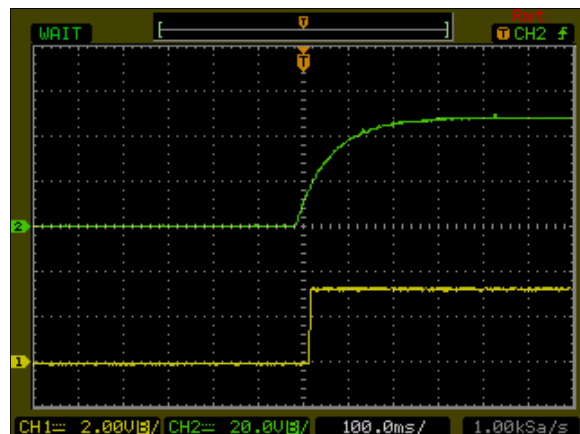

Figure 78: ATA00F36-L Output Voltage Startup Characteristic by Vin
Vin = 48Vdc, Load: Io = 0.6A, Ta = 25 °C
Ch1: Vo
Ch2: Vin

ATA00F36-L Performance Curves

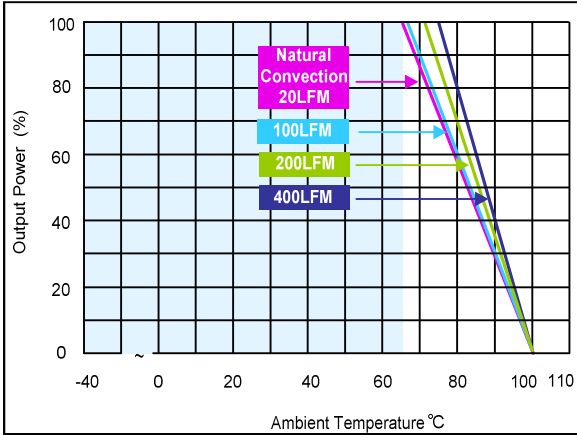

Figure 79: ATA00F36-L Derating Curves
Vin = 48Vdc, Load: Io = 0 to 0.6A, Ta = 25 °C

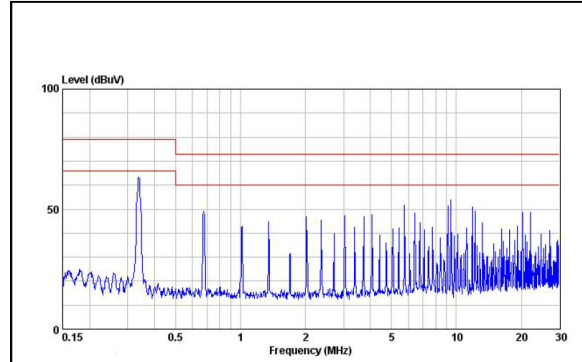

Figure 80: ATA00F36-L Conduction Emission of EN550122 Class A
Vin = 48Vdc, Load: Io = 0.6A, Ta = 25 °C

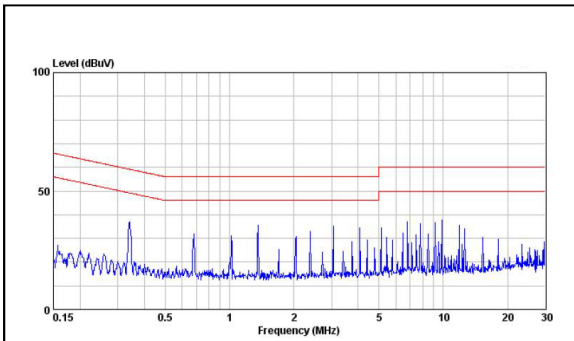

Figure 81: ATA00F36-L Conduction Emission of EN550122 Class B
Vin = 48Vdc, Load: Io = 0.6A, Ta = 25 °C (with external filter)

ATA00A36-L Performance Curves

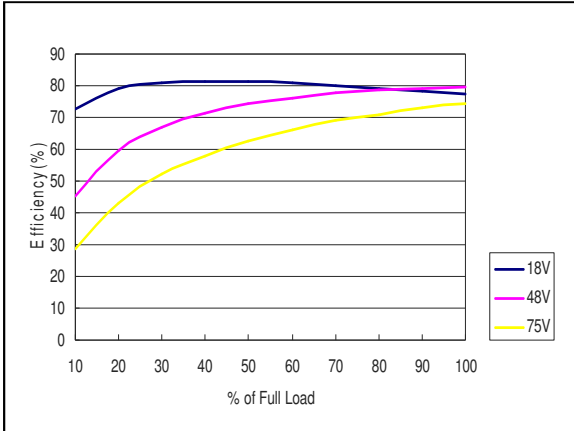

Figure 82: ATA00A36-L Efficiency Versus Output Current Curve
Vin = 18 to 75Vdc, Load: Io = 0 to 0.6A, Ta = 25 °C

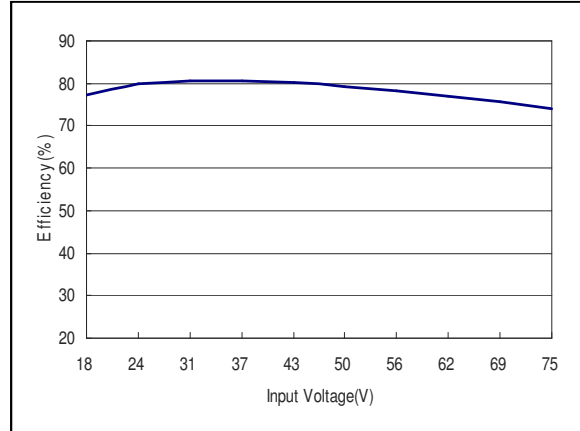

Figure 83: ATA00A36-L Efficiency Versus Input Voltage Curve
Vin = 18 to 75Vdc, Load: Io = 0.6A, Ta = 25 °C

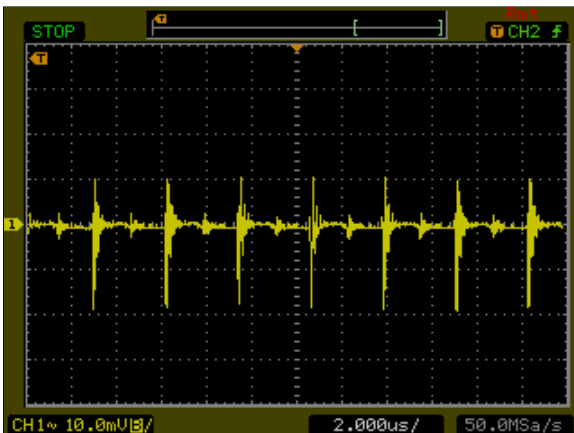

Figure 84: ATA00A36-L Ripple and Noise Measurement
Vin = 48Vdc, Load: Io = 0.6A, Ta = 25 °C
Ch 1: Vo

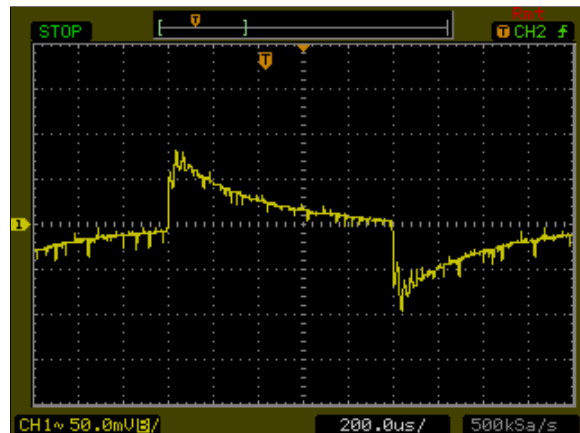

Figure 85: ATA00A36-L Transient Response
Vin = 48Vdc, Load: Io = 100% to 75% load change, Ta = 25 °C
Ch 1: Vo

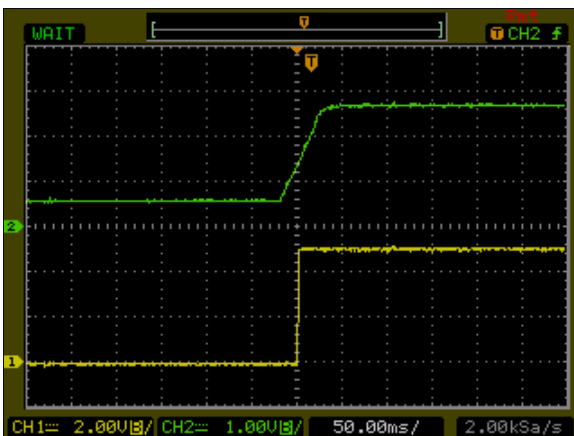

Figure 86: ATA00A36-L Output Voltage Startup Characteristic by Remote
Vin = 48Vdc, Load: Io = 0.6A, Ta = 25 °C
Ch1: Vo
Ch2: Remote On/Off

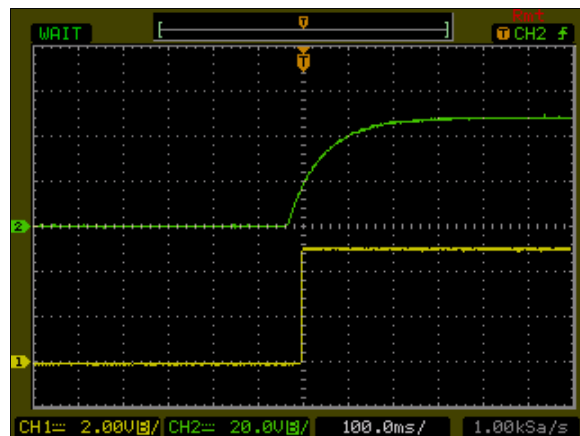

Figure 87: ATA00A36-L Output Voltage Startup Characteristic by Vin
Vin = 48Vdc, Load: Io = 0.6A, Ta = 25 °C
Ch1: Vo
Ch2: Vin

ATA00A36-L Performance Curves

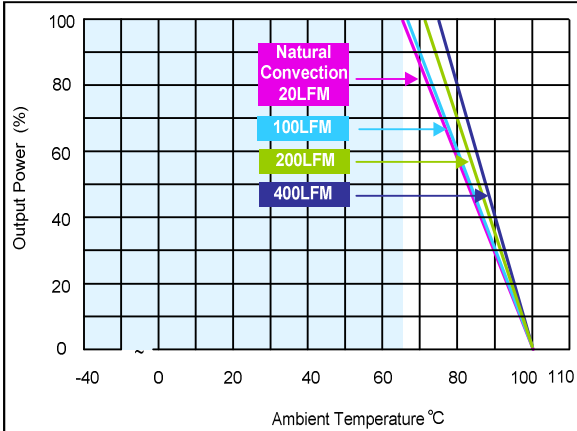

Figure 88: ATA00A36-L Derating Curves
Vin = 48Vdc, Load: Io = 0 to 0.6A, Ta = 25 °C

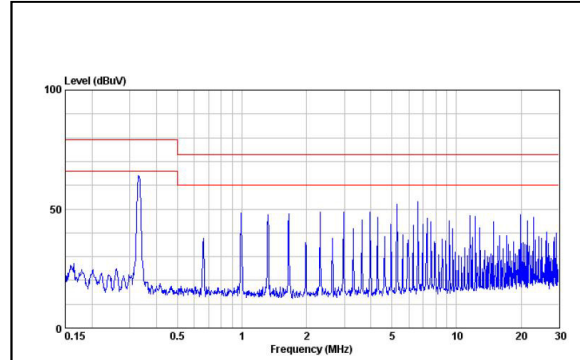

Figure 89: ATA00A36-L Conduction Emission of EN550122 Class A
Vin = 48Vdc, Load: Io = 0.6A, Ta = 25 °C

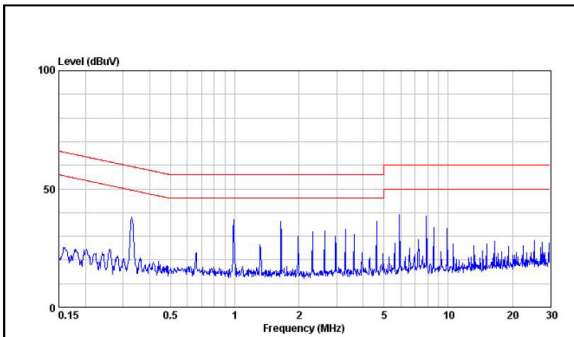

Figure 90: ATA00A36-L Conduction Emission of EN550122 Class B
Vin = 48Vdc, Load: Io = 0.6A, Ta = 25 °C (with external filter)

ATA00B36-L Performance Curves

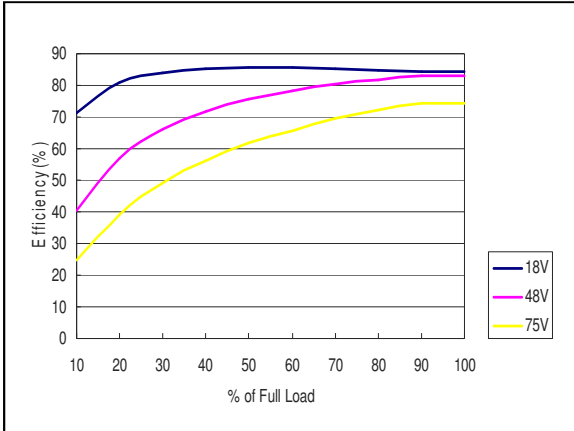

Figure 91: ATA00B36-L Efficiency Versus Output Current Curve
Vin = 18 to 75Vdc, Load: Io = 0 to 0.25A, Ta = 25 °C

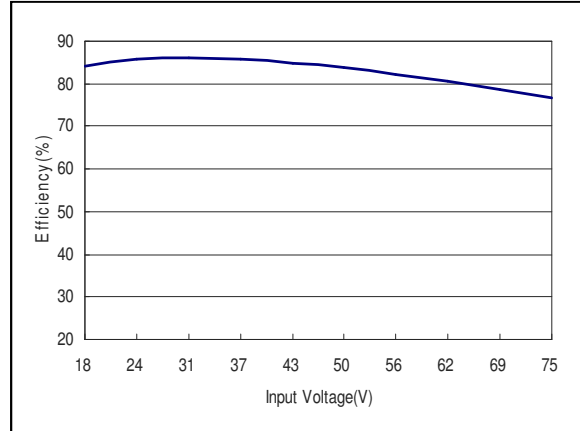

Figure 92: ATA00B36-L Efficiency Versus Input Voltage Curve
Vin = 18 to 75Vdc, Load: Io = 0.25A, Ta = 25 °C

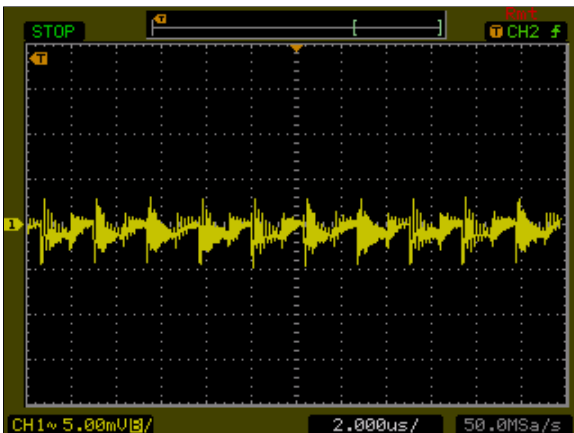

Figure 93: ATA00B36-L Ripple and Noise Measurement
Vin = 48Vdc, Load: Io = 0.25A, Ta = 25 °C
Ch 1: Vo

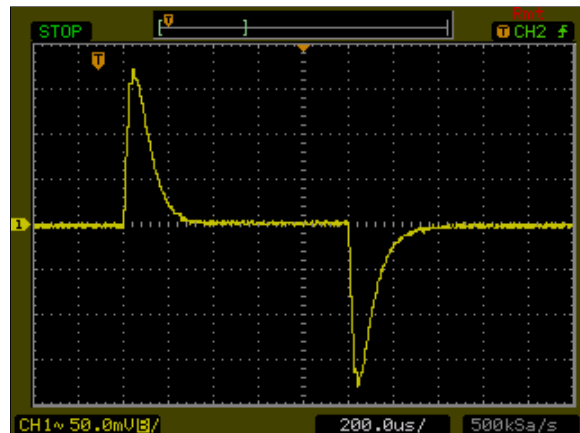

Figure 94: ATA00B36-L Transient Response
Vin = 48Vdc, Load: Io = 100% to 75% load change, Ta = 25 °C
Ch 1: Vo

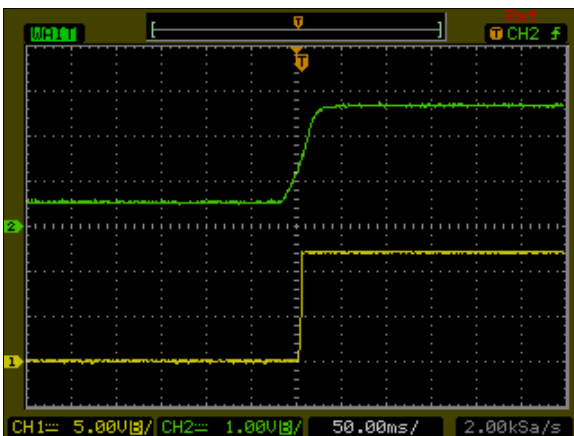

Figure 95: ATA00B36-L Output Voltage Startup Characteristic by Remote
Vin = 48Vdc, Load: Io = 0.25A, Ta = 25 °C
Ch1: Vo
Ch2: Remote On/Off

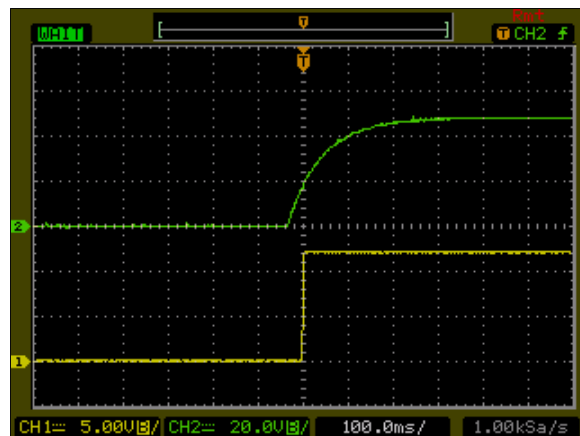

Figure 96: ATA00B36-L Output Voltage Startup Characteristic by Vin
Vin = 48Vdc, Load: Io = 0.25A, Ta = 25 °C
Ch1: Vo
Ch2: Vin

ATA00B36-L Performance Curves

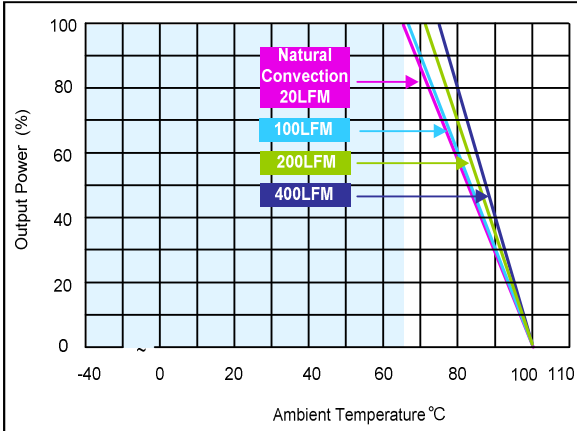

Figure 97: ATA00B36-L Derating Curves
Vin = 48Vdc, Load: Io = 0 to 0.25A, Ta = 25 °C

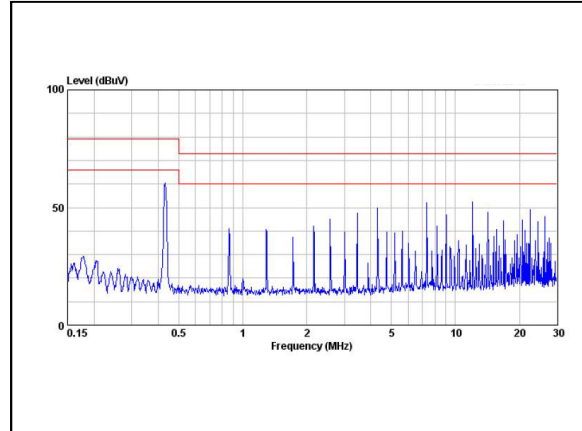

Figure 98: ATA00B36-L Conduction Emission of EN550122 Class A
Vin = 48Vdc, Load: Io = 0.25A, Ta = 25 °C

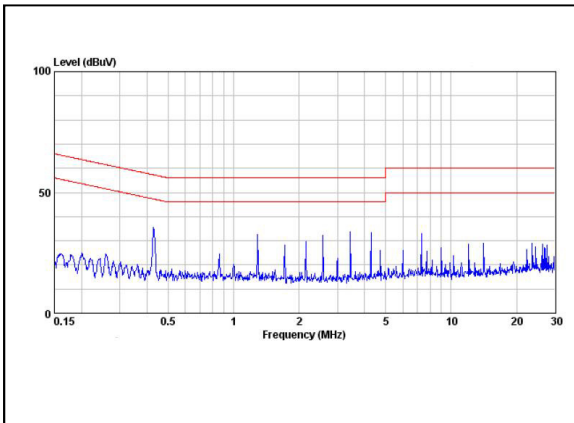

Figure 99: ATA00B36-L Conduction Emission of EN550122 Class B
Vin = 48Vdc, Load: Io = 0.25A, Ta = 25 °C (with external filter)

ATA00C36-L Performance Curves

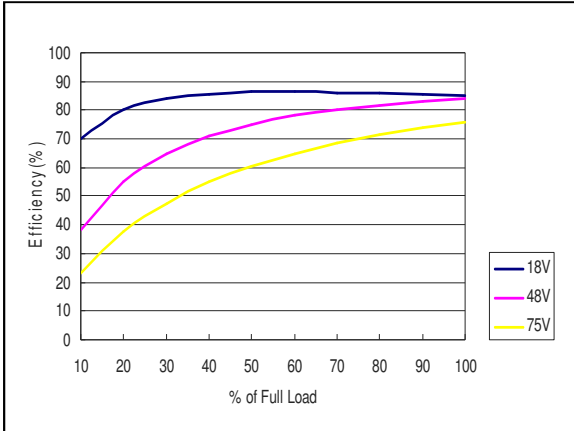

Figure 100: ATA00C36-L Efficiency Versus Output Current Curve
Vin = 18 to 75Vdc, Load: Io = 0 to 0.2A, Ta = 25 °C

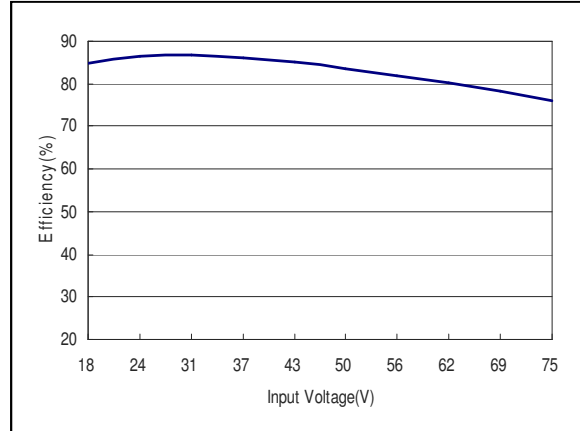

Figure 101: ATA00C36-L Efficiency Versus Input Voltage Curve
Vin = 18 to 75Vdc, Load: Io = 0.2A, Ta = 25 °C

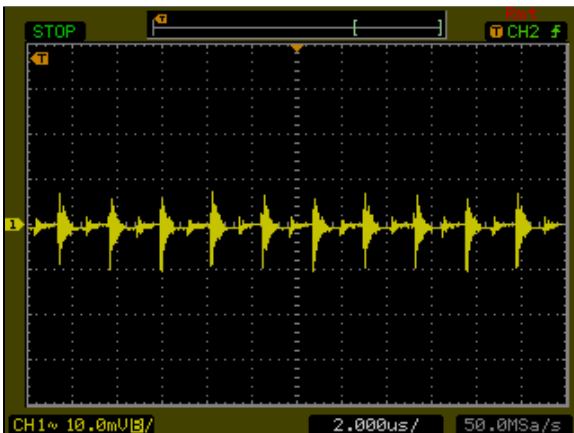

Figure 102: ATA00C36-L Ripple and Noise Measurement
Vin = 48Vdc, Load: Io = 0.2A, Ta = 25 °C
Ch 1: Vo

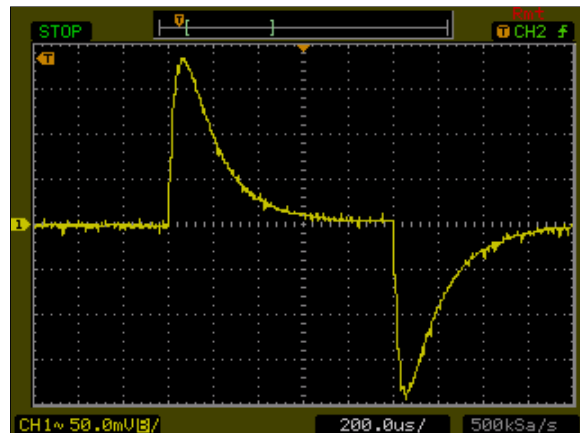

Figure 103: ATA00C36-L Transient Response
Vin = 48Vdc, Load: Io = 100% to 75% load change, Ta = 25 °C
Ch 1: Vo

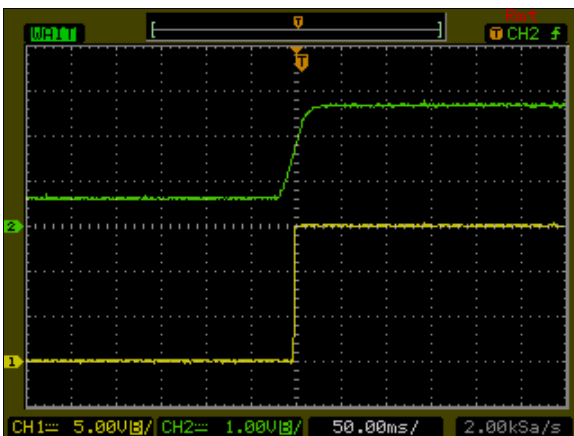

Figure 104: ATA00C36-L Output Voltage Startup Characteristic by Remote
Vin = 48Vdc, Load: Io = 0.2A, Ta = 25 °C
Ch1: Vo Ch2: Remote On/Off

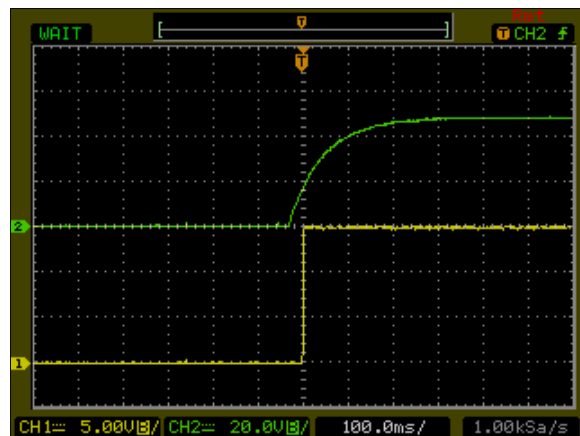

Figure 105: ATA00C36-L Output Voltage Startup Characteristic by Vin
Vin = 48Vdc, Load: Io = 0.2A, Ta = 25 °C
Ch1: Vo Ch2: Vin

ATA00C36-L Performance Curves

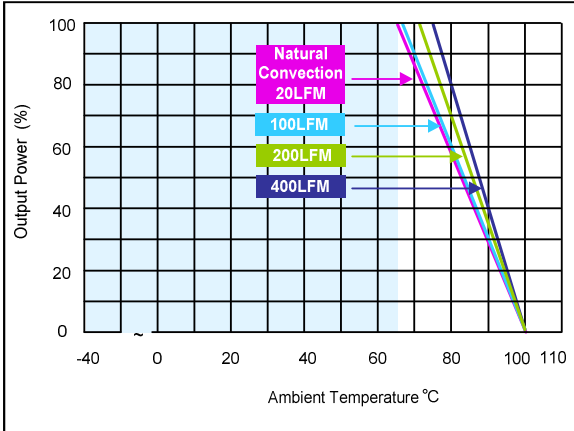

Figure 106: ATA00C36-L Derating Curves
Vin = 48Vdc, Load: Io = 0 to 0.2A, Ta = 25 °C

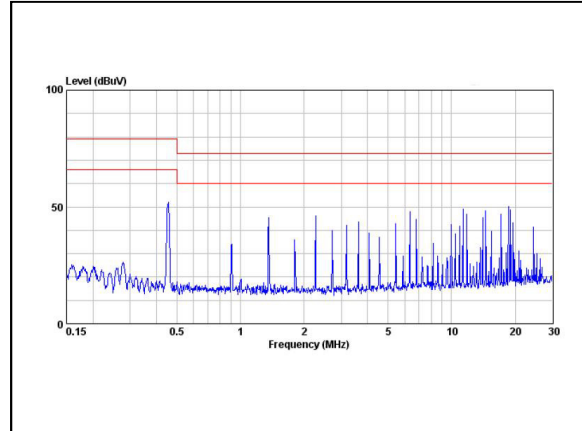

Figure 107: ATA00C36-L Conduction Emission of EN550122 Class A
Vin = 48Vdc, Load: Io = 0.2A, Ta = 25 °C

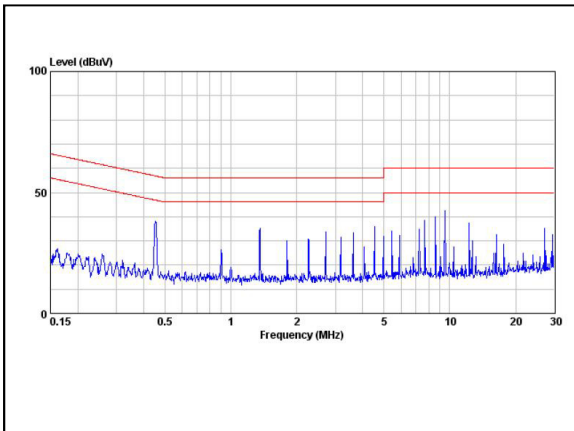

Figure 108: ATA00C36-L Conduction Emission of EN550122 Class B
Vin = 48Vdc, Load: Io = 0.2A, Ta = 25 °C (with external filter)

ATA00H36-L Performance Curves

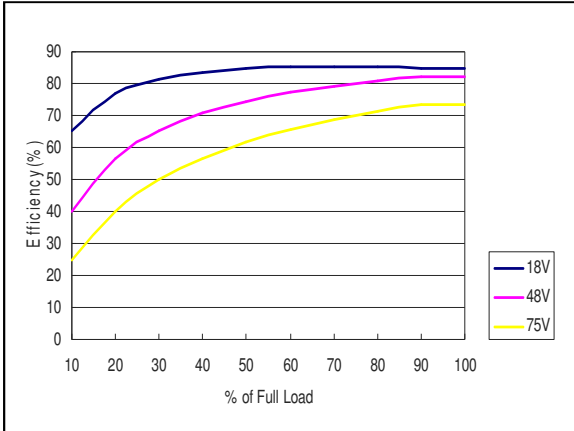

Figure 109: ATA00H36-L Efficiency Versus Output Current Curve
Vin = 18 to 75Vdc, Load: Io = 0 to 0.125A, Ta = 25 °C

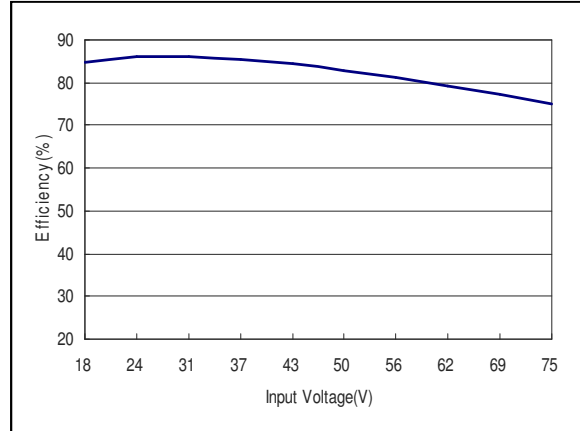

Figure 110: ATA00H36-L Efficiency Versus Input Voltage Curve
Vin = 18 to 75Vdc, Load: Io = 0.125A, Ta = 25 °C

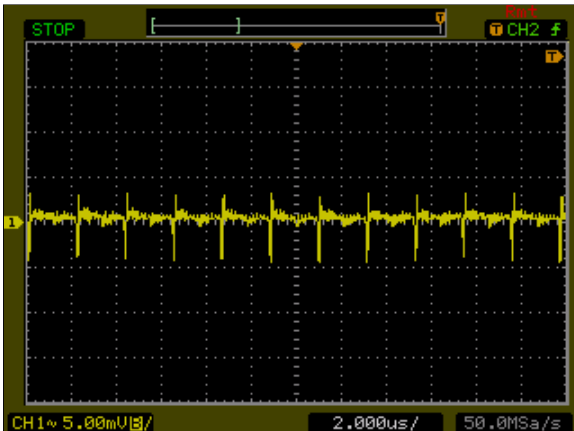

Figure 111: ATA00H36-L Ripple and Noise Measurement
Vin = 48Vdc, Load: Io = 0.125A, Ta = 25 °C
Ch 1: Vo

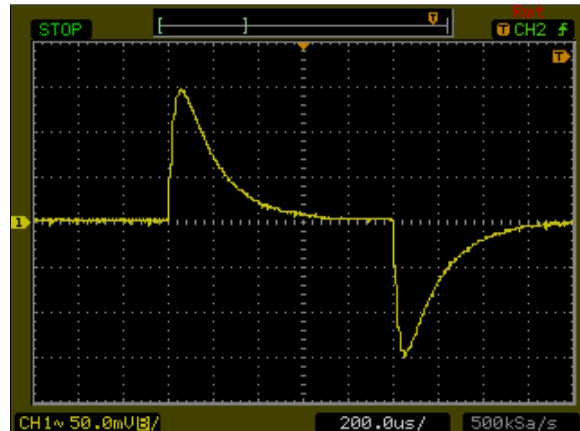

Figure 112: ATA00H36-L Transient Response
Vin = 48Vdc, Load: Io = 100% to 75% load change, Ta = 25 °C
Ch 1: Vo

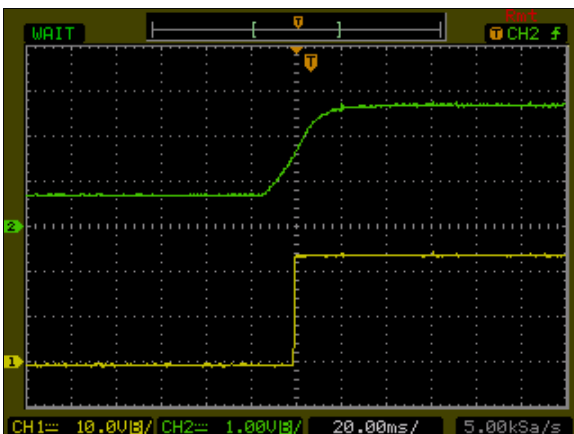

Figure 113: ATA00H36-L Output Voltage Startup Characteristic by Remote
Vin = 48Vdc, Load: Io = 0.125A, Ta = 25 °C
Ch1: Vo
Ch2: Remote On/Off

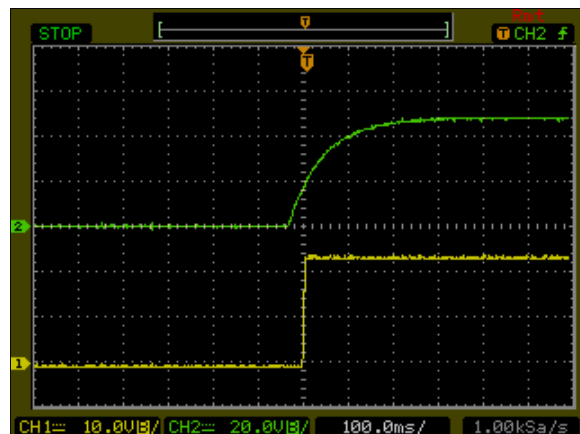

Figure 114: ATA00H36-L Output Voltage Startup Characteristic by Vin
Vin = 48Vdc, Load: Io = 0.125A, Ta = 25 °C
Ch1: Vo
Ch2: Vin

ATA00H36-L Performance Curves

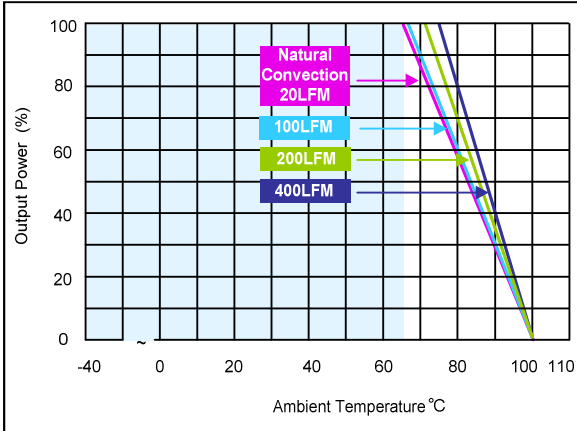

Figure 115: ATA00H36-L Derating Curves
Vin = 48Vdc, Load: Io = 0 to 0.125A, Ta = 25 °C

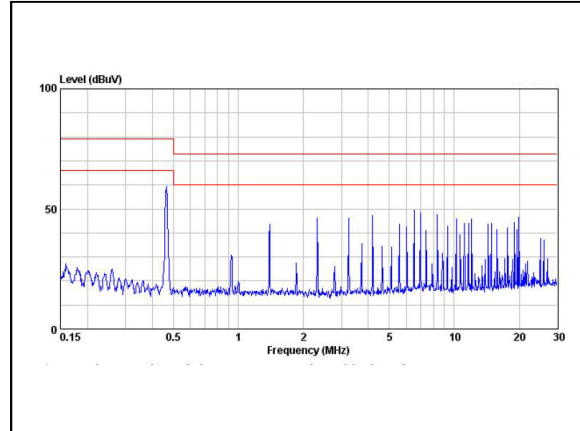

Figure 116: ATA00H36-L Conduction Emission of EN550122 Class A
Vin = 48Vdc, Load: Io = 0.125A, Ta = 25 °C

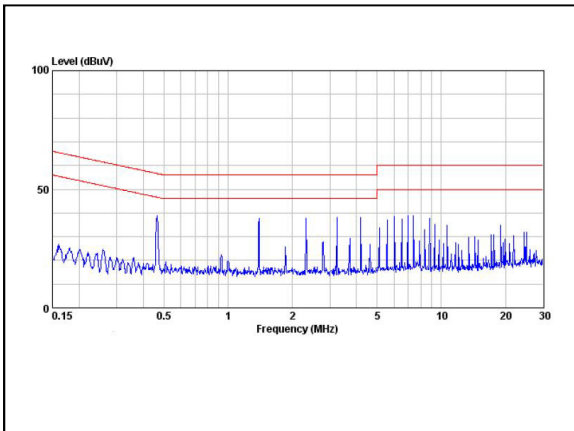

Figure 117: ATA00H36-L Conduction Emission of EN550122 Class B
Vin = 48Vdc, Load: Io = 0.125A, Ta = 25 °C (with external filter)

ATA00AA36-L Performance Curves

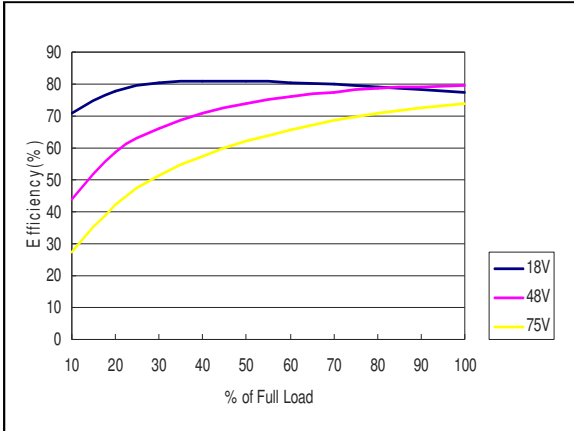

Figure 118: ATA00AA36-L Efficiency Versus Output Current Curve
Vin = 18 to 75Vdc, Load: Io = 0 to ±0.3A, Ta = 25 °C

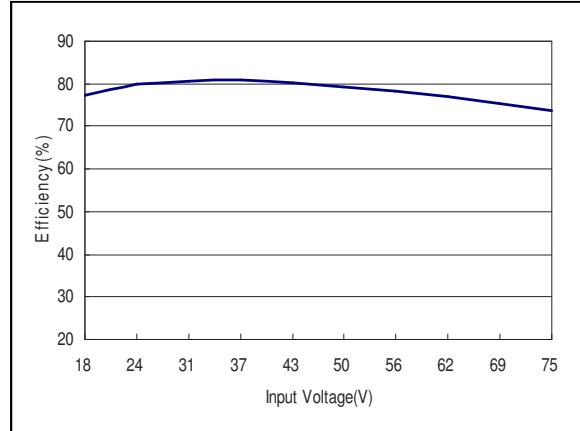

Figure 119: ATA00AA36-L Efficiency Versus Input Voltage Curve
Vin = 18 to 75Vdc, Load: Io = ±0.3A, Ta = 25 °C



Figure 120: ATA00AA36-L Ripple and Noise Measurement
Vin = 48Vdc, Load: Io = ±0.3A, Ta = 25 °C
Ch 1: V1
Ch 2: V2

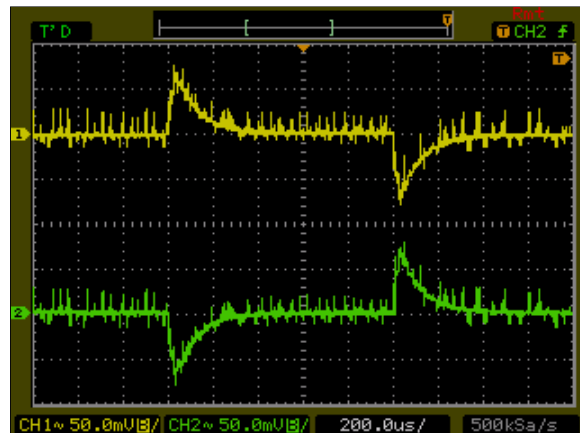

Figure 121: ATA00AA36-L Transient Response
Vin = 48Vdc, Load: Io = 100% to 75% load change, Ta=25 °C
Ch 1: V1
Ch 2: V2

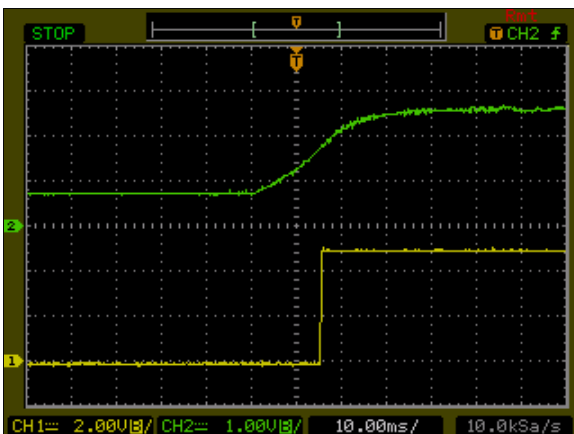

Figure 122: ATA00AA36-L Output Voltage Startup Characteristic by Remote
Vin = 48Vdc, Load: Io = ±0.3A, Ta = 25 °C
Ch1: V1
Ch2: Remote On/Off

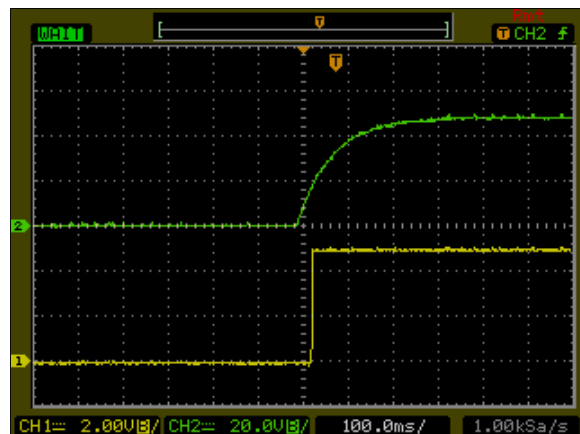

Figure 123: ATA00AA36-L Output Voltage Startup Characteristic by Vin
Vin = 48Vdc, Load: Io = ±0.3A, Ta = 25 °C
Ch1: V1
Ch2: Vin

ATA00AA36-L Performance Curves

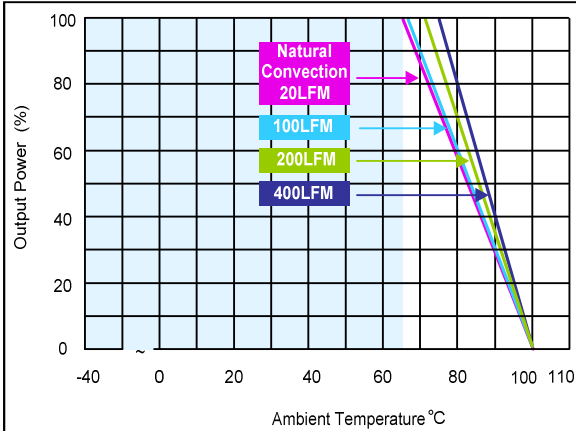

Figure 124: ATA00AA36-L Derating Curves
Vin = 48Vdc, Load: Io = 0 to ±0.3A, Ta = 25 °C

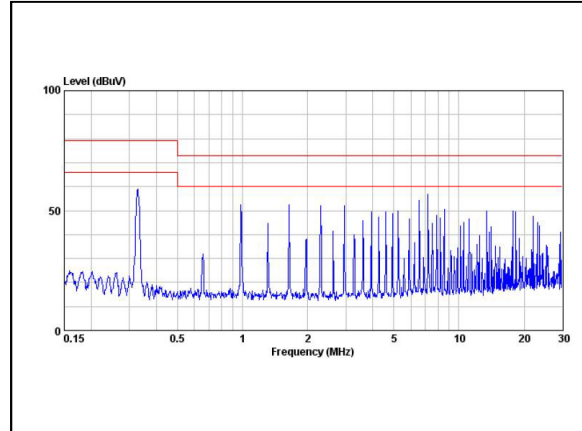

Figure 125: ATA00AA36-L Conduction Emission of EN550122 Class A
Vin = 48Vdc, Load: Io = ±0.3A, Ta = 25 °C

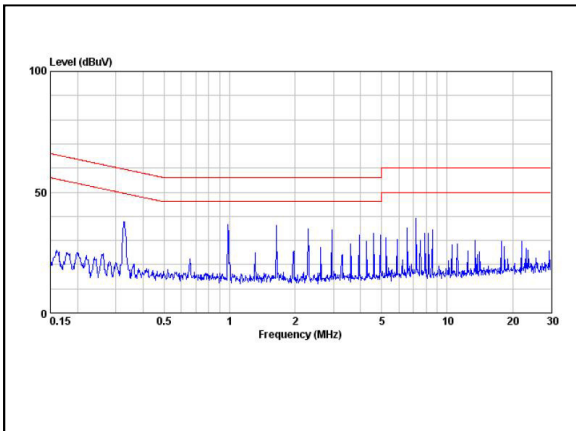

Figure 126: ATA00AA36-L Conduction Emission of EN550122 Class B
Vin = 48Vdc, Load: Io = ±0.3A, Ta = 25 °C (with external filter)

ATA00BB36-L Performance Curves

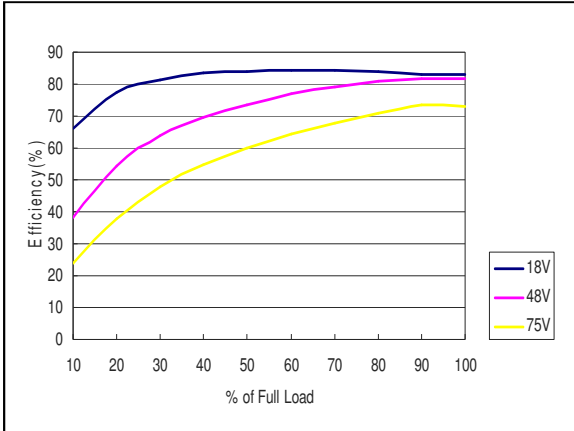

Figure 127: ATA00BB36-L Efficiency Versus Output Current Curve
Vin = 18 to 75Vdc, Load: Io = 0 to ±0.125A, Ta = 25 °C

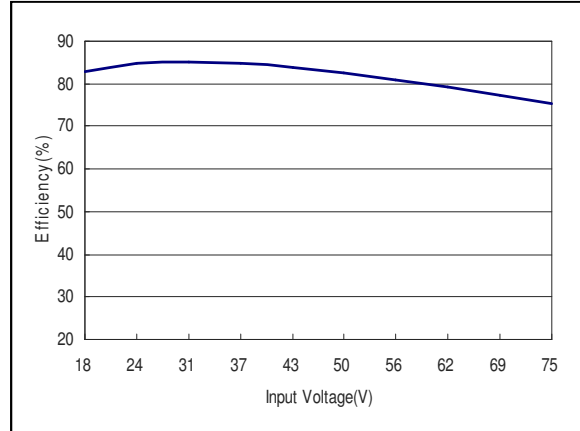

Figure 128: ATA00BB36-L Efficiency Versus Input Voltage Curve
Vin = 18 to 75Vdc, Load: Io = ±0.125A, Ta = 25 °C



Figure 129: ATA00BB36-L Ripple and Noise Measurement
Vin = 48Vdc, Load: Io = ±0.125A, Ta = 25 °C
Ch 1: V1
Ch 2: V2

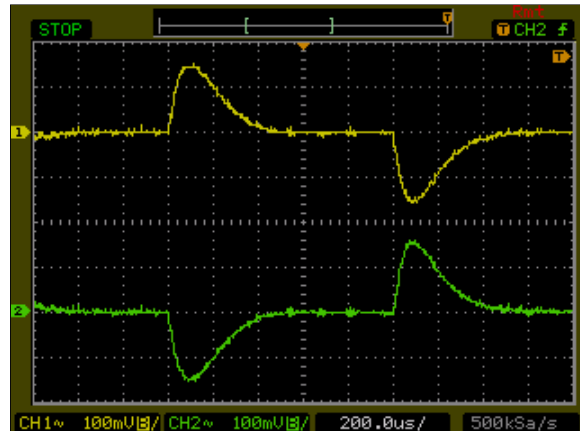

Figure 130: ATA00BB36-L Transient Response
Vin = 48Vdc, Load: Io = 100% to 75% load change, Ta = 25 °C
Ch 1: V1
Ch 2: V2

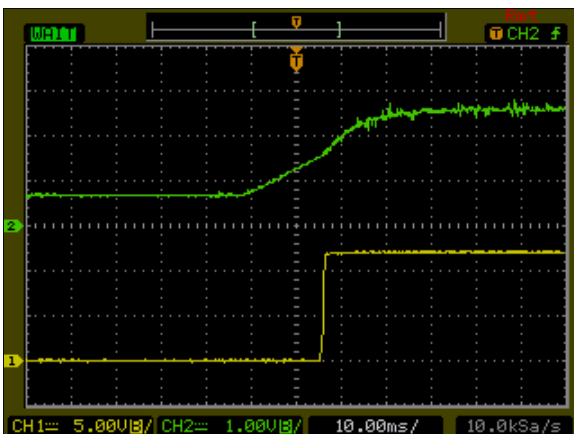

Figure 131: ATA00BB36-L Output Voltage Startup Characteristic by Remote
Vin = 48Vdc, Load: Io = ±0.125A, Ta = 25 °C
Ch1: V1
Ch2: Remote On/Off

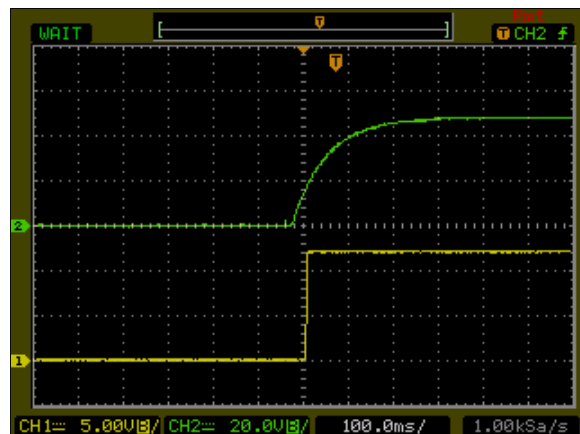

Figure 132: ATA00BB36-L Output Voltage Startup Characteristic by Vin
Vin = 48Vdc, Load: Io = ±0.125A, Ta = 25 °C
Ch1: V1
Ch2: Vin

ATA00BB36-L Performance Curves

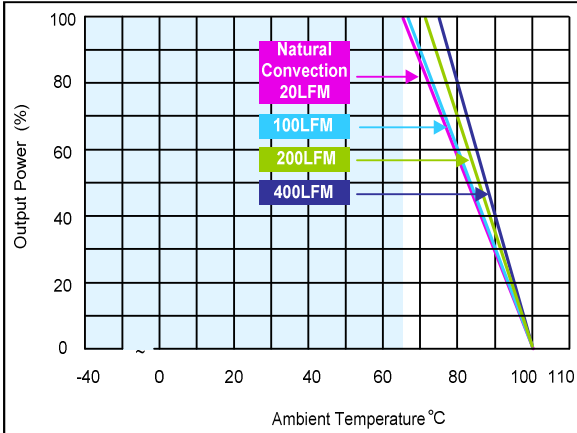

Figure 133: ATA00BB36-L Derating Curves
Vin = 48Vdc, Load: Io = 0 to ±0.125A, Ta = 25 °C

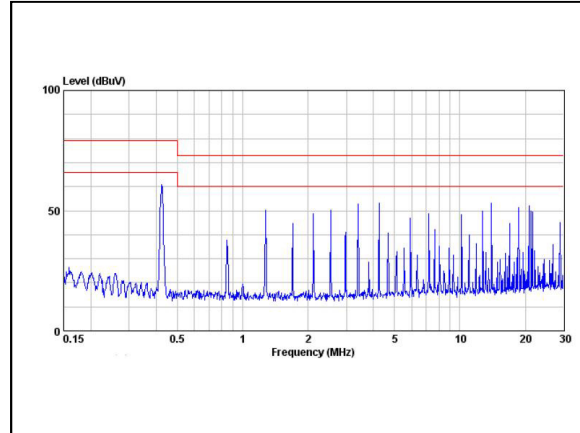

Figure 134: ATA00BB36-L Conduction Emission of EN550122 Class A
Vin = 48Vdc, Load: Io = ±0.125A, Ta = 25 °C

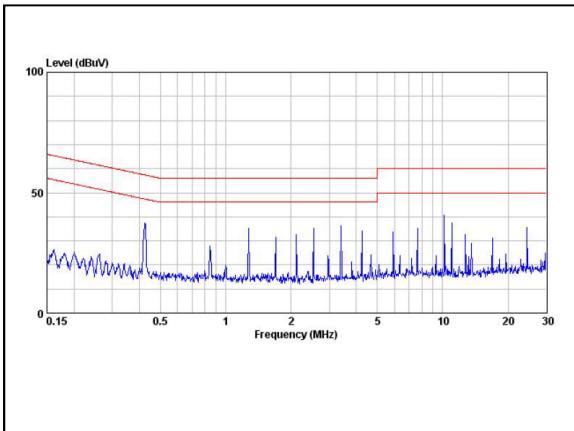

Figure 135: ATA00BB36-L Conduction Emission of EN550122 Class B
Vin = 48Vdc, Load: Io = ±0.125A, Ta = 25 °C (with external filter)

ATA00CC36-L Performance Curves

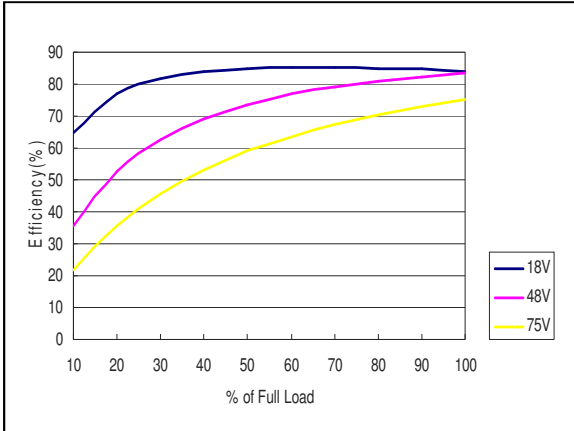

Figure 136: ATA00CC36-L Efficiency Versus Output Current Curve
Vin = 18 to 75Vdc, Load: Io = 0 to ±0.1A, Ta = 25 °C

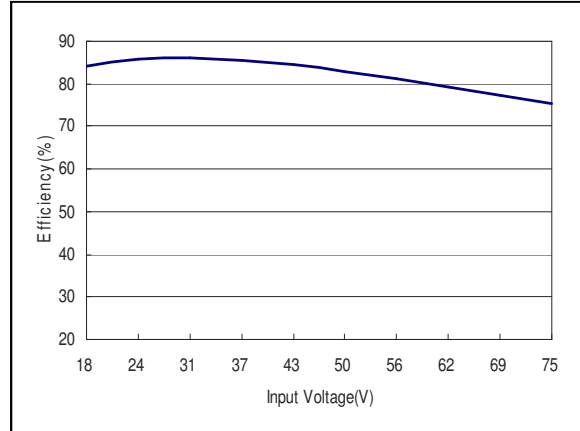

Figure 137: ATA00CC36-L Efficiency Versus Input Voltage Curve
Vin = 18 to 75Vdc, Load: Io = ±0.1A, Ta = 25 °C

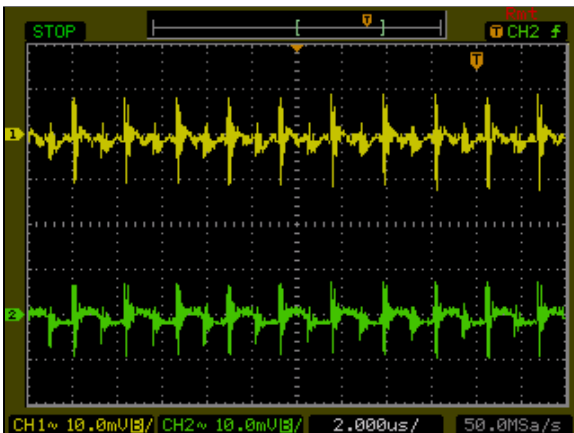

Figure 138: ATA00CC36-L Ripple and Noise Measurement
Vin = 48Vdc, Load: Io = ±0.1A, Ta = 25 °C
Ch 1: V1
Ch 2: V2



Figure 139: ATA00CC36-L Transient Response
Vin = 48Vdc, Load: Io = 100% to 75% load change, Ta=25 °C
Ch 1: V1
Ch 2: V2

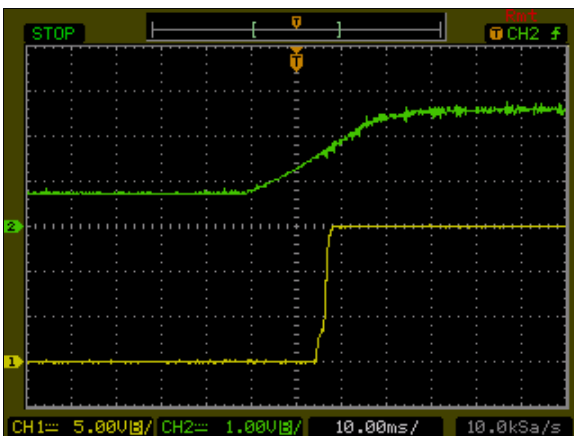

Figure 140: ATA00CC36-L Output Voltage Startup Characteristic by Remote
Vin = 48Vdc, Load: Io = ±0.1A, Ta = 25 °C
Ch1: V1
Ch2: Remote On/Off

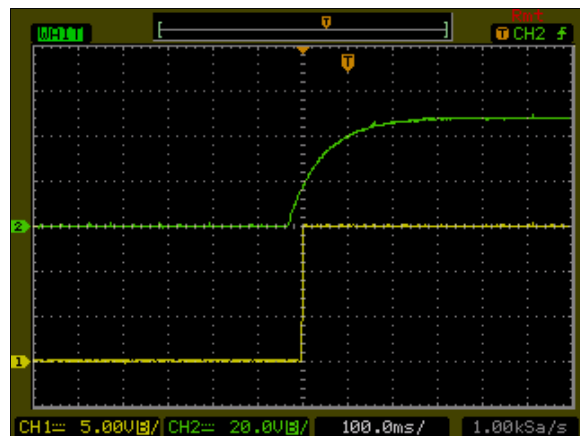

Figure 141: ATA00CC36-L Output Voltage Startup Characteristic by Vin
Vin = 48Vdc, Load: Io = ±0.1A, Ta = 25 °C
Ch1: V1
Ch2: Vin

ATA00CC36-L Performance Curves

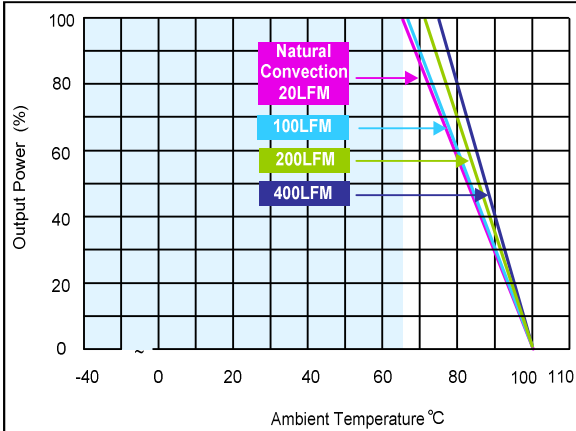

Figure 142: ATA00CC36-L Derating Curves
Vin = 48Vdc, Load: Io = 0 to ±0.1A, Ta = 25 °C

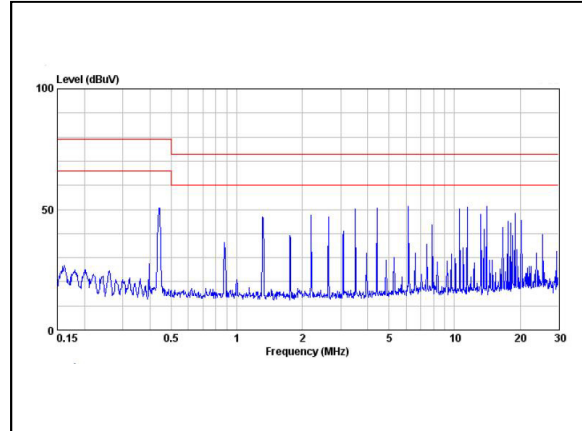

Figure 143: ATA00CC36-L Conduction Emission of EN550122 Class A
Vin = 48Vdc, Load: Io = ±0.1A, Ta = 25 °C

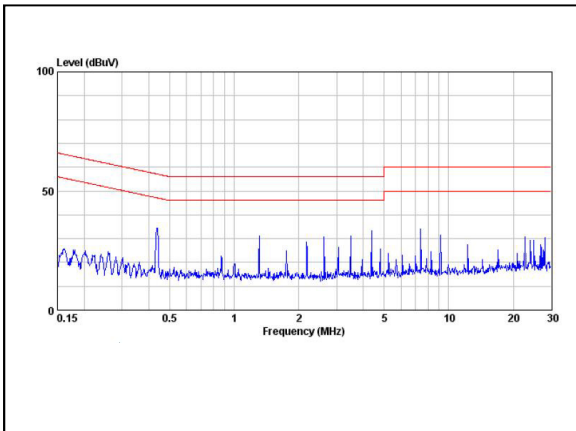

Figure 144: ATA00CC36-L Conduction Emission of EN550122 Class B
Vin = 48Vdc, Load: Io = ±0.1A, Ta = 25 °C (with external filter)

ATA00F18S-L Performance Curves

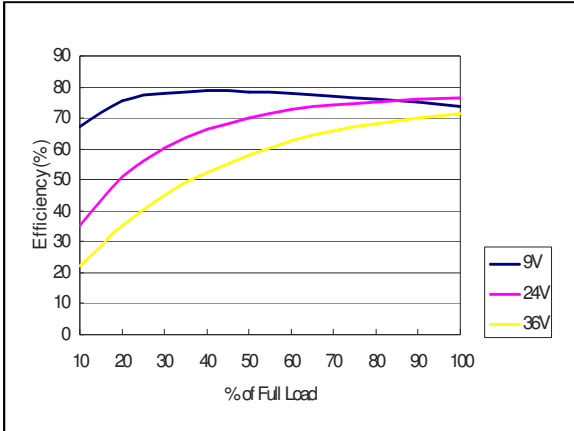

Figure 145: ATA00F18S-L Efficiency Versus Output Current Curve
Vin = 9 to 36Vdc, Load: Io = 0 to 0.6A, Ta = 25 °C

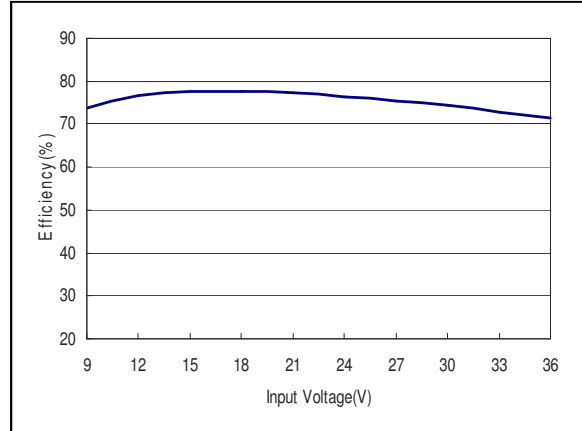

Figure 146: ATA00F18S-L Efficiency Versus Input Voltage Curve
Vin = 9 to 36Vdc, Load: Io = 0.6A, Ta = 25 °C

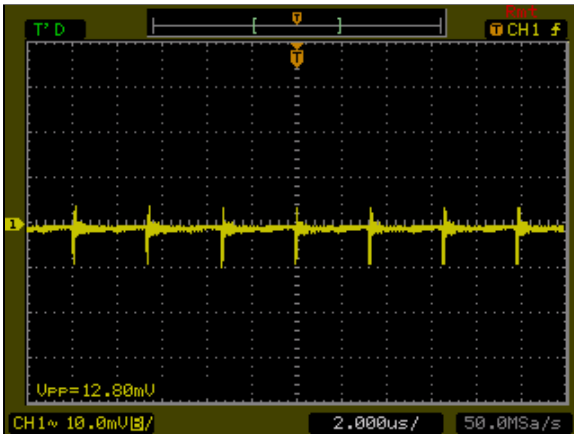

Figure 147: ATA00F18S-L Ripple and Noise Measurement
Vin = 24Vdc, Load: Io = 0.6A, Ta = 25 °C
Ch 1: Vo

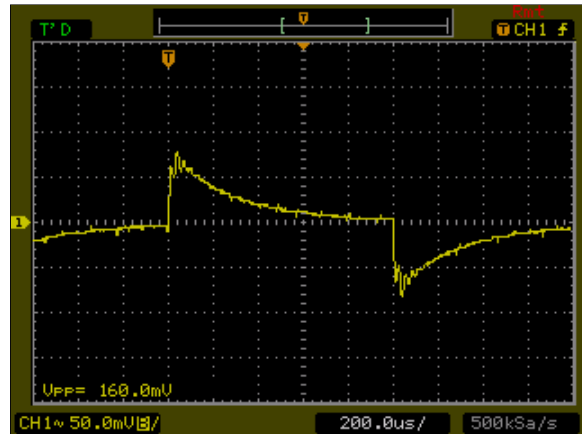

Figure 148: ATA00F18S-L Transient Response
Vin = 24Vdc, Load: Io = 100% to 75% load change, Ta = 25 °C
Ch 1: Vo

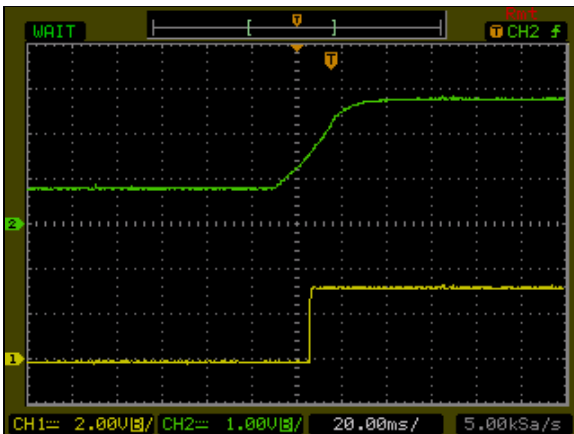

Figure 149: ATA00F18S-L Output Voltage Startup Characteristic by Remote
Vin = 24Vdc, Load: Io = 0.6A, Ta = 25 °C
Ch1: Vo
Ch2: Remote On/Off

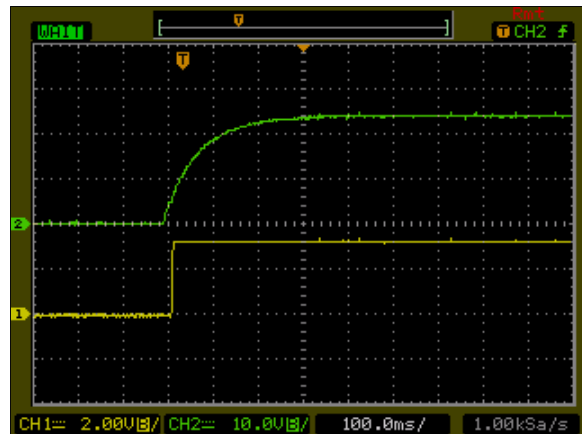

Figure 150: ATA00F18S-L Output Voltage Startup Characteristic by Vin
Vin = 24Vdc, Load: Io = 0.6A, Ta = 25 °C
Ch1: Vo
Ch2: Vin

ATA00F18S-L Performance Curves

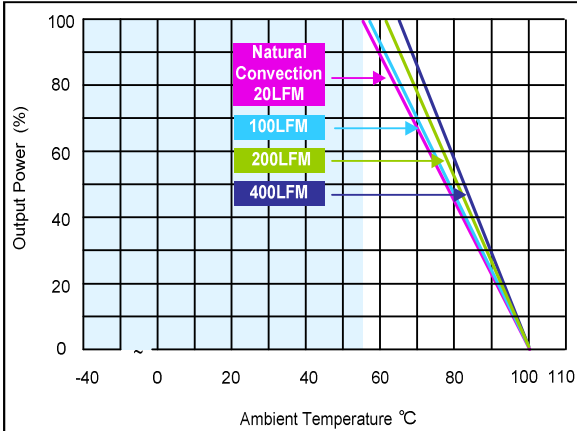

Figure 151: ATA00F18S-L Derating Curves
Vin = 24Vdc, Load: Io = 0 to 0.6A, Ta = 25 °C

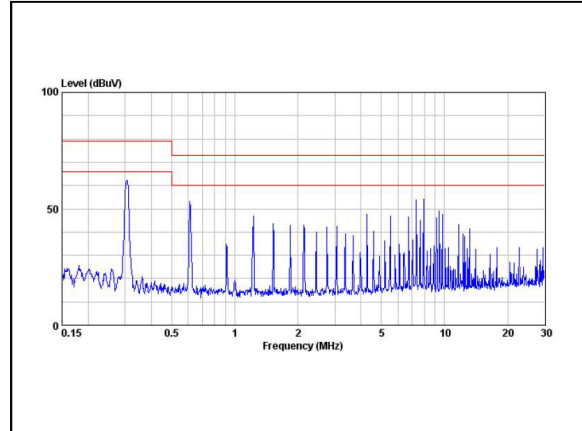

Figure 152: ATA00F18S-L Conduction Emission of EN550122 Class A
Vin = 24Vdc, Load: Io = 0.6A, Ta = 25 °C

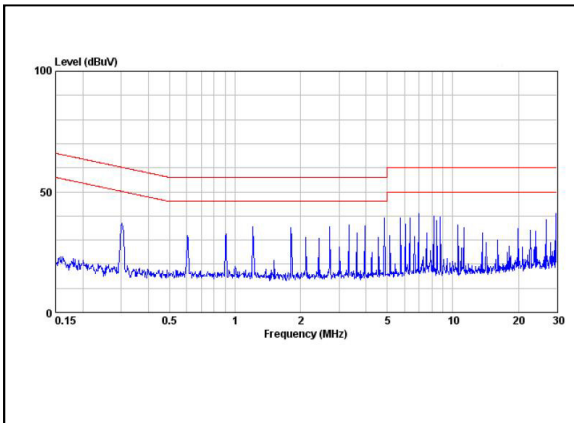

Figure 153: ATA00F18S-L Conduction Emission of EN550122 Class B
Vin = 24Vdc, Load: Io = 0.6A, Ta = 25 °C (with external filter)

ATA00A18S-L Performance Curves

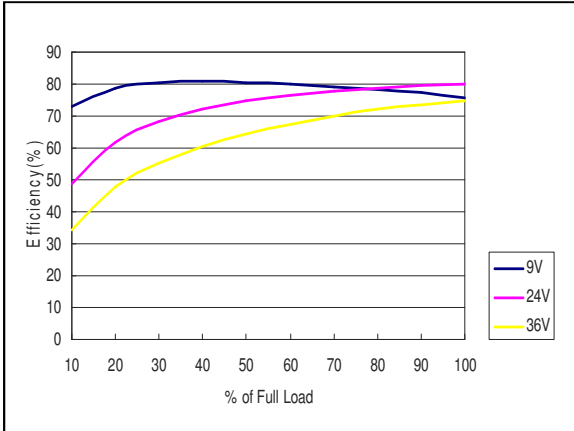

Figure 154: ATA00A18S-L Efficiency Versus Output Current Curve
Vin = 9 to 36Vdc, Load: Io = 0 to 0.6A, Ta = 25 °C

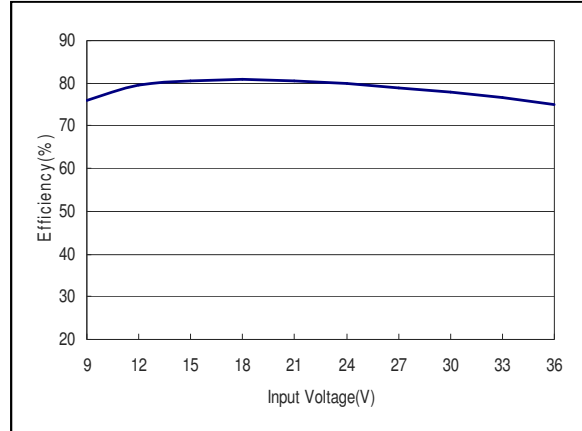

Figure 155: ATA00A18S-L Efficiency Versus Input Voltage Curve
Vin = 9 to 36Vdc, Load: Io = 0.6A, Ta = 25 °C

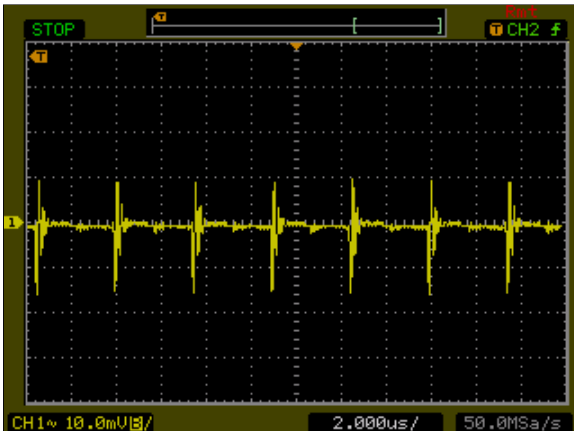

Figure 156: ATA00A18S-L Ripple and Noise Measurement
Vin = 24Vdc, Load: Io = 0.6A, Ta = 25 °C
Ch 1: Vo

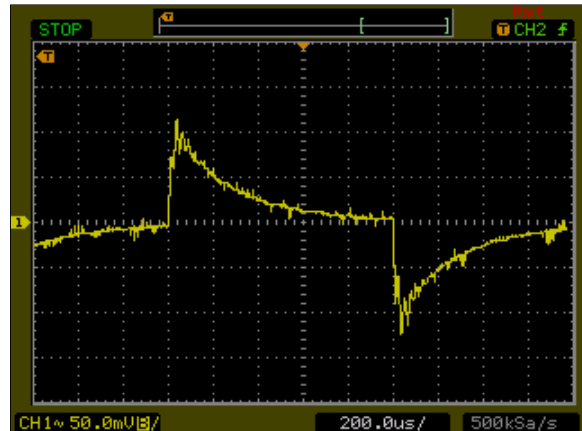

Figure 157: ATA00A18S-L Transient Response
Vin = 24Vdc, Load: Io = 100% to 75% load change, Ta = 25 °C
Ch 1: Vo

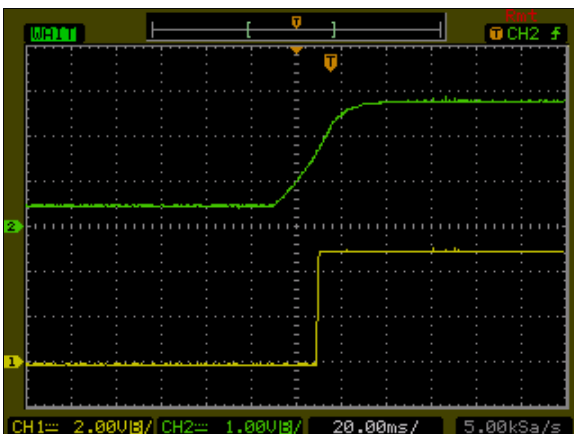

Figure 158: ATA00A18S-L Output Voltage Startup Characteristic by Remote
Vin = 24Vdc, Load: Io = 0.6A, Ta = 25 °C
Ch1: Vo
Ch2: Remote On/Off

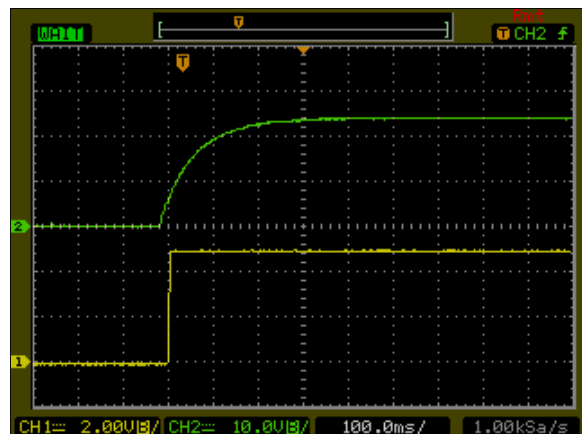

Figure 159: ATA00A18S-L Output Voltage Startup Characteristic by Vin
Vin = 24Vdc, Load: Io = 0.6A, Ta = 25 °C
Ch1: Vo
Ch2: Vin

ATA00A18S-L Performance Curves

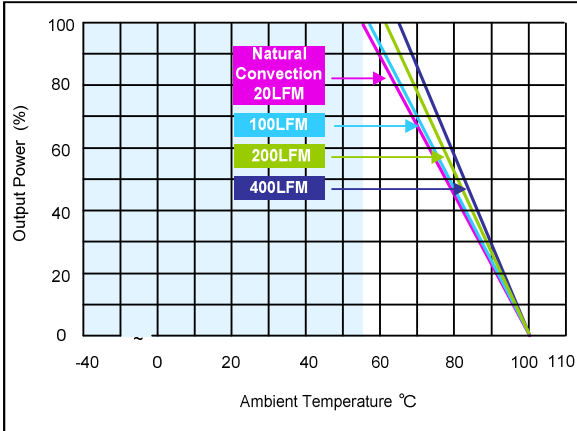

Figure 160: ATA00A18S-L Derating Curves
Vin = 24Vdc, Load: Io = 0 to 0.6A, Ta = 25 °C

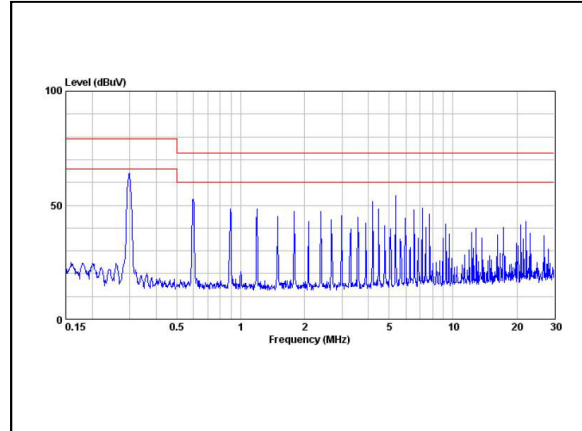

Figure 161: ATA00A18S-L Conduction Emission of EN550122 Class A
Vin = 24Vdc, Load: Io = 0.6A, Ta = 25 °C

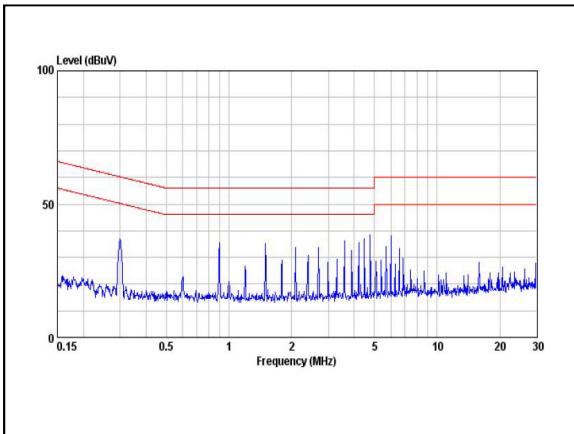

Figure 162: ATA00A18S-L Conduction Emission of EN550122 Class B
Vin = 24Vdc, Load: Io = 0.6A, Ta = 25 °C (with external filter)

ATA00B18S-L Performance Curves

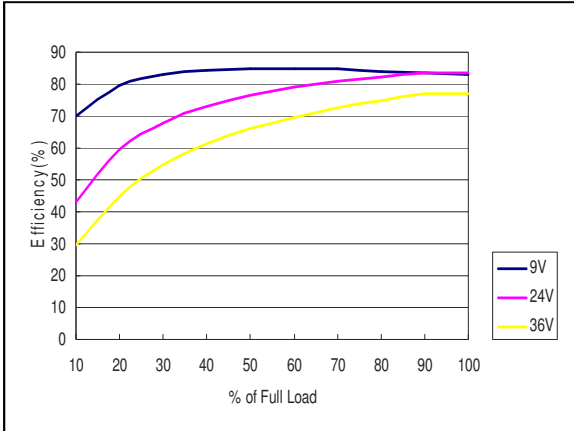

Figure 163: ATA00B18S-L Efficiency Versus Output Current Curve
Vin = 9 to 36Vdc, Load: Io = 0 to 0.25A, Ta = 25 °C

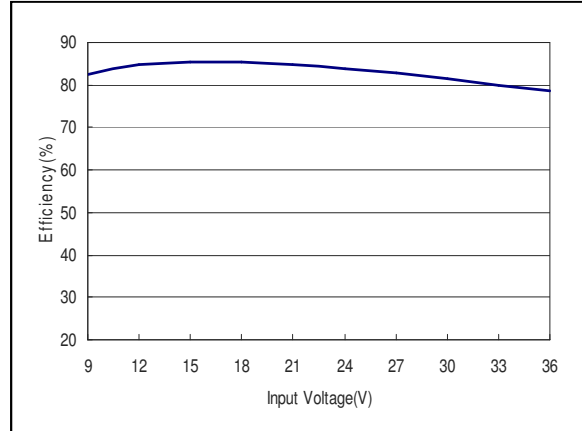

Figure 164: ATA00B18S-L Efficiency Versus Input Voltage Curve
Vin = 9 to 36Vdc, Load: Io = 0.25A, Ta = 25 °C

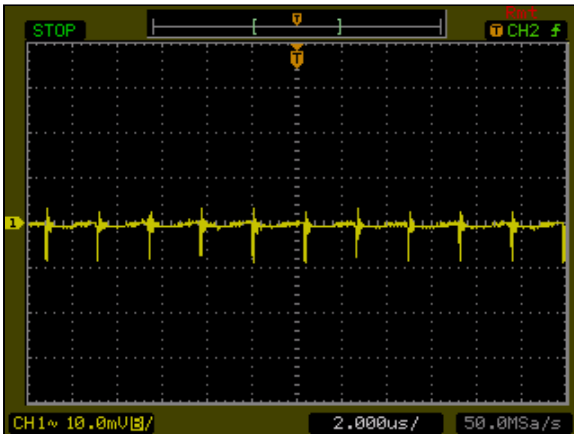

Figure 165: ATA00B18S-L Ripple and Noise Measurement
Vin = 24Vdc, Load: Io = 0.25A, Ta = 25 °C
Ch 1: Vo

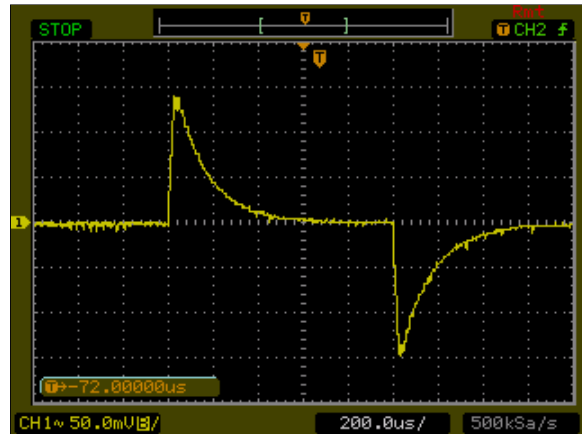

Figure 166: ATA00B18S-L Transient Response
Vin = 24Vdc, Load: Io = 100% to 75% load change, Ta = 25 °C
Ch 1: Vo

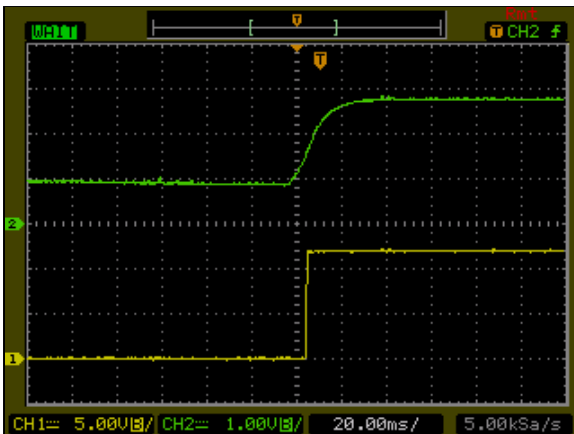

Figure 167: ATA00B18S-L Output Voltage Startup Characteristic by Remote
Vin = 24Vdc, Load: Io = 0.25A, Ta = 25 °C
Ch1: Vo
Ch2: Remote On/Off

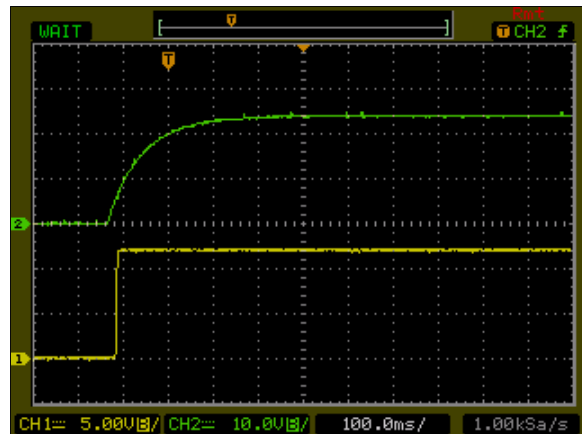

Figure 168: ATA00B18S-L Output Voltage Startup Characteristic by Vin
Vin = 24Vdc, Load: Io = 0.25A, Ta = 25 °C
Ch1: Vo
Ch2: Vin

ATA00B18S-L Performance Curves

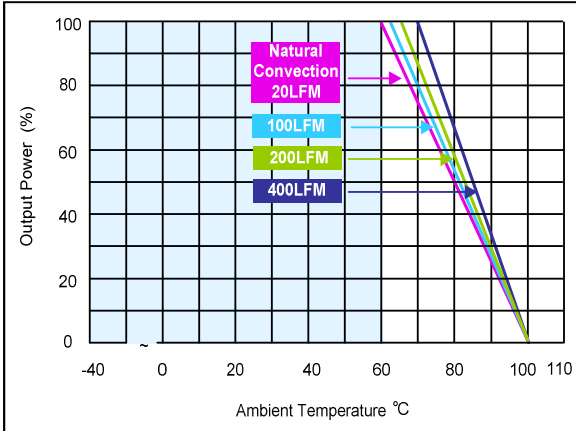

Figure 169: ATA00B18S-L Derating Curves
Vin = 24Vdc, Load: Io = 0 to 0.25A, Ta = 25 °C

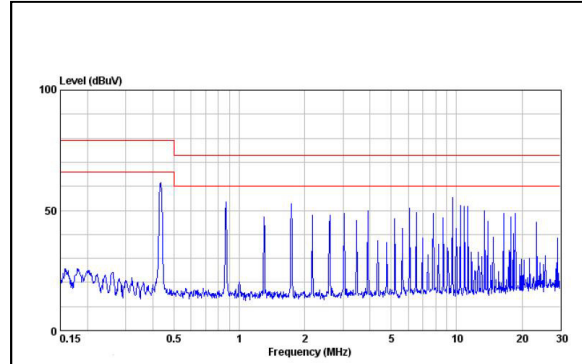

Figure 170: ATA00B18S-L Conduction Emission of EN550122 Class A
Vin = 24Vdc, Load: Io = 0.25A, Ta = 25 °C

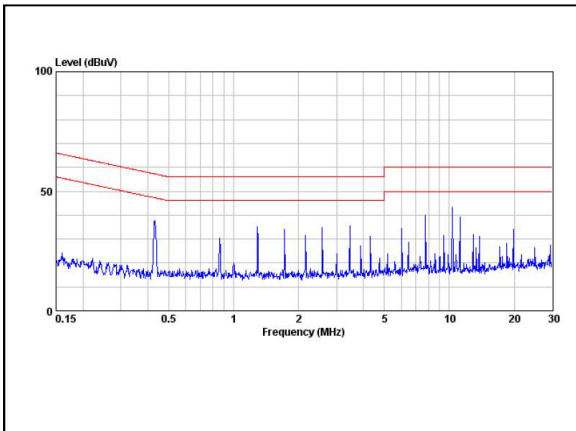

Figure 171: ATA00B18S-L Conduction Emission of EN550122 Class B
Vin = 24Vdc, Load: Io = 0.25A, Ta = 25 °C (with external filter)

ATA00C18S-L Performance Curves

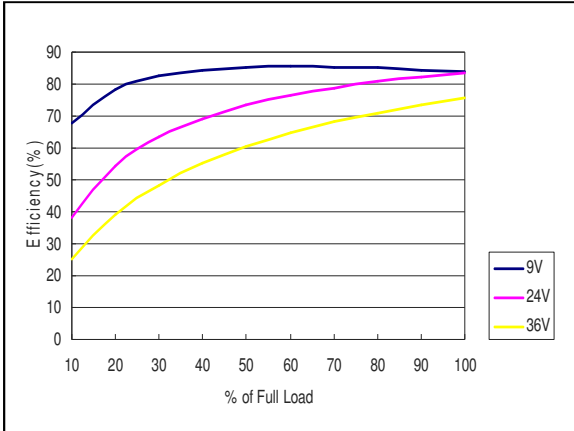

Figure 172: ATA00C18S-L Efficiency Versus Output Current Curve
Vin = 9 to 36Vdc, Load: Io = 0 to 0.2A, Ta = 25 °C

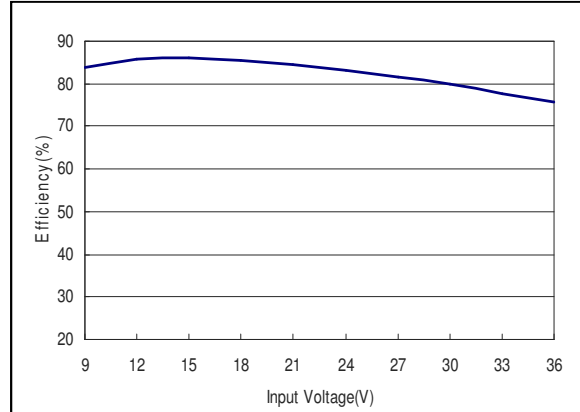

Figure 173: ATA00C18S-L Efficiency Versus Input Voltage Curve
Vin = 9 to 36Vdc, Load: Io = 0.2A, Ta = 25 °C

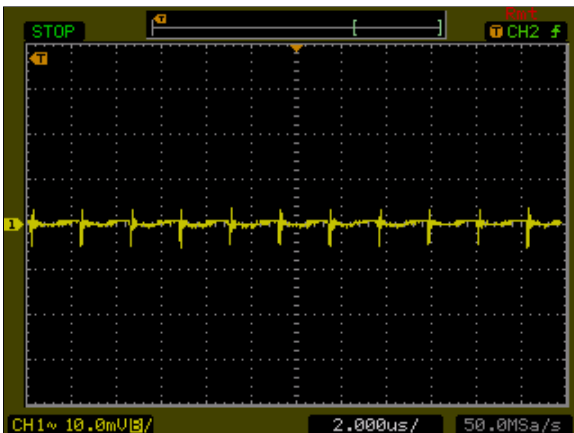

Figure 174: ATA00C18S-L Ripple and Noise Measurement
Vin = 24Vdc, Load: Io = 0.2A, Ta = 25 °C
Ch 1: Vo

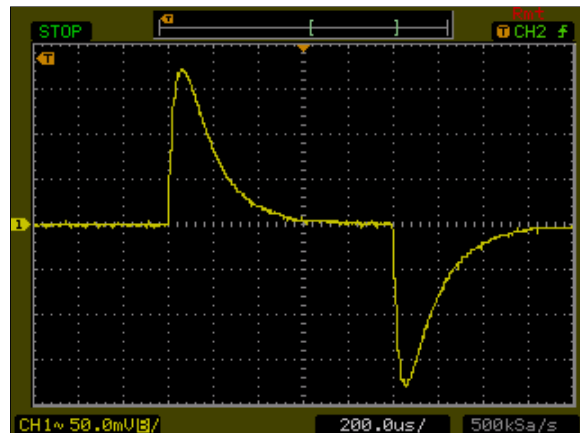

Figure 175: ATA00C18S-L Transient Response
Vin = 24Vdc, Load: Io = 100% to 75% load change, Ta = 25 °C
Ch 1: Vo

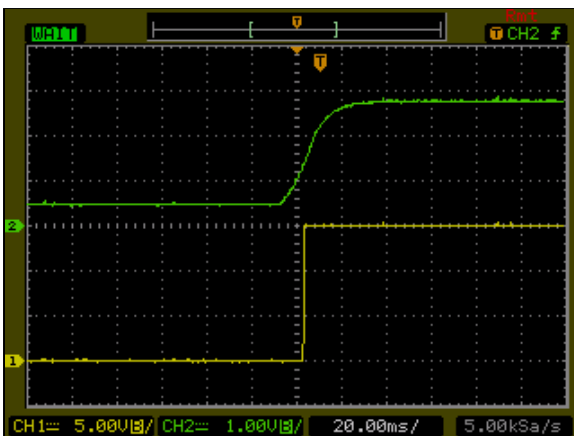

Figure 176: ATA00C18S-L Output Voltage Startup Characteristic by Remote
Vin = 24Vdc, Load: Io = 0.2A, Ta = 25 °C
Ch1: Vo
Ch2: Remote On/Off

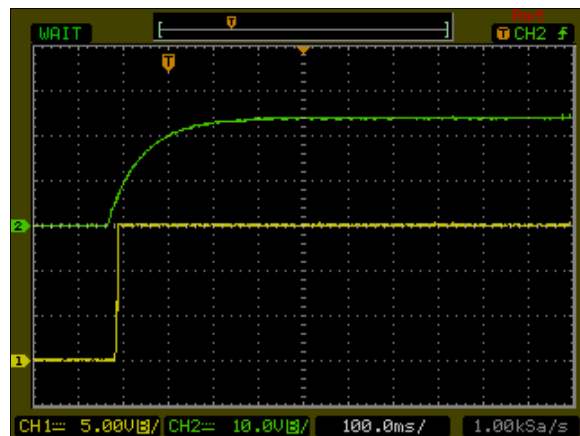

Figure 177: ATA00C18S-L Output Voltage Startup Characteristic by Vin
Vin = 24Vdc, Load: Io = 0.2A, Ta = 25 °C
Ch1: Vo
Ch2: Vin

ATA00C18S-L Performance Curves

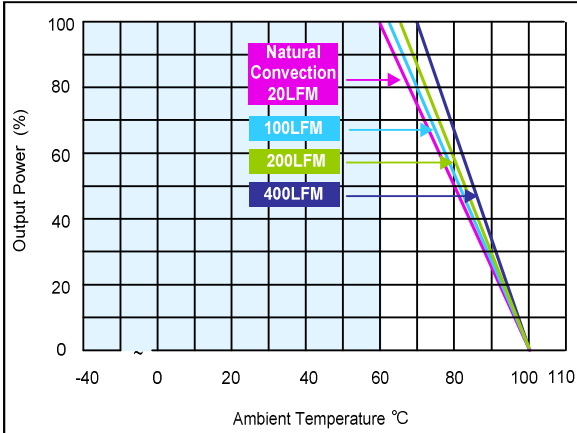

Figure 178: ATA00C18S-L Derating Curves
Vin = 24Vdc, Load: Io = 0 to 0.2A, Ta = 25 °C

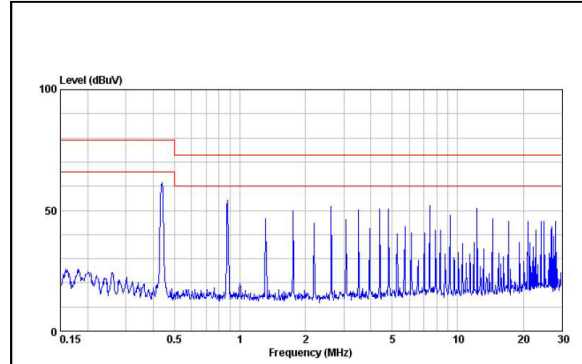

Figure 179: ATA00C18S-L Conduction Emission of EN550122 Class A
Vin = 24Vdc, Load: Io = 0.2A, Ta = 25 °C

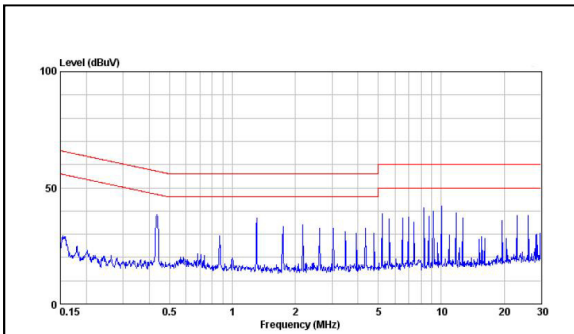

Figure 180: ATA00C18S-L Conduction Emission of EN550122 Class B
Vin = 24Vdc, Load: Io = 0.2A, Ta = 25 °C (with external filter)

ATA00H18S-L Performance Curves

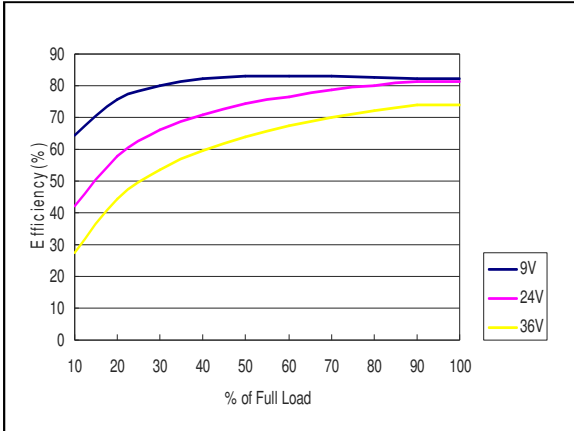

Figure 181: ATA00H18S-L Efficiency Versus Output Current Curve
Vin = 9 to 36Vdc, Load: Io = 0 to 0.125A, Ta = 25 °C

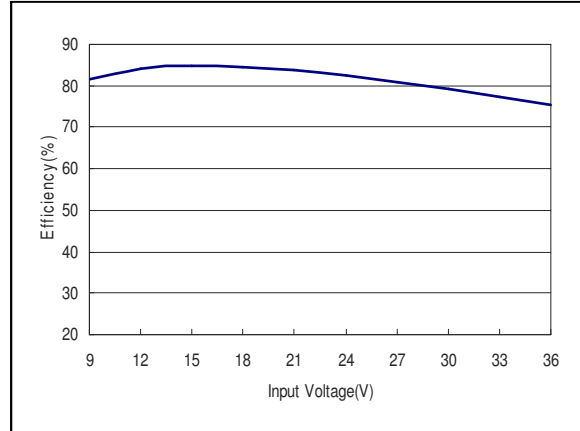

Figure 182: ATA00H18S-L Efficiency Versus Input Voltage Curve
Vin = 9 to 36Vdc, Load: Io = 0.125A, Ta = 25 °C

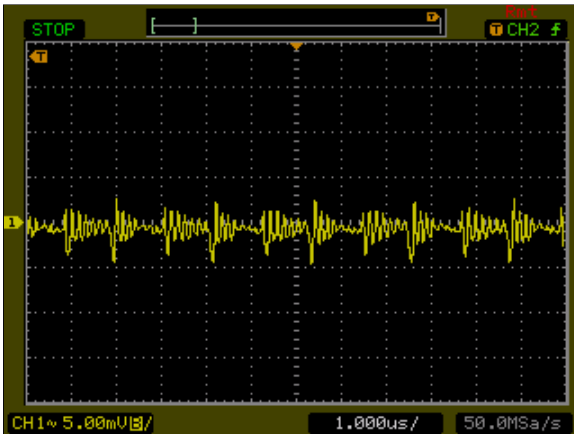

Figure 183: ATA00H18S-L Ripple and Noise Measurement
Vin = 24Vdc, Load: Io = 0.125A, Ta = 25 °C
Ch 1: Vo

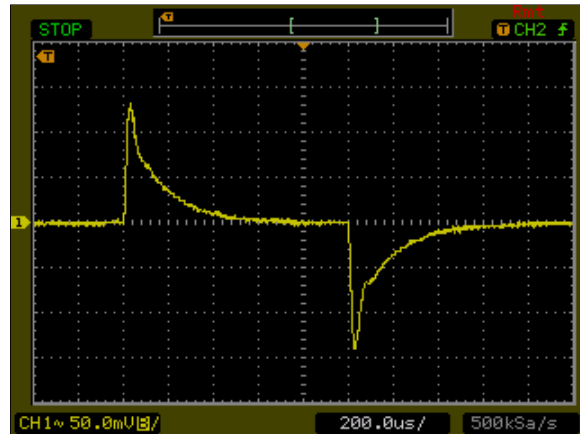

Figure 184: ATA00H18S-L Transient Response
Vin = 24Vdc, Load: Io = 100% to 75% load change, Ta = 25 °C
Ch 1: Vo

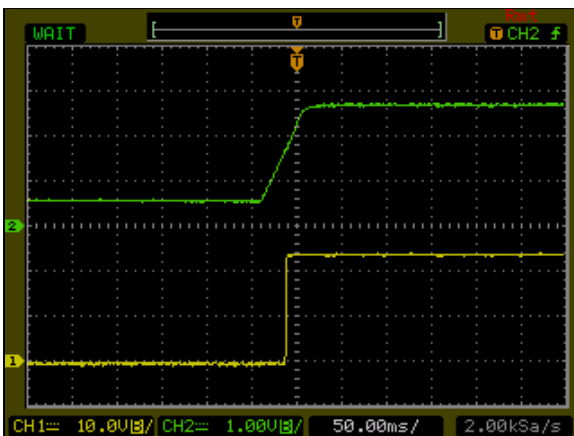

Figure 185: ATA00H18S-L Output Voltage Startup Characteristic by Remote
Vin = 24Vdc, Load: Io = 0.125A, Ta = 25 °C
Ch1: Vo
Ch2: Remote On/Off

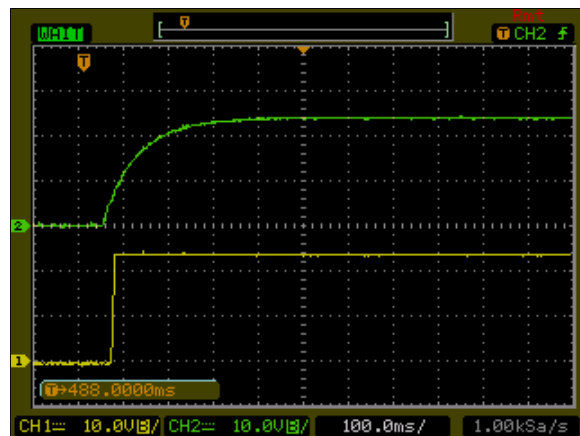

Figure 186: ATA00H18S-L Output Voltage Startup Characteristic by Vin
Vin = 24Vdc, Load: Io = 0.125A, Ta = 25 °C
Ch1: Vo
Ch2: Vin

ATA00H18S-L Performance Curves

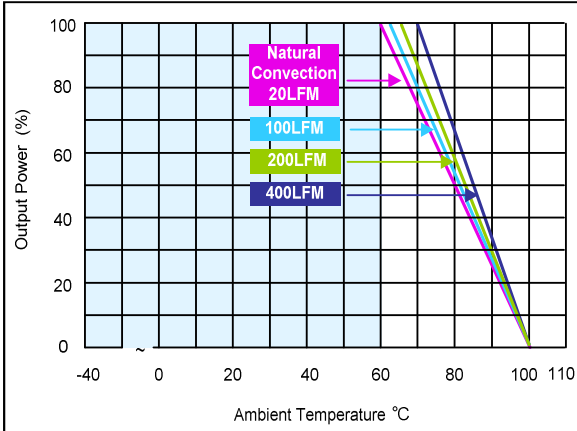

Figure 187: ATA00H18S-L Derating Curves
Vin = 24Vdc, Load: Io = 0 to 0.125A, Ta = 25 °C

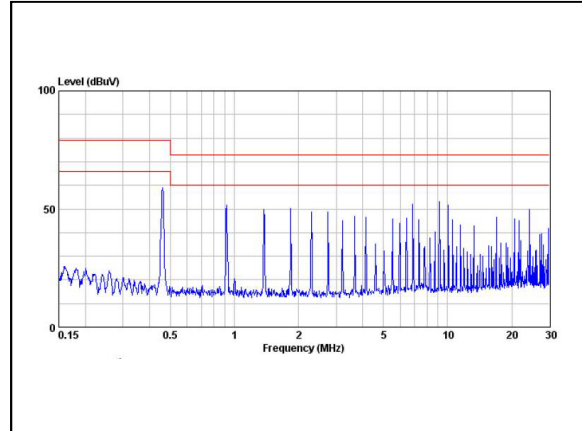

Figure 188: ATA00H18S-L Conduction Emission of EN550122 Class A
Vin = 24Vdc, Load: Io = 0.125A, Ta = 25 °C

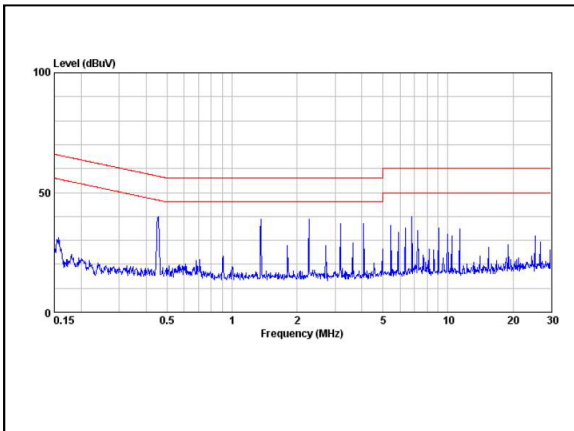

Figure 189: ATA00H18S-L Conduction Emission of EN550122 Class B
Vin = 24Vdc, Load: Io = 0.125A, Ta = 25 °C (with external filter)

ATA00AA18S-L Performance Curves

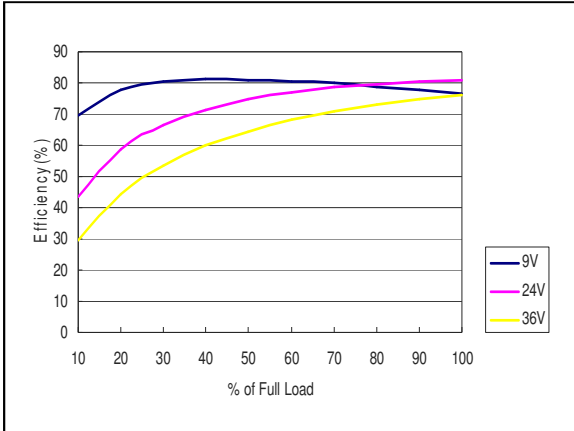

Figure 190: ATA00AA18S-L Efficiency Versus Output Current Curve
Vin = 9 to 36Vdc, Load: Io = 0 to ±0.3A, Ta = 25 °C

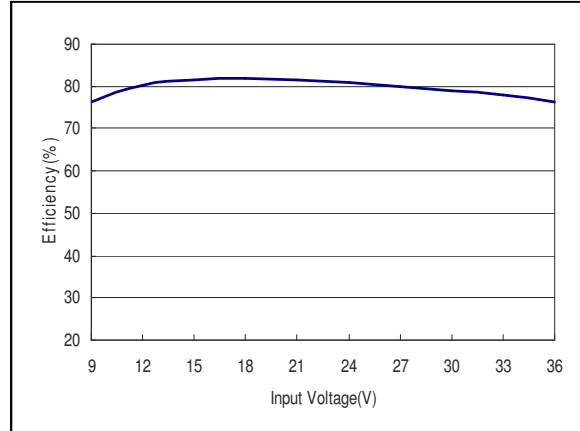

Figure 191: ATA00AA18S-L Efficiency Versus Input Voltage Curve
Vin = 9 to 36Vdc, Load: Io = ±0.3A, Ta = 25 °C

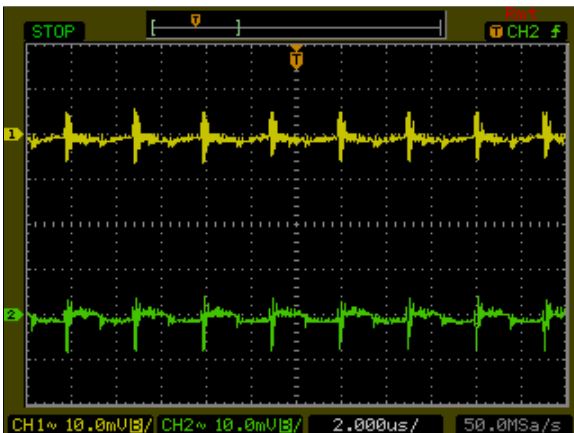

Figure 192: ATA00AA18S-L Ripple and Noise Measurement
Vin = 24Vdc, Load: Io = ±0.3A, Ta = 25 °C
Ch 1: V1
Ch 2: V2

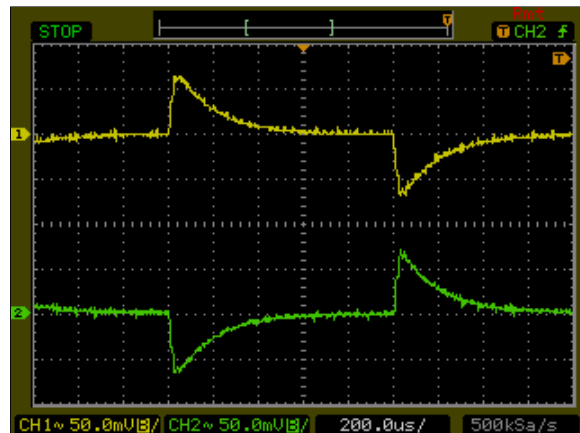

Figure 193: ATA00AA18S-L Transient Response
Vin = 24Vdc, Load: Io = 100% to 75% load change, Ta = 25 °C
Ch 1: V1
Ch 2: V2

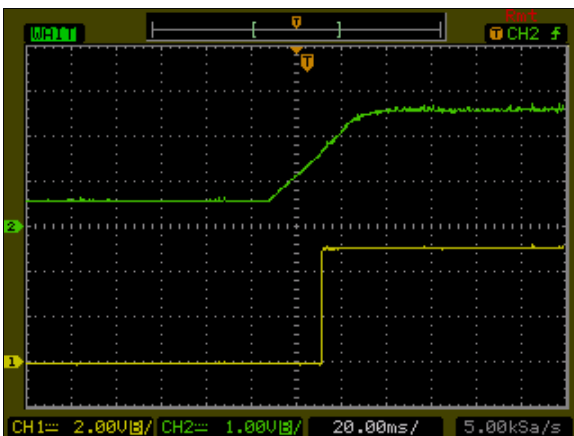

Figure 194: ATA00AA18S-L Output Voltage Startup Characteristic by Remote
Vin = 24Vdc, Load: Io = ±0.3A, Ta = 25 °C
Ch1: Vo
Ch2: Remote On/Off

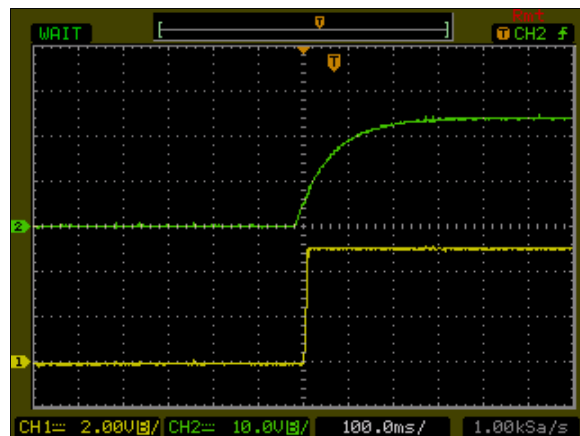

Figure 195: ATA00AA18S-L Output Voltage Startup Characteristic by Vin
Vin = 24Vdc, Load: Io = ±0.3A, Ta = 25 °C
Ch1: Vo
Ch2: Vin

ATA00AA18S-L Performance Curves

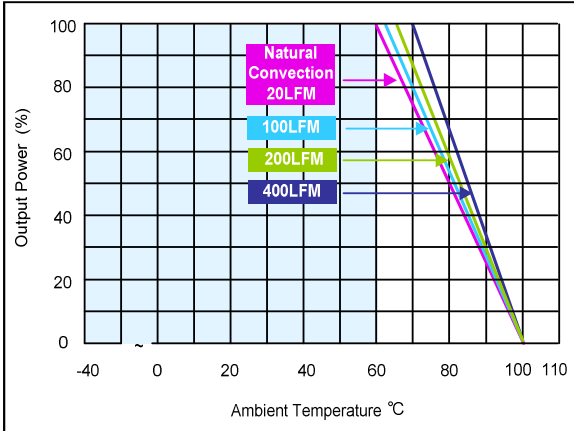

Figure 196: ATA00AA18S-L Derating Curves
Vin = 24Vdc, Load: Io = 0 to ±0.3A, Ta = 25 °C

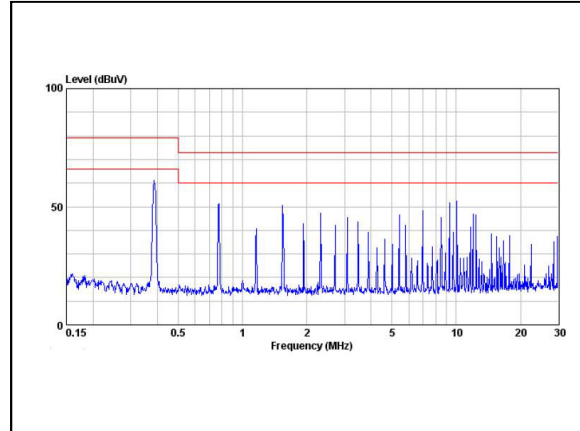

Figure 197: ATA00AA18S-L Conduction Emission of EN550122 Class A
Vin = 24Vdc, Load: Io = ±0.3A, Ta = 25 °C

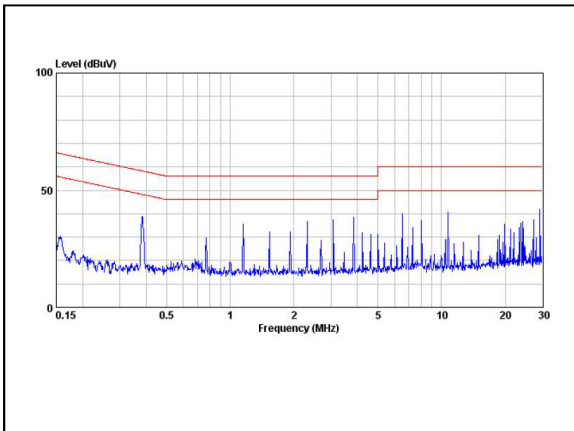

Figure 198: ATA00AA18S-L Conduction Emission of EN550122 Class B
Vin = 24Vdc, Load: Io = ±0.3A, Ta = 25 °C (with external filter)

ATA00BB18S-L Performance Curves

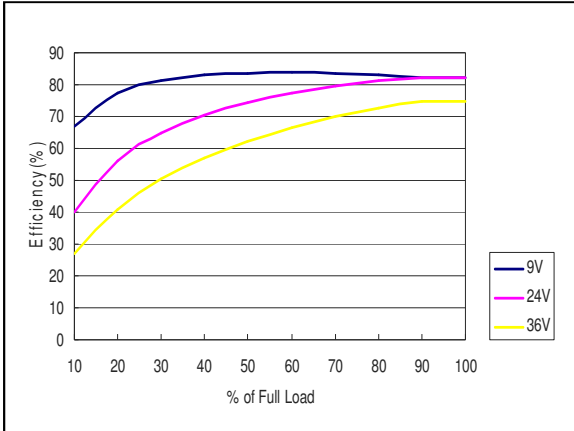

Figure 199: ATA00BB18S-L Efficiency Versus Output Current Curve
Vin = 9 to 36Vdc, Load: Io = 0 to ±0.125A, Ta = 25 °C

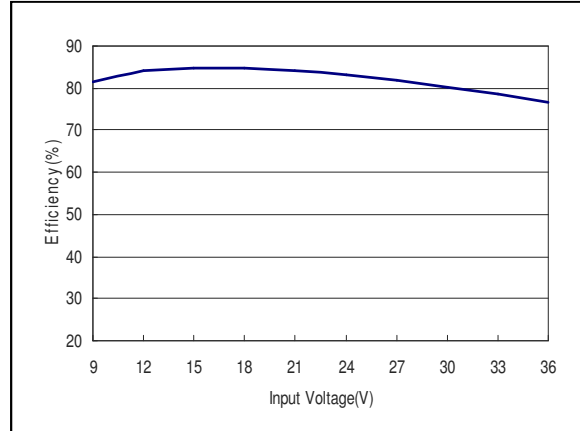

Figure 200: ATA00BB18S-L Efficiency Versus Input Voltage Curve
Vin = 9 to 36Vdc, Load: Io = ±0.125A, Ta = 25 °C

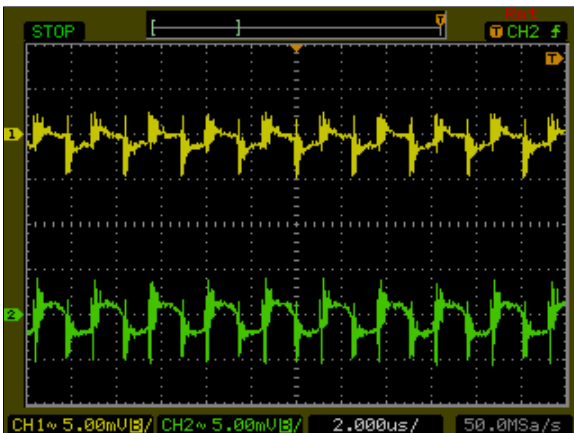

Figure 201: ATA00BB18S-L Ripple and Noise Measurement
Vin = 24Vdc, Load: Io = ±0.125A, Ta = 25 °C
Ch 1: V1
Ch 2: V2

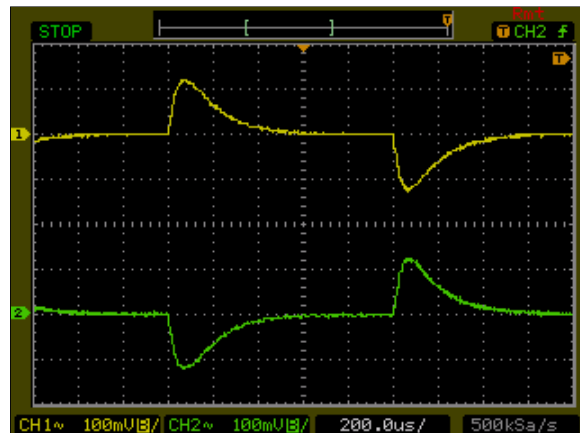

Figure 202: ATA00BB18S-L Transient Response
Vin = 24Vdc, Load: Io = 100% to 75% load change, Ta = 25 °C
Ch 1: V1
Ch 2: V2

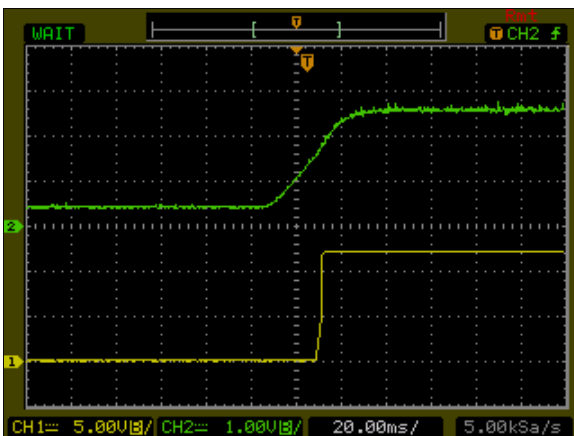

Figure 203: ATA00BB18S-L Output Voltage Startup Characteristic by Remote
Vin = 24Vdc, Load: Io = ±0.125A, Ta = 25 °C
Ch1: V1
Ch2: Remote On/Off

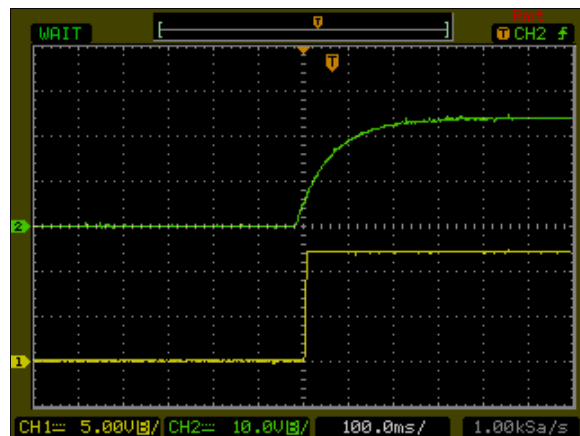

Figure 204: ATA00BB18S-L Output Voltage Startup Characteristic by Vin
Vin = 24Vdc, Load: Io = ±0.125A, Ta = 25 °C
Ch1: V1
Ch2: Vin

ATA00BB18S-L Performance Curves

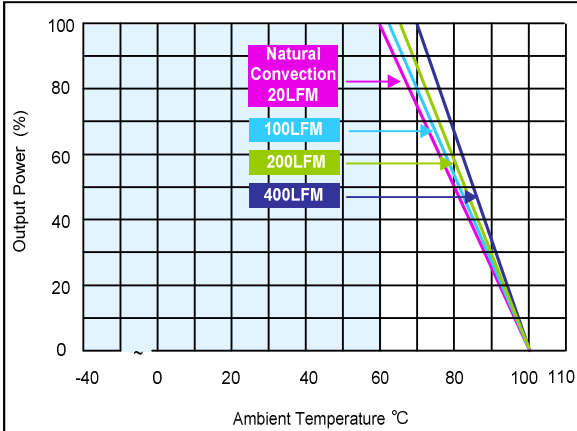

Figure 205: ATA00BB18S-L Derating Curves
Vin = 24Vdc, Load: Io = 0 to ±0.125A, Ta = 25 °C

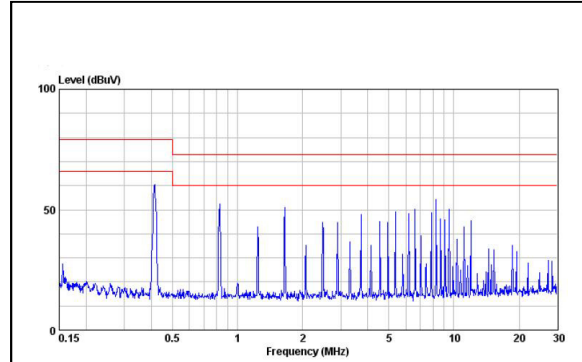

Figure 206: ATA00BB18S-L Conduction Emission of EN550122 Class A
Vin = 24Vdc, Load: Io = ±0.125A, Ta = 25 °C

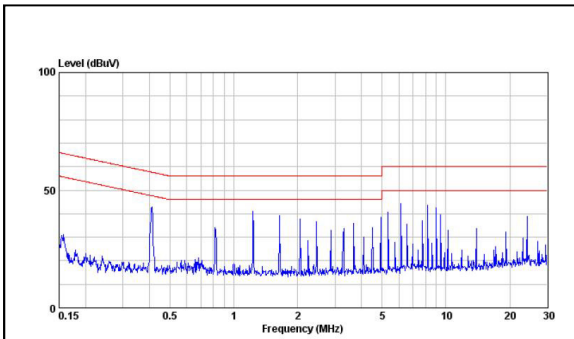

Figure 207: ATA00BB18S-L Conduction Emission of EN550122 Class B
Vin = 24Vdc, Load: Io = ±0.125A, Ta = 25 °C (with external filter)

ATA00CC18S-L Performance Curves

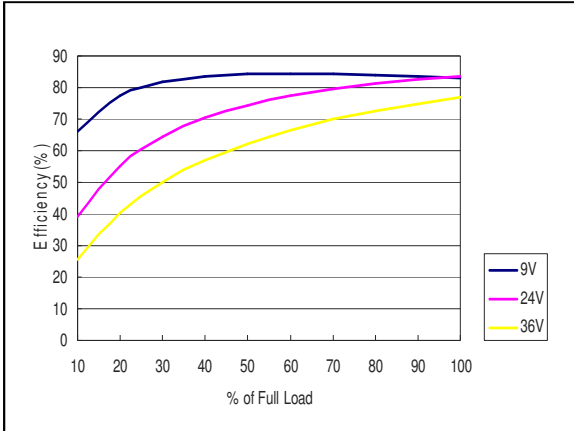

Figure 208: ATA00CC18S-L Efficiency Versus Output Current Curve
Vin = 9 to 36Vdc, Load: Io = 0 to ±0.1A, Ta = 25 °C

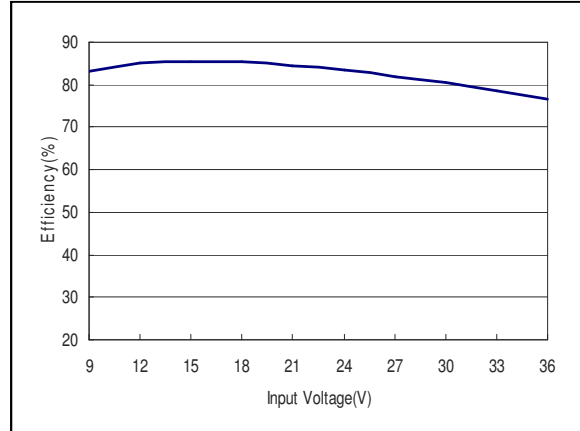

Figure 209: ATA00CC18S-L Efficiency Versus Input Voltage Curve
Vin = 9 to 36Vdc, Load: Io = ±0.1A, Ta = 25 °C

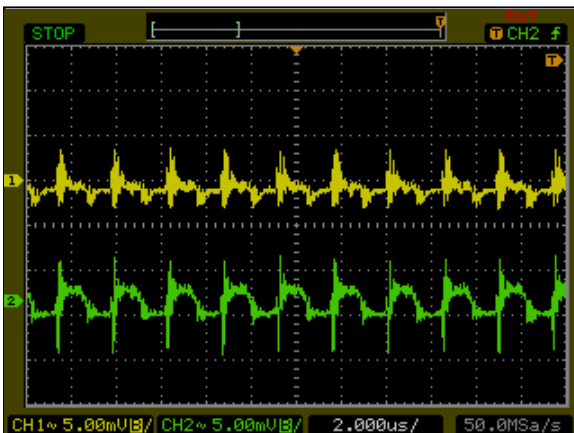

Figure 210: ATA00CC18S-L Ripple and Noise Measurement
Vin = 24Vdc, Load: Io = ±0.1A, Ta = 25 °C
Ch 1: V1
Ch 2: V2

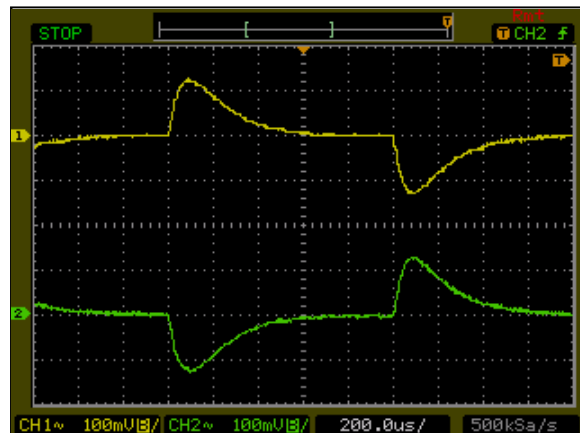

Figure 211: ATA00CC18S-L Transient Response
Vin = 24Vdc, Load: Io = 100% to 75% load change, Ta = 25 °C
Ch 1: V1
Ch 2: V2

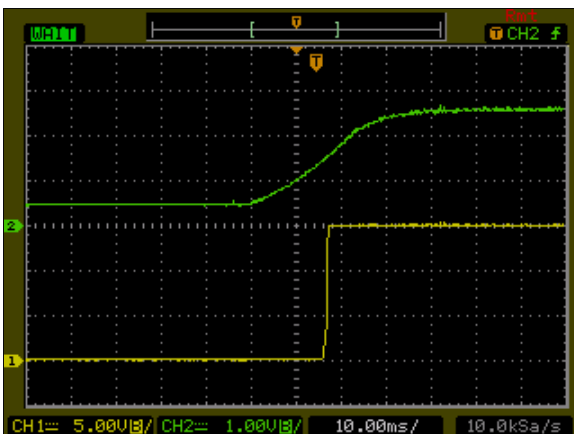

Figure 212: ATA00CC18S-L Output Voltage Startup Characteristic by Remote
Vin = 24Vdc, Load: Io = ±0.1A, Ta = 25 °C
Ch1: V1
Ch2: Remote On/Off

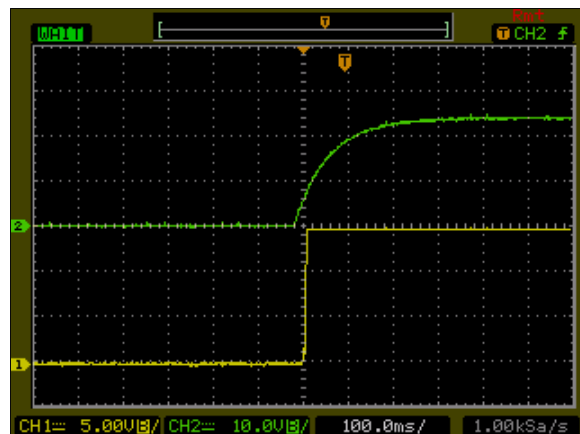

Figure 213: ATA00CC18S-L Output Voltage Startup Characteristic by Vin
Vin = 24Vdc, Load: Io = ±0.1A, Ta = 25 °C
Ch1: V1
Ch2: Vin

ATA00CC18S-L Performance Curves

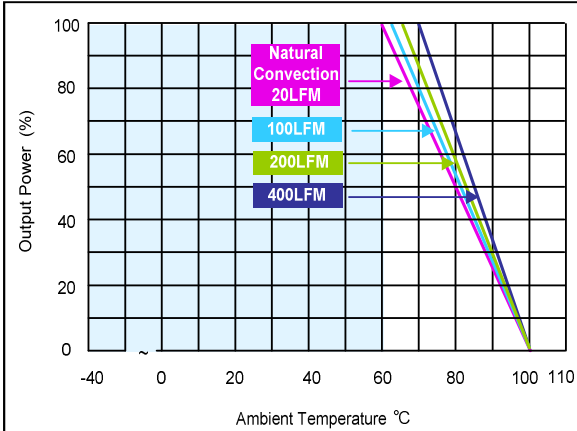

Figure 214: ATA00CC18S-L Derating Curves
Vin = 24Vdc, Load: Io = 0 to ±0.1A, Ta = 25 °C

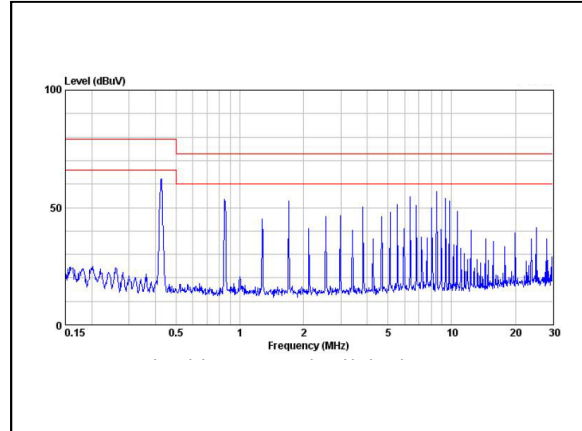

Figure 215: ATA00CC18S-L Conduction Emission of EN550122 Class A
Vin = 24Vdc, Load: Io = ±0.1A, Ta = 25 °C

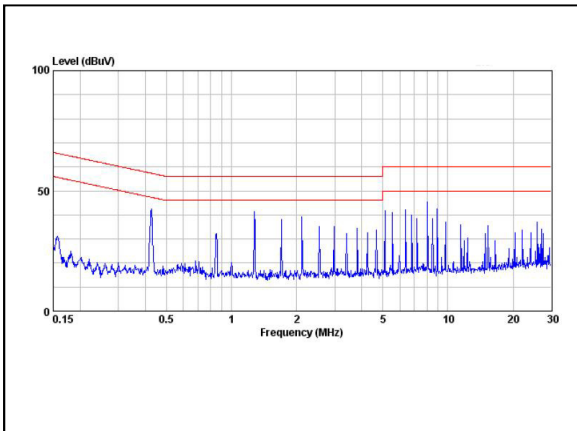

Figure 216: ATA00CC18S-L Conduction Emission of EN550122 Class B
Vin = 24Vdc, Load: Io = ±0.1A, Ta = 25 °C (with external filter)

ATA00F36S-L Performance Curves

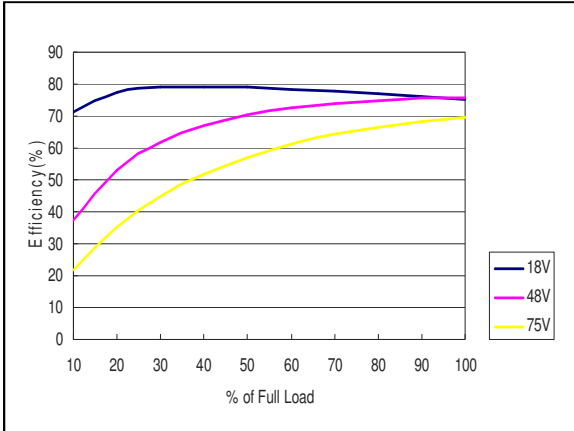

Figure 217:ATA00F36S-L Efficiency Versus Output Current Curve
Vin = 18 to 75Vdc, Load: Io = 0 to 0.6A, Ta = 25 °C

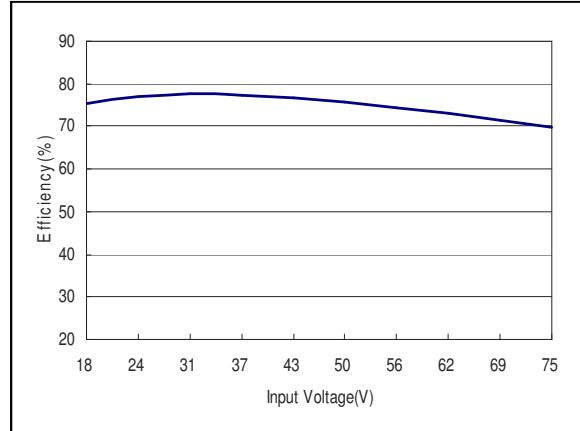

Figure 218:ATA00F36S-L Efficiency Versus Input Voltage Curve
Vin = 18 to 75Vdc, Load: Io = 0.6A, Ta = 25 °C

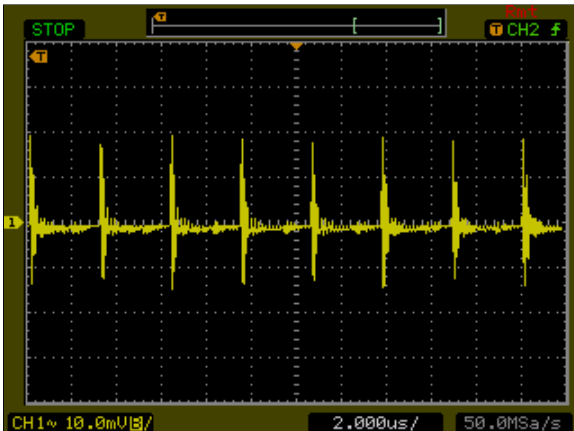

Figure 219: ATA00F36S-L Ripple and Noise Measurement
Vin = 48Vdc, Load: Io = 0.6A, Ta = 25 °C
Ch 1: Vo

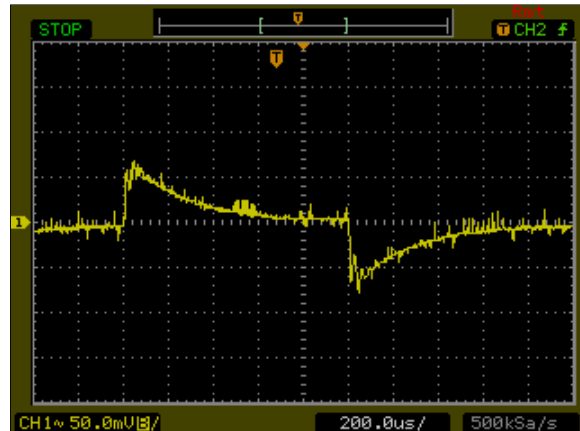

Figure 220: ATA00F36S-L Transient Response
Vin = 48Vdc, Load: Io = 100% to 75% load change, Ta = 25 °C
Ch 1: Vo

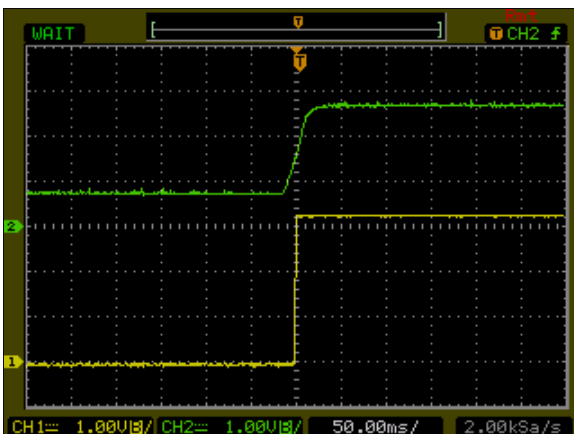

Figure 221: ATA00F36S-L Output Voltage Startup Characteristic by Remote
Vin = 48Vdc, Load: Io = 0.6A, Ta = 25 °C
Ch1: Vo
Ch2: Remote On/Off

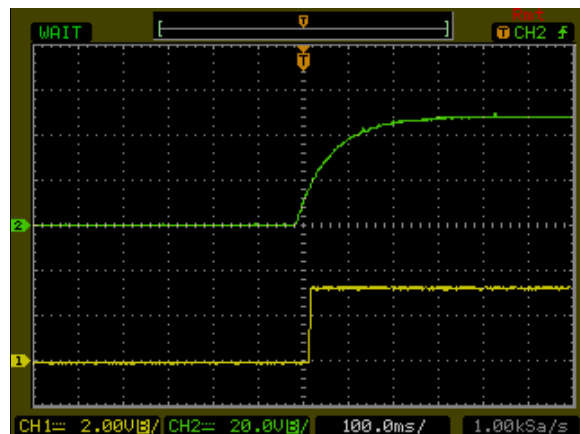

Figure 222: ATA00F36S-L Output Voltage Startup Characteristic by Vin
Vin = 48Vdc, Load: Io = 0.6A, Ta = 25 °C
Ch1: Vo
Ch2: Vin

ATA00F36S-L Performance Curves

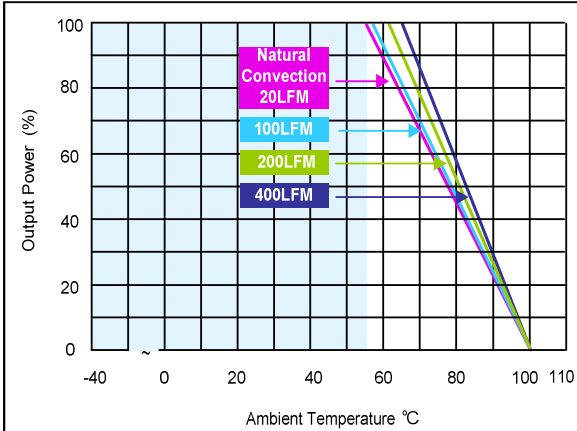

Figure 223: ATA00F36S-L Derating Curves
Vin = 48Vdc, Load: Io = 0 to 0.6A, Ta = 25 °C

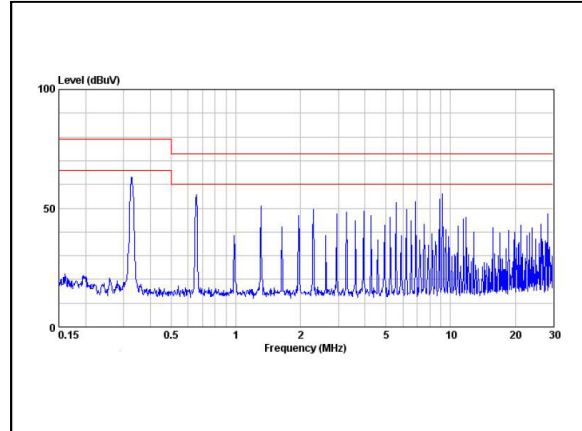

Figure 224: ATA00F36S-L Conduction Emission of EN550122 Class A
Vin = 48Vdc, Load: Io = 0.6A, Ta = 25 °C

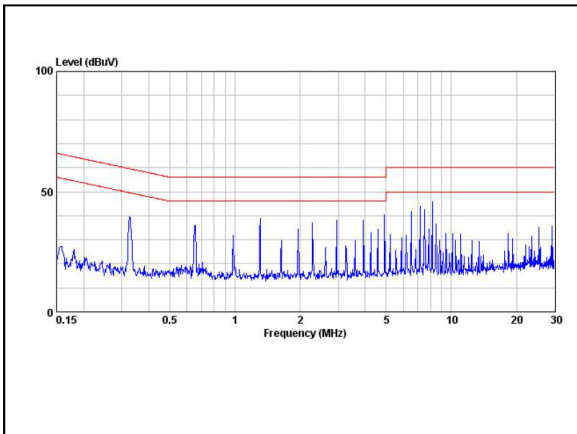

Figure 225: ATA00F36S-L Conduction Emission of EN550122 Class B
Vin = 48Vdc, Load: Io = 0.6A, Ta = 25 °C (with external filter)

ATA00A36S-L Performance Curves

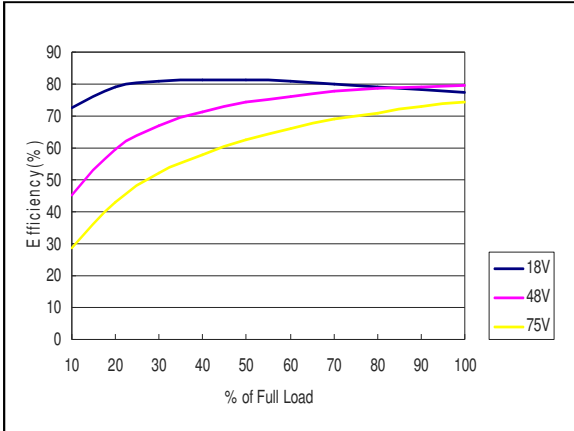

Figure 226: ATA00A36S-L Efficiency Versus Output Current Curve
Vin = 18 to 75Vdc, Load: Io = 0 to 0.6A, Ta = 25 °C

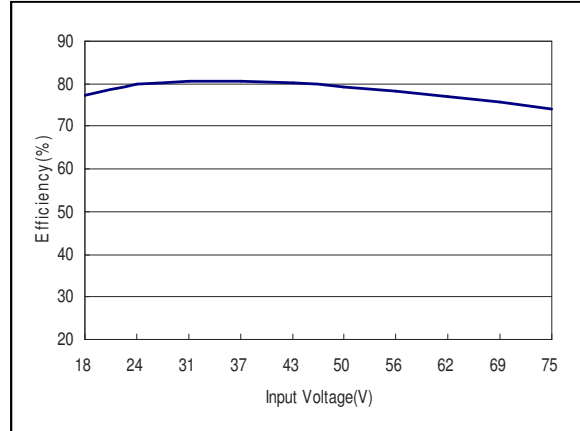

Figure 227: ATA00A36S-L Efficiency Versus Input Voltage Curve
Vin = 18 to 75Vdc, Load: Io = 0.6A, Ta = 25 °C

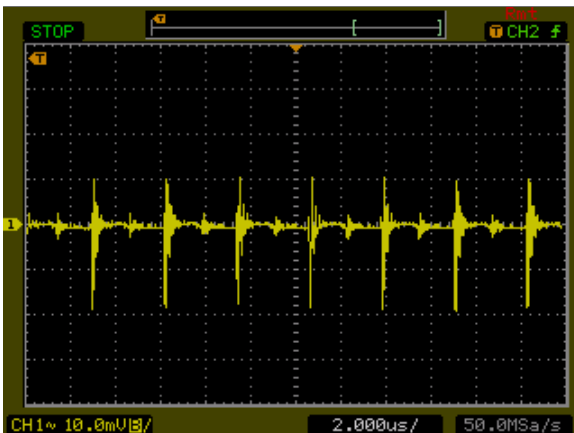

Figure 228: ATA00A36S-L Ripple and Noise Measurement
Vin = 48Vdc, Load: Io = 0.6A, Ta = 25 °C
Ch 1: Vo

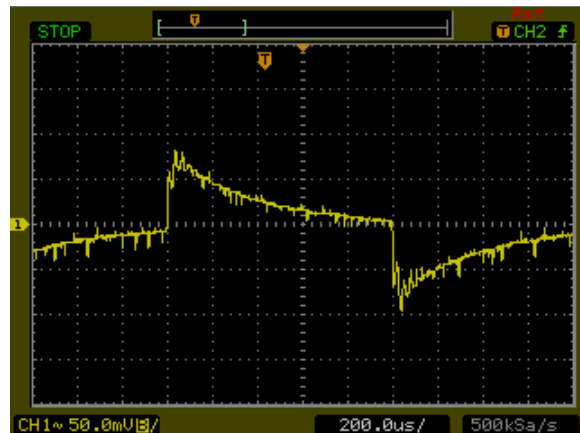

Figure 229: ATA00A36S-L Transient Response
Vin = 48Vdc, Load: Io = 100% to 75% load change, Ta = 25 °C
Ch 1: Vo

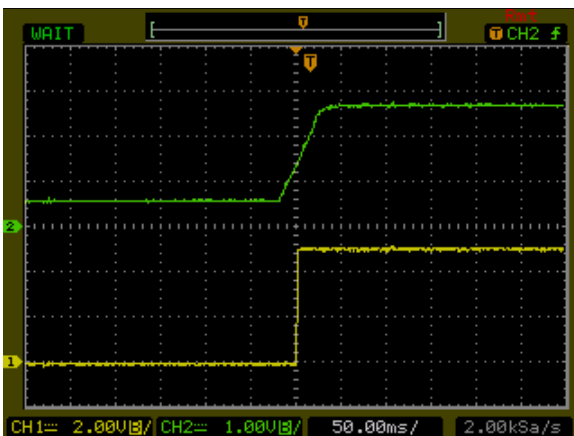

Figure 230: ATA00A36S-L Output Voltage Startup Characteristic by Remote
Vin = 48Vdc, Load: Io = 0.6A, Ta = 25 °C
Ch1: Vo
Ch2: Remote On/Off

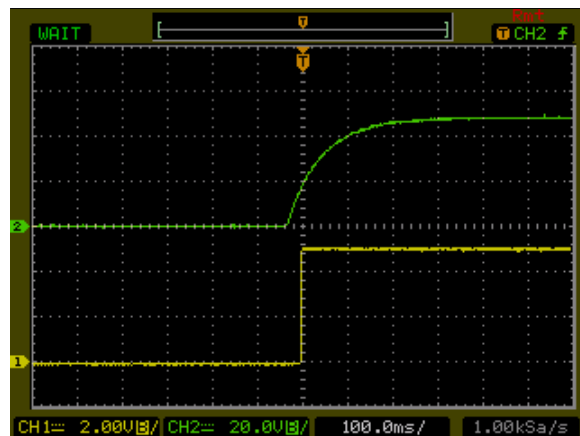

Figure 231: ATA00A36S-L Output Voltage Startup Characteristic by Vin
Vin = 48Vdc, Load: Io = 0.6A, Ta = 25 °C
Ch1: Vo
Ch2: Vin

ATA00A36S-L Performance Curves

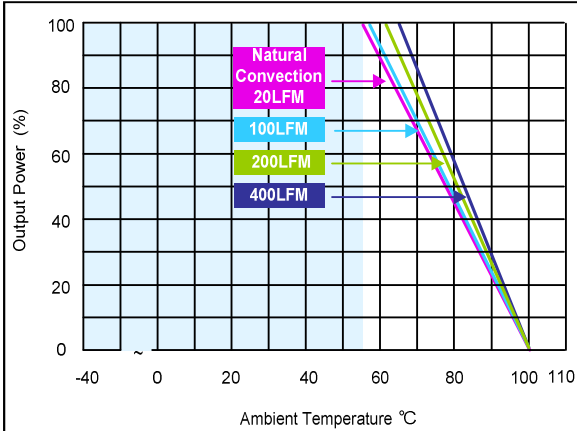

Figure 232: ATA00A36S-L Derating Curves
Vin = 48Vdc, Load: Io = 0 to 0.6A, Ta = 25 °C

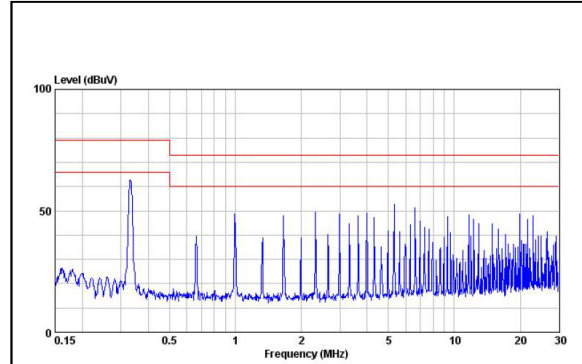

Figure 233: ATA00A36S-L Conduction Emission of EN550122 Class A
Vin = 48Vdc, Load: Io = 0.6A, Ta = 25 °C

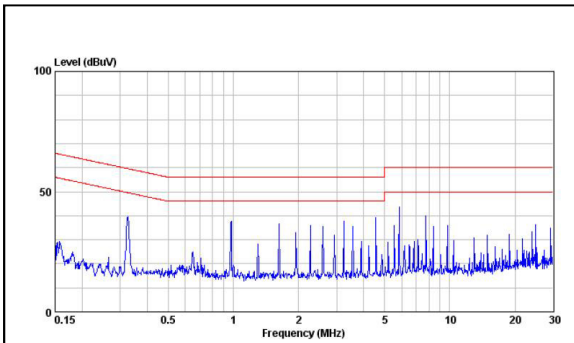

Figure 234: ATA00A36S-L Conduction Emission of EN550122 Class B
Vin = 48Vdc, Load: Io = 0.6A, Ta = 25 °C (with external filter)

ATA00B36S-L Performance Curves

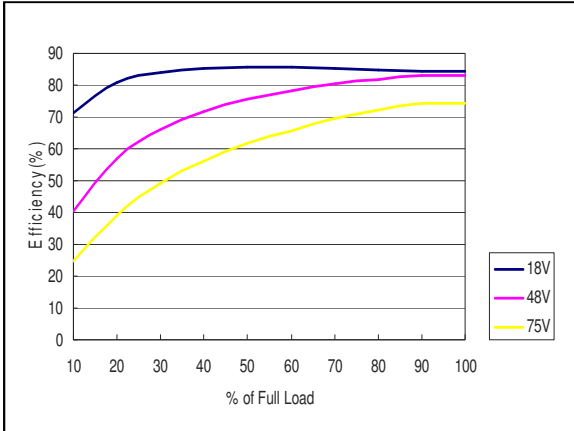

Figure 235: ATA00B36S-L Efficiency Versus Output Current Curve
Vin = 18 to 75Vdc, Load: Io = 0 to 0.25A, Ta = 25 °C

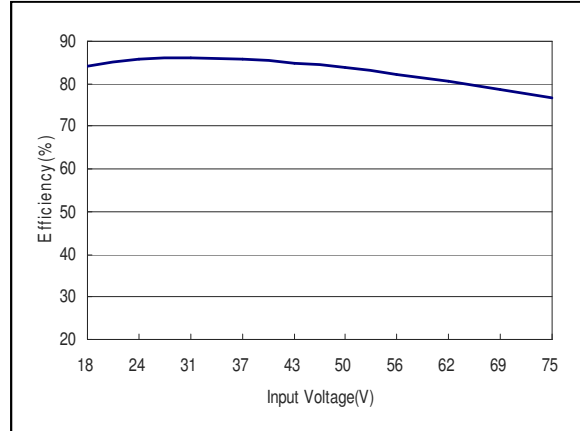

Figure 236: ATA00B36S-L Efficiency Versus Input Voltage Curve
Vin = 18 to 75Vdc, Load: Io = 0.25A, Ta = 25 °C

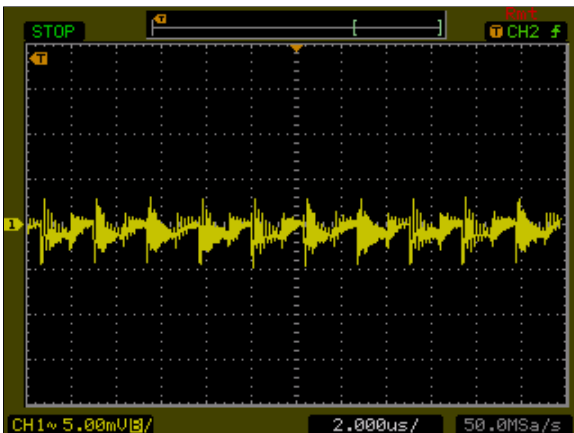

Figure 237: ATA00B36S-L Ripple and Noise Measurement
Vin = 48Vdc, Load: Io = 0.25A, Ta = 25 °C
Ch 1: Vo

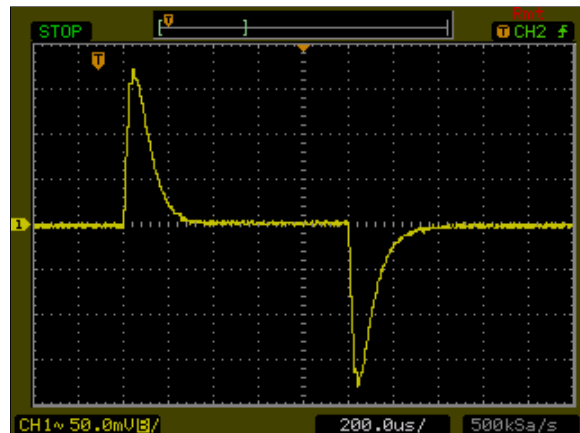

Figure 238: ATA00B36S-L Transient Response
Vin = 48Vdc, Load: Io = 100% to 75% load change, Ta = 25 °C
Ch 1: Vo

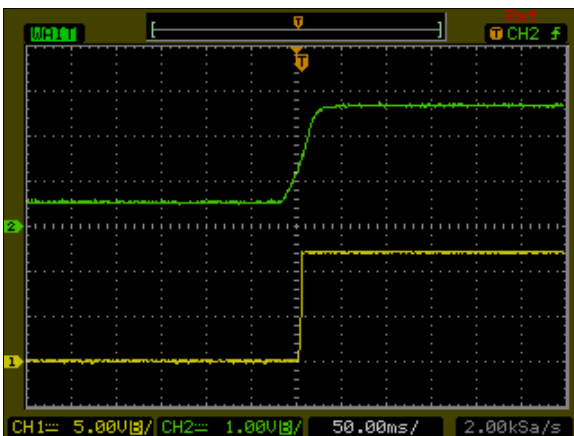

Figure 239: ATA00B36S-L Output Voltage Startup Characteristic by Remote
Vin = 48Vdc, Load: Io = 0.25A, Ta = 25 °C
Ch1: Vo
Ch2: Remote On/Off

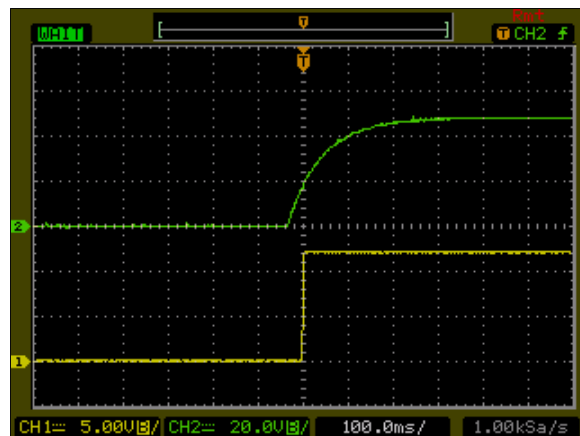

Figure 240: ATA00B36S-L Output Voltage Startup Characteristic by Vin
Vin = 48Vdc, Load: Io = 0.25A, Ta = 25 °C
Ch1: Vo
Ch2: Vin

ATA00B36S-L Performance Curves

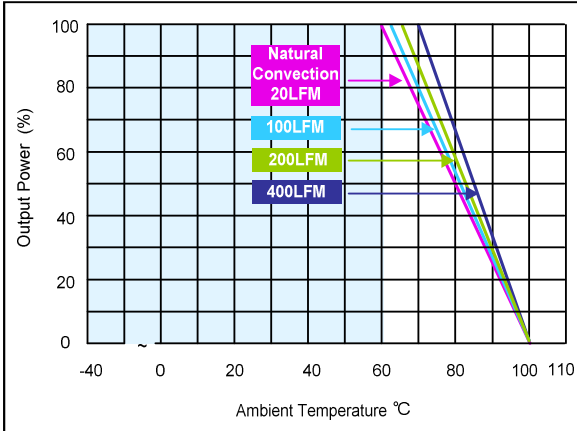

Figure 241: ATA00B36S-L Derating Curves
Vin = 48Vdc, Load: Io = 0 to 0.25A, Ta = 25 °C

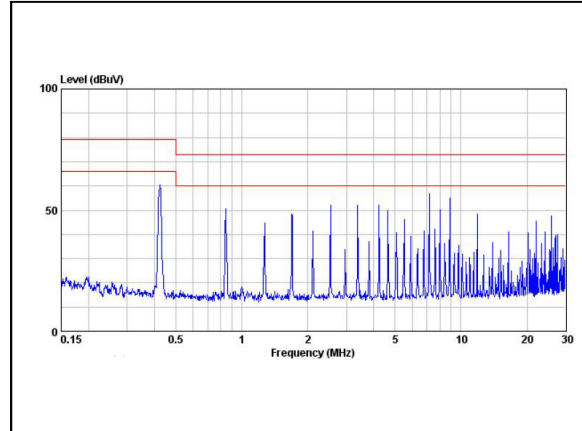

Figure 242: ATA00B36S-L Conduction Emission of EN550122 Class A
Vin = 48Vdc, Load: Io = 0.25A, Ta = 25 °C

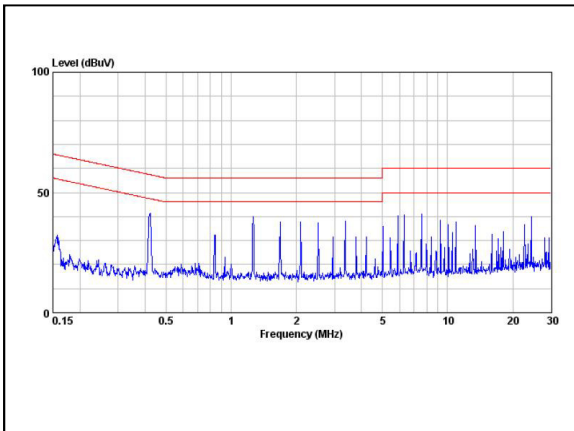

Figure 243: ATA00B36S-L Conduction Emission of EN550122 Class B
Vin = 48Vdc, Load: Io = 0.25A, Ta = 25 °C (with external filter)

ATA00C36S-L Performance Curves

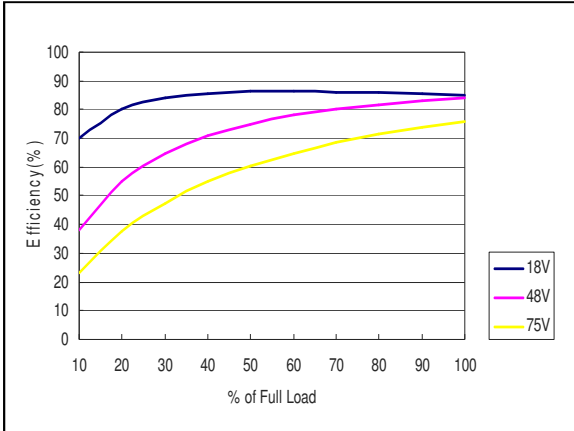

Figure 244: ATA00C36S-L Efficiency Versus Output Current Curve
Vin = 18 to 75Vdc, Load: Io = 0 to 0.2A, Ta = 25 °C

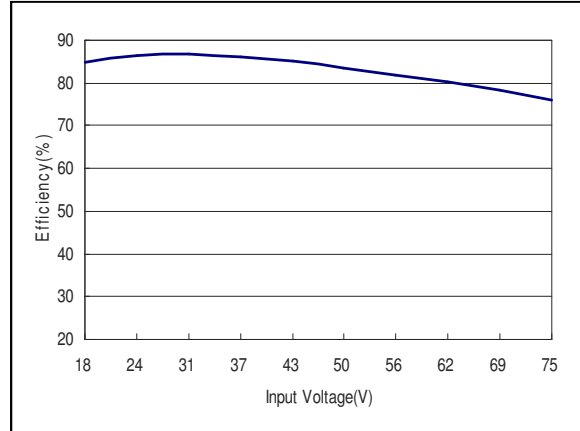

Figure 245: ATA00C36S-L Efficiency Versus Input Voltage Curve
Vin = 18 to 75Vdc, Load: Io = 0.2A, Ta = 25 °C

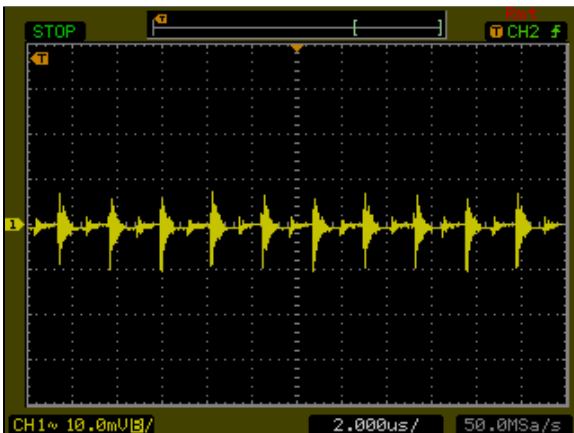

Figure 246: ATA00C36S-L Ripple and Noise Measurement
Vin = 48Vdc, Load: Io = 0.2A, Ta = 25 °C
Ch 1: Vo

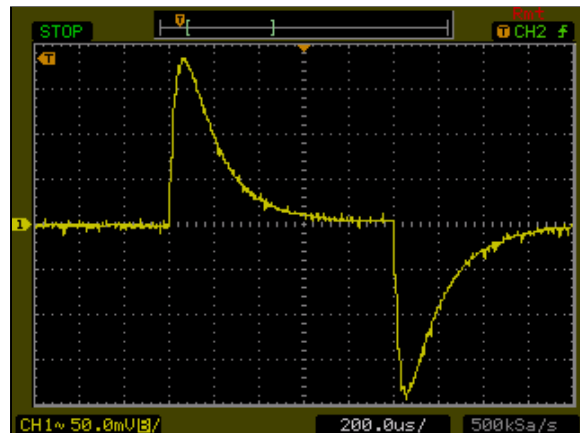

Figure 247: ATA00C36S-L Transient Response
Vin = 48Vdc, Load: Io = 100% to 75% load change, Ta = 25 °C
Ch 1: Vo

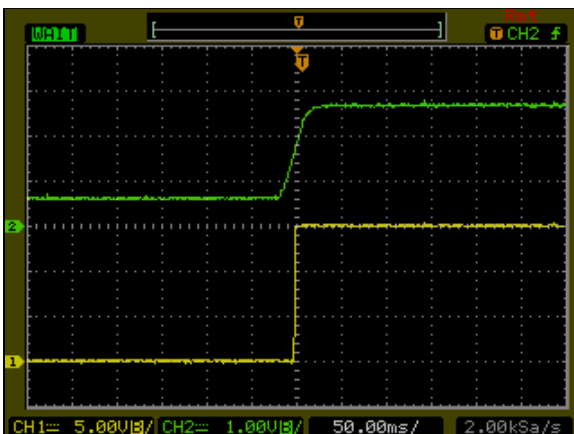

Figure 248: ATA00C36S-L Output Voltage Startup Characteristic by Remote
Vin = 48Vdc, Load: Io = 0.2A, Ta = 25 °C
Ch1: Vo
Ch2: Remote On/Off

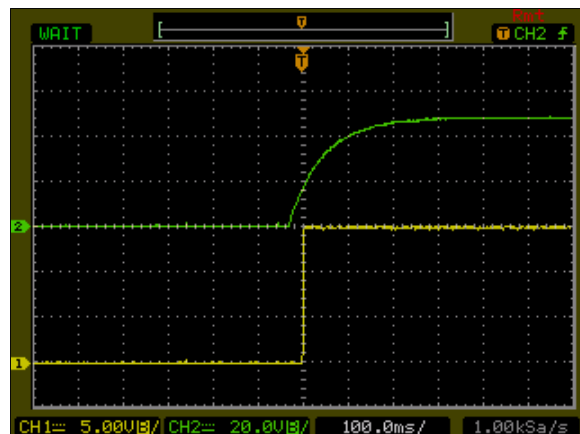

Figure 249: ATA00C36S-L Output Voltage Startup Characteristic by Vin
Vin = 48Vdc, Load: Io = 0.2A, Ta = 25 °C
Ch1: Vo
Ch2: Vin

ATA00C36S-L Performance Curves

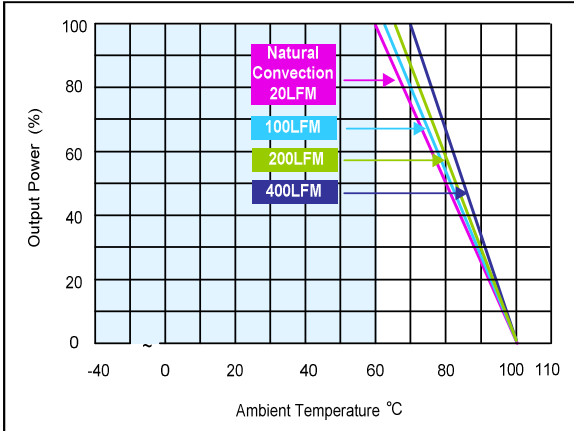

Figure 250: ATA00C36S-L Derating Curves
Vin = 48Vdc, Load: Io = 0 to 0.2A, Ta = 25 °C

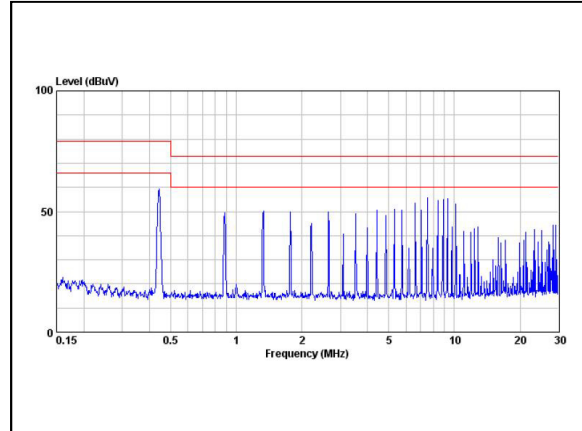

Figure 251: ATA00C36S-L Conduction Emission of EN550122 Class A
Vin = 48Vdc, Load: Io = 0.2A, Ta = 25 °C

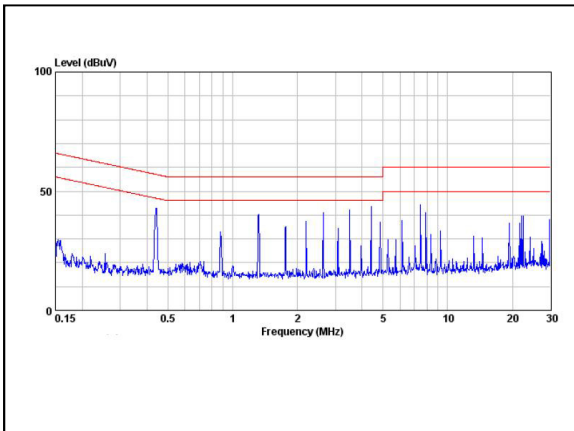

Figure 252: ATA00C36S-L Conduction Emission of EN550122 Class B
Vin = 48Vdc, Load: Io = 0.2A, Ta = 25 °C (with external filter)

ATA00H36S-L Performance Curves

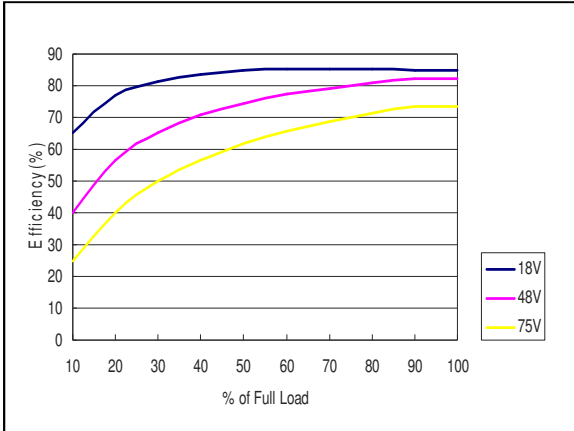

Figure 253: ATA00H36S-L Efficiency Versus Output Current Curve
Vin = 18 to 75Vdc, Load: Io = 0 to 0.125A, Ta = 25 °C

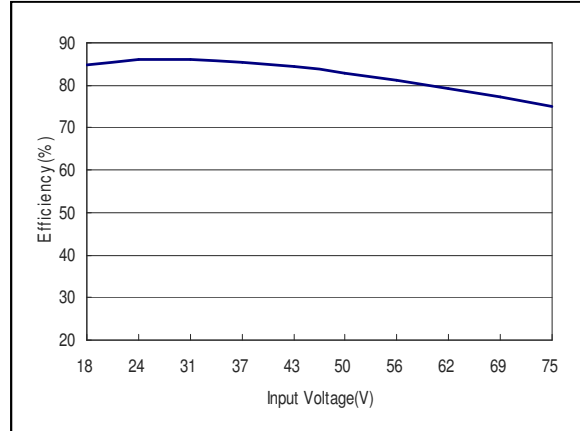

Figure 254: ATA00H36S-L Efficiency Versus Input Voltage Curve
Vin = 18 to 75Vdc, Load: Io = 0.125A, Ta = 25 °C

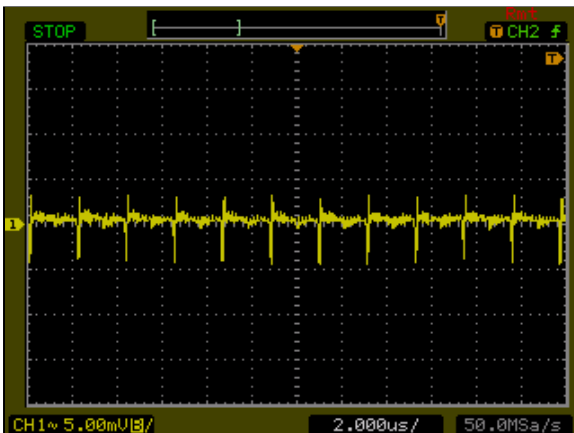

Figure 255: ATA00H36S-L Ripple and Noise Measurement
Vin = 48Vdc, Load: Io = 0.125A, Ta = 25 °C
Ch 1: Vo

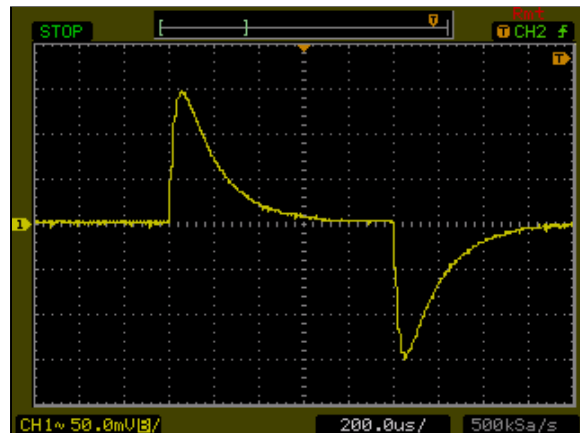

Figure 256: ATA00H36S-L Transient Response
Vin = 48Vdc, Load: Io = 100% to 75% load change, Ta = 25 °C
Ch 1: Vo

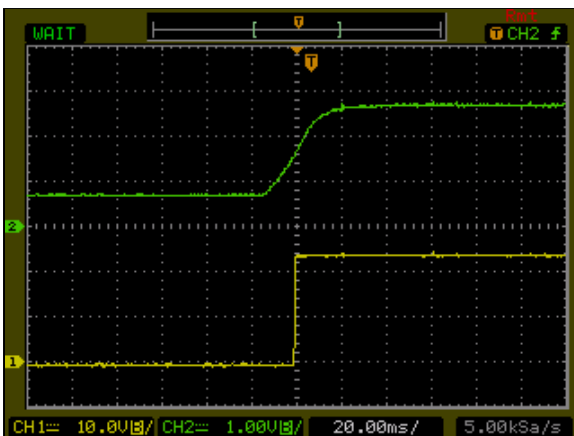

Figure 257: ATA00H36S-L Output Voltage Startup Characteristic by Remote
Vin = 48Vdc, Load: Io = 0.125A, Ta = 25 °C
Ch1: Vo
Ch2: Remote On/Off

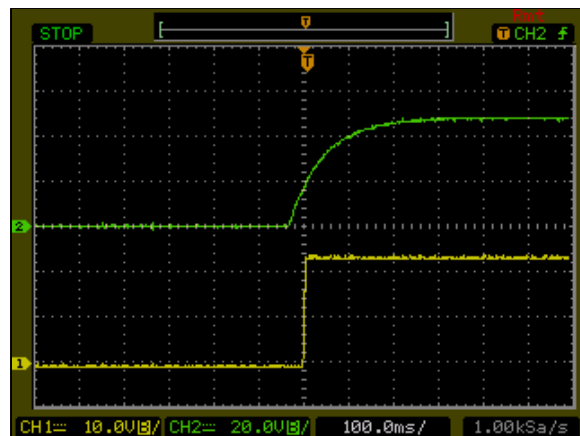

Figure 258: ATA00H36S-L Output Voltage Startup Characteristic by Vin
Vin = 48Vdc, Load: Io = 0.125A, Ta = 25 °C
Ch1: Vo
Ch2: Vin

ATA00H36S-L Performance Curves

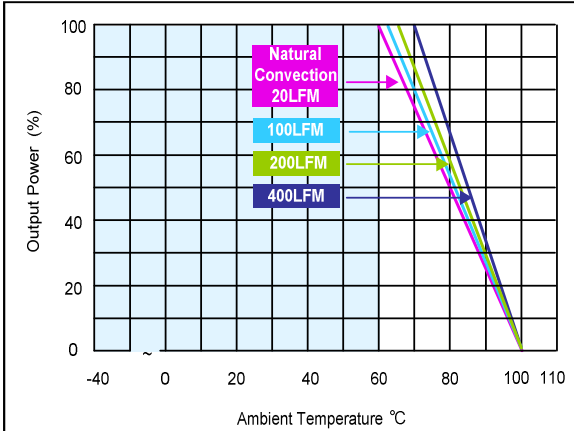

Figure 259: ATA00H36S-L Derating Curves
Vin = 48Vdc, Load: Io = 0 to 0.125A, Ta = 25 °C

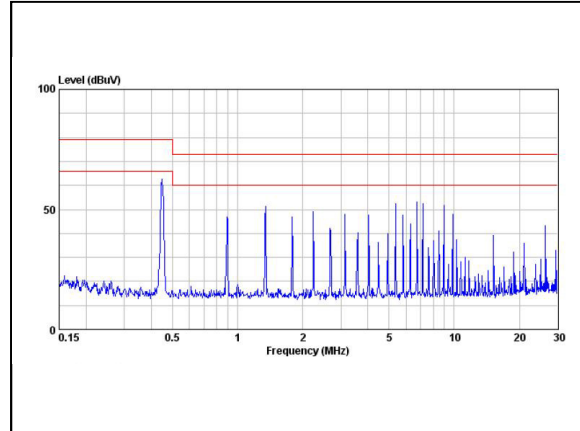

Figure 260: ATA00H36S-L Conduction Emission of EN550122 Class A
Vin = 48Vdc, Load: Io = 0.125A, Ta = 25 °C

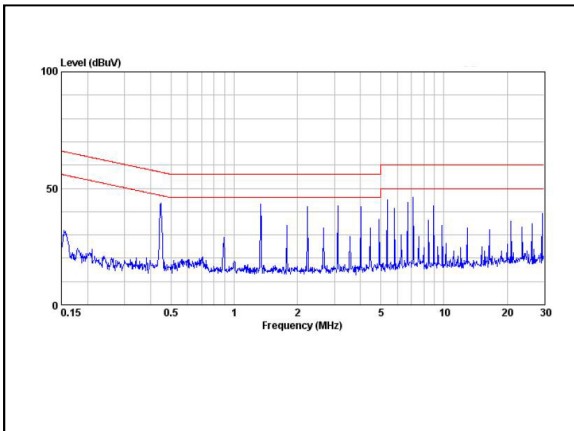

Figure 261: ATA00H36S-L Conduction Emission of EN550122 Class B
Vin = 48Vdc, Load: Io = 0.125A, Ta = 25 °C (with external filter)

ATA00AA36S-L Performance Curves

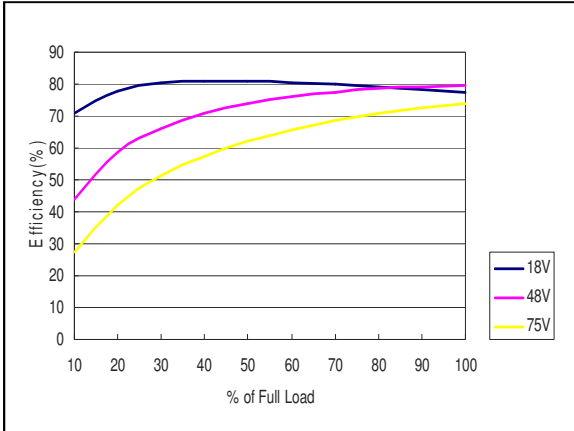

Figure 262: ATA00AA36S-L Efficiency Versus Output Current Curve
Vin = 18 to 75Vdc, Load: Io = 0 to ±0.3A, Ta = 25 °C

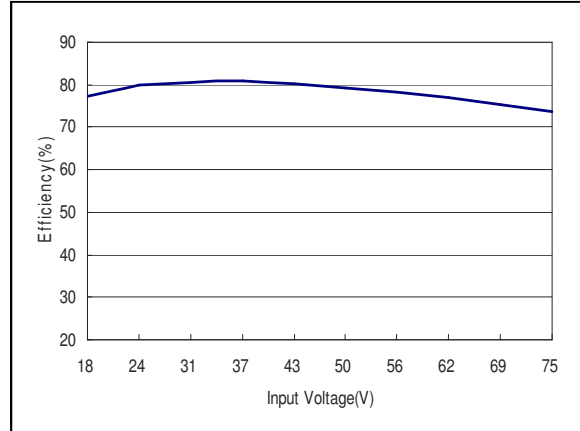

Figure 263: ATA00AA36S-L Efficiency Versus Input Voltage Curve
Vin = 18 to 75Vdc, Load: Io = ±0.3A, Ta = 25 °C

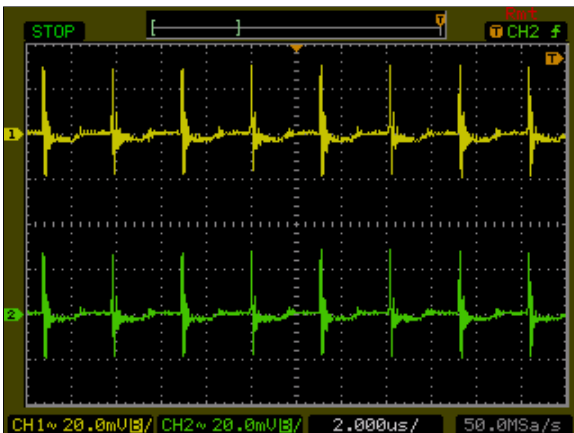

Figure 264: ATA00AA36S-L Ripple and Noise Measurement
Vin = 48Vdc, Load: Io = ±0.3A, Ta = 25 °C
Ch 1: V1
Ch 2: V2

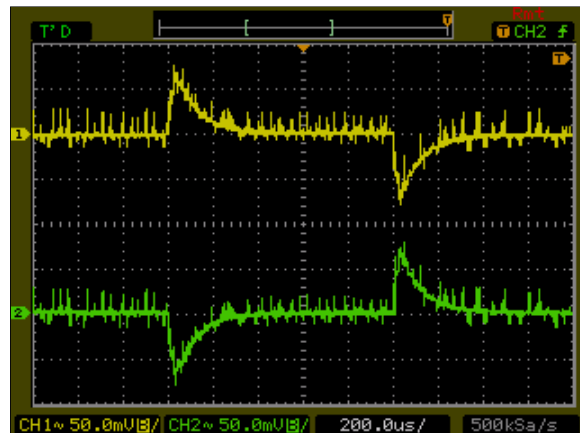

Figure 265: ATA00AA36S-L Transient Response
Vin = 48Vdc, Load: Io = 100% to 75% load change, Ta = 25 °C
Ch 1: V1
Ch 2: V2

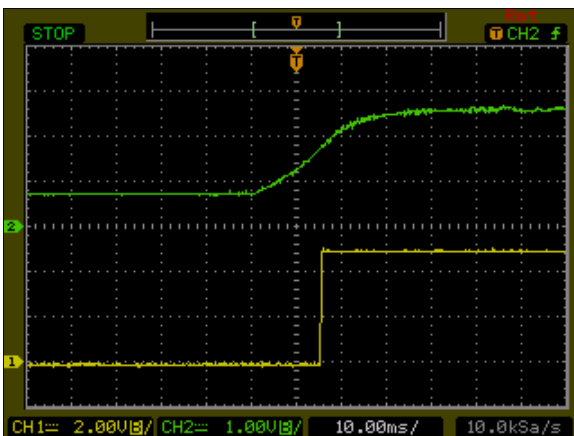

Figure 266: ATA00AA36S-L Output Voltage Startup Characteristic by Remote
Vin = 48Vdc, Load: Io = ±0.3A, Ta = 25 °C
Ch1: V1
Ch2: Remote On/Off

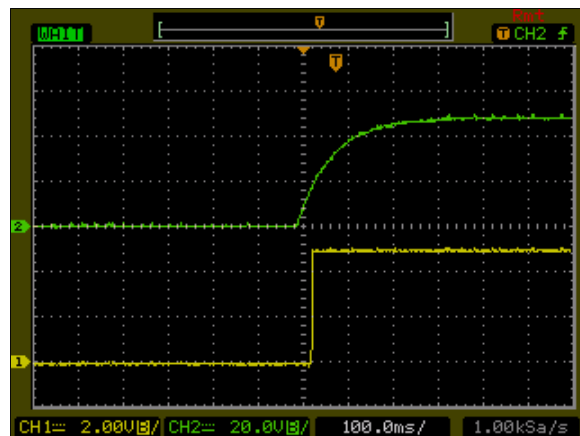

Figure 267: ATA00AA36S-L Output Voltage Startup Characteristic by Vin
Vin = 48Vdc, Load: Io = ±0.3A, Ta = 25 °C
Ch1: V1
Ch2: Vin

ATA00AA36S-L Performance Curves

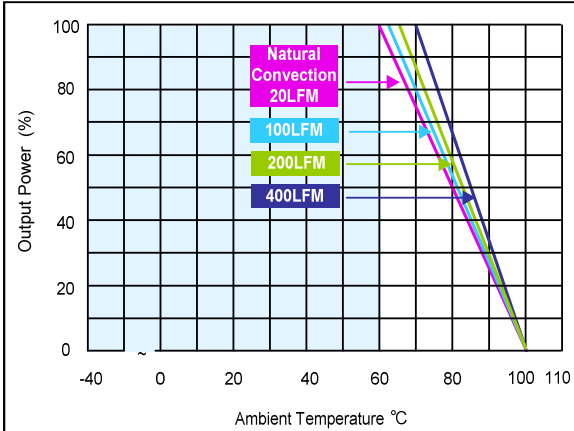

Figure 268: ATA00AA36S-L Derating Curves
Vin = 48Vdc, Load: Io = 0 to ±0.3A, Ta = 25 °C

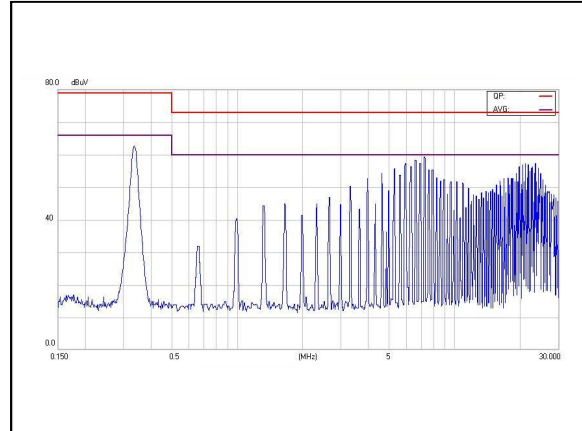

Figure 269: ATA00AA36S-L Conduction Emission of EN550122 Class A
Vin = 48Vdc, Load: Io = ±0.3A, Ta = 25 °C

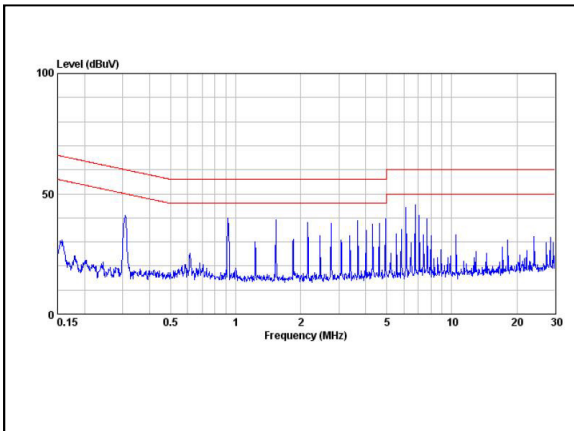

Figure 270: ATA00AA36S-L Conduction Emission of EN550122 Class B
Vin = 48Vdc, Load: Io = ±0.3A, Ta = 25 °C (with external filter)

ATA00BB36S-L Performance Curves

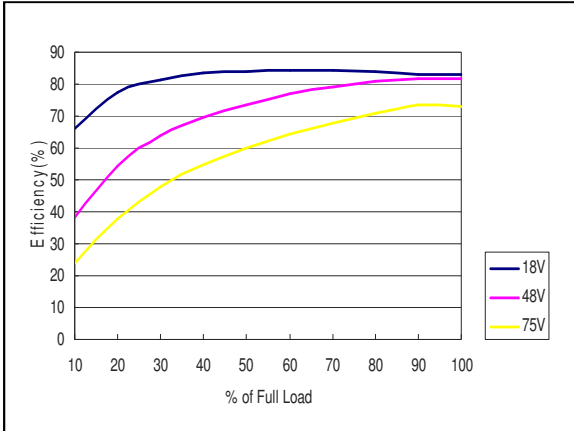

Figure 271: ATA00BB36S-L Efficiency Versus Output Current Curve
Vin = 18 to 75Vdc, Load: Io = 0 to ±0.125A, Ta = 25 °C

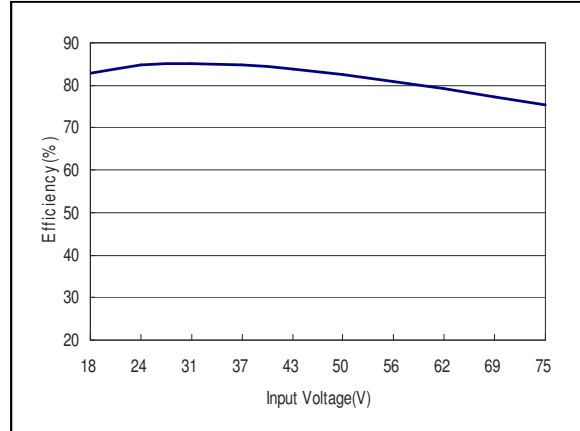

Figure 272: ATA00BB36S-L Efficiency Versus Input Voltage Curve
Vin = 18 to 75Vdc, Load: Io = ±0.125A, Ta = 25 °C

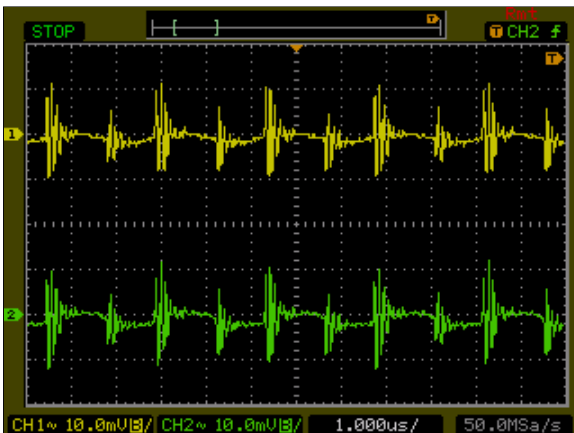

Figure 273: ATA00BB36S-L Ripple and Noise Measurement
Vin = 48Vdc, Load: Io = ±0.125A, Ta = 25 °C
Ch 1: V1
Ch 2: V2

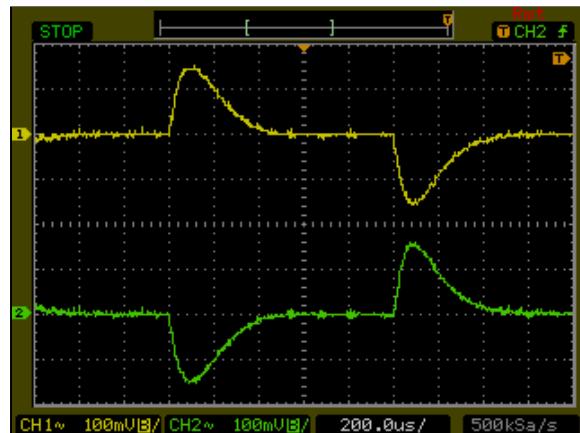

Figure 274: ATA00BB36S-L Transient Response
Vin = 48Vdc, Load: Io = 100% to 75% load change, Ta = 25 °C
Ch 1: V1
Ch 2: V2

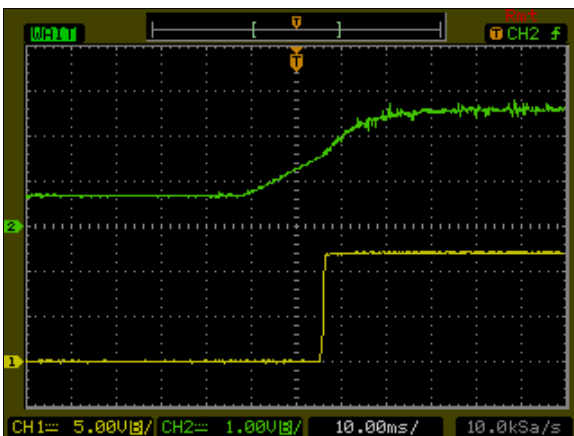

Figure 275: ATA00BB36S-L Output Voltage Startup Characteristic by Remote
Vin = 48Vdc, Load: Io = ±0.125A, Ta = 25 °C
Ch1: V1
Ch2: Remote On/Off

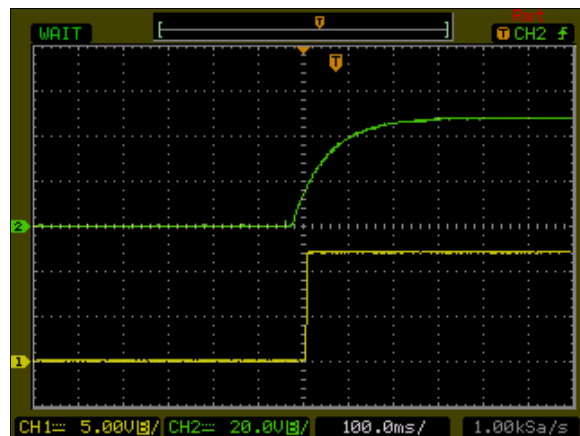

Figure 276: ATA00BB36S-L Output Voltage Startup Characteristic by Vin
Vin = 48Vdc, Load: Io = ±0.125A, Ta = 25 °C
Ch1: V1
Ch2: Vin

ATA00BB36S-L Performance Curves

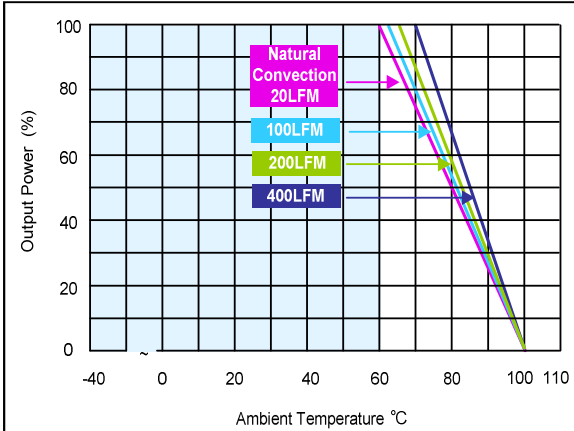

Figure 277: ATA00BB36S-L Derating Curves
Vin = 48Vdc, Load: Io = 0 to ±0.125A, Ta = 25 °C

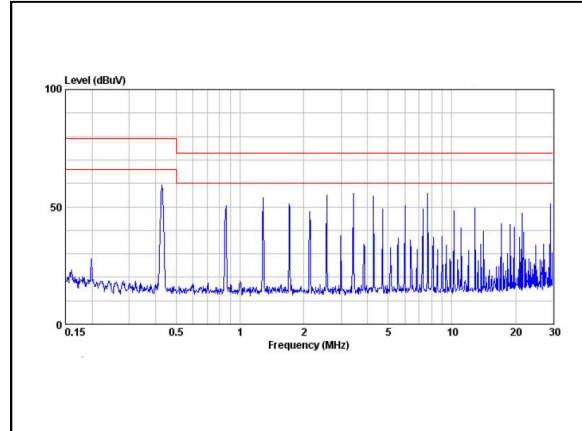

Figure 278: ATA00BB36S-L Conduction Emission of EN550122 Class A
Vin = 48Vdc, Load: Io = ±0.125A, Ta = 25 °C

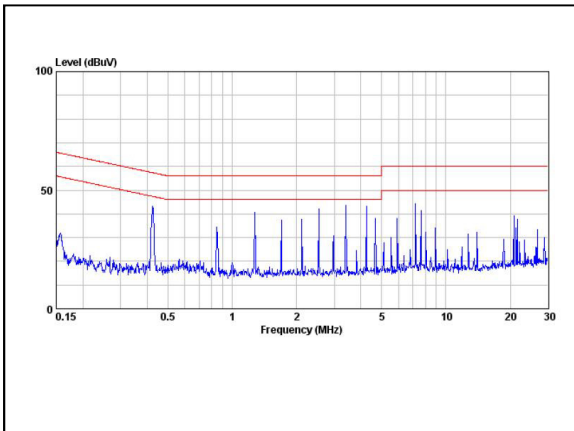

Figure 279: ATA00BB36S-L Conduction Emission of EN550122 Class B
Vin = 48Vdc, Load: Io = ±0.125A, Ta = 25 °C (with external filter)

ATA00CC36S-L Performance Curves

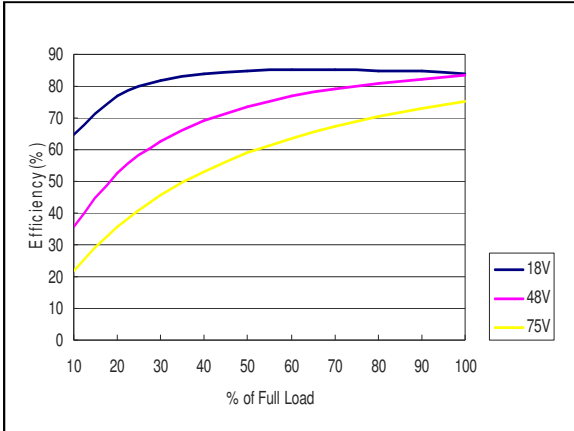

Figure 280: ATA00CC36S-L Efficiency Versus Output Current Curve
Vin = 18 to 75Vdc, Load: $i_o = 0$ to $\pm 0.1A$, Ta = 25 °C

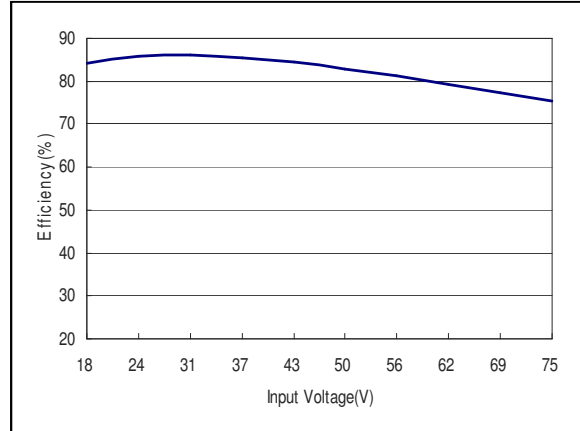

Figure 281: ATA00CC36S-L Efficiency Versus Input Voltage Curve
Vin = 18 to 75Vdc, Load: $i_o = \pm 0.1A$, Ta = 25 °C

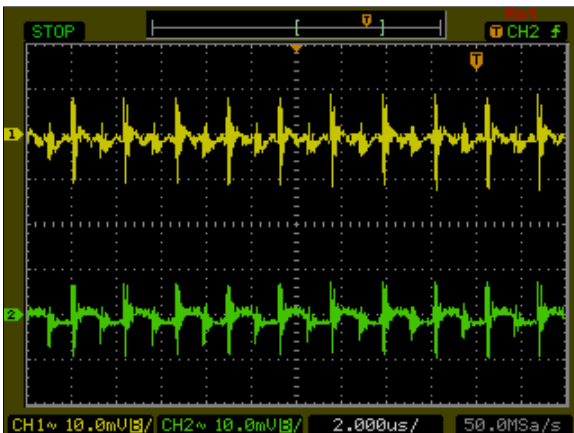

Figure 282: ATA00CC36S-L Ripple and Noise Measurement
Vin = 48Vdc, Load: $i_o = \pm 0.1A$, Ta = 25 °C
Ch 1: V1
Ch 2: V2

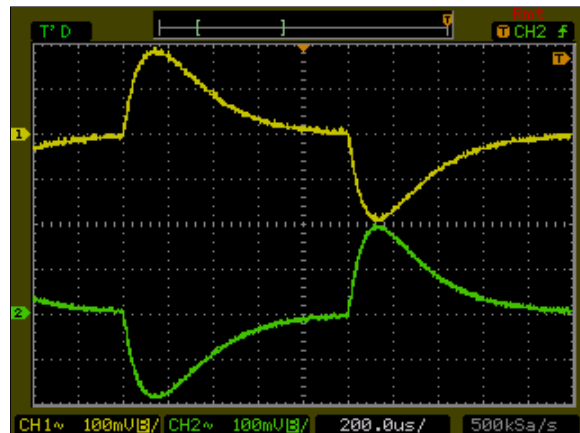

Figure 283: ATA00CC36S-L Transient Response
Vin = 48Vdc, Load: $i_o = 100\%$ to 75% load change, Ta = 25 °C
Ch 1: V1
Ch 2: V2

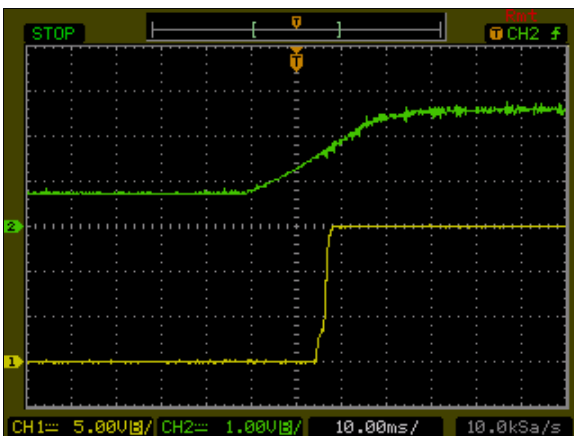

Figure 284: ATA00CC36S-L Output Voltage Startup Characteristic by Remote
Vin = 48Vdc, Load: $i_o = \pm 0.1A$, Ta = 25 °C
Ch1: V1
Ch2: Remote On/Off

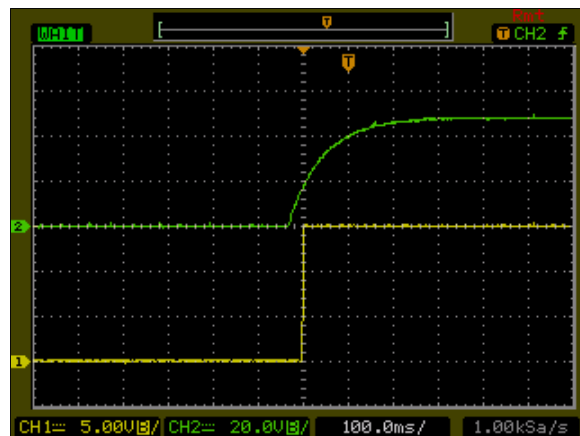

Figure 285: ATA00CC36S-L Output Voltage Startup Characteristic by Vin
Vin = 48Vdc, Load: $i_o = \pm 0.1A$, Ta = 25 °C
Ch1: V1
Ch2: Vin

ATA00CC36S-L Performance Curves

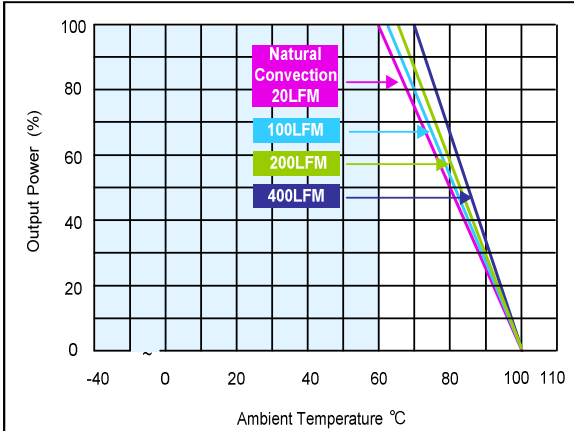

Figure 286: ATA00CC36S-L Derating Curves
Vin = 48Vdc, Load: Io = 0 to ±0.1A, Ta = 25 °C

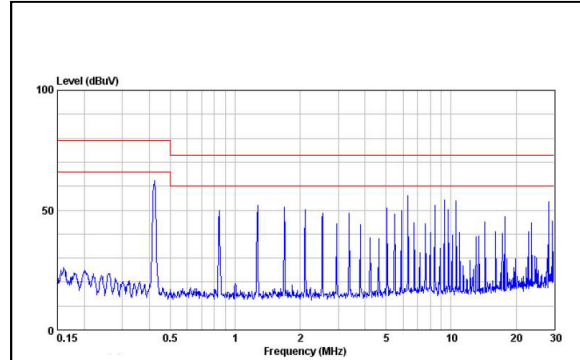

Figure 287: ATA00CC36S-L Conduction Emission of EN550122 Class A
Vin = 48Vdc, Load: Io = ±0.1A, Ta = 25 °C

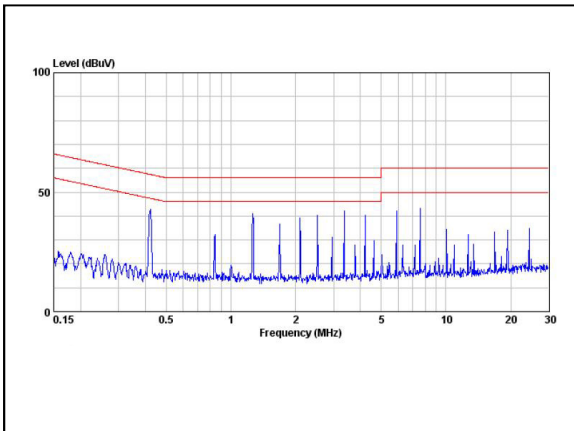
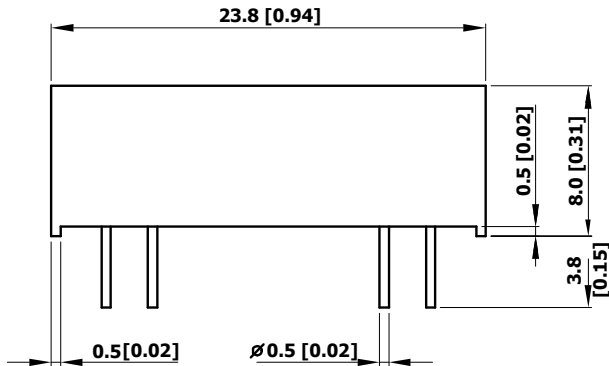

Figure 288: ATA00CC36S-L Conduction Emission of EN550122 Class B
Vin = 48Vdc, Load: Io = ±0.1A, Ta = 25 °C (with external filter)

Mechanical Specifications

Mechanical Outlines for Single & Dual DIP Module



Pin Connections

Single output

Pin 1	-	-Vin
Pin 2	-	Remote On/Off
Pin 7	-	NC
Pin 8	-	NC
Pin 9	-	+Vout
Pin 10	-	-Vout
Pin 16	-	+Vin

Dual Output

Pin 1	-	-Vin
Pin 2	-	Remote On/Off
Pin 7	-	NC
Pin 8	-	Common
Pin 9	-	+Vout
Pin 10	-	-Vout
Pin 16	-	+Vin

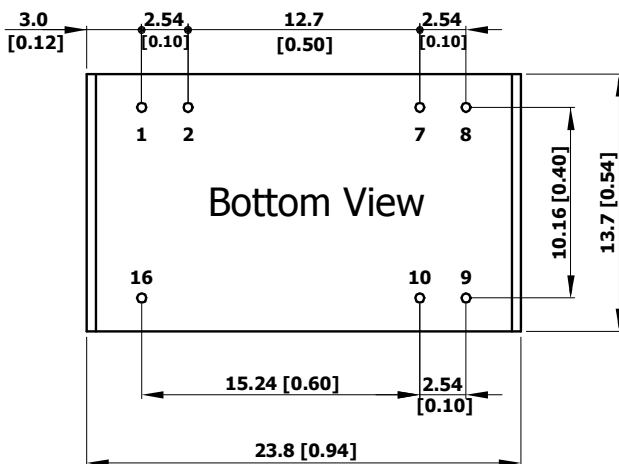

Note:

- All dimensions in mm (inches)
Tolerance: X.X±0.25mm (X.XX±0.01")
X.XX±0.13mm (X.XXX±0.005")
- Pin pitch tolerance: ±0.25mm (±0.01")
- Pin dimension tolerance: ±1.0mm (±0.004")
- Case Material: Non-Conductive Black Plastic (Flammability to UL 94V-0 rated)
- Pin Material: Phosphor bronze

Recommended Pad Layout for Single & Dual DIP Module

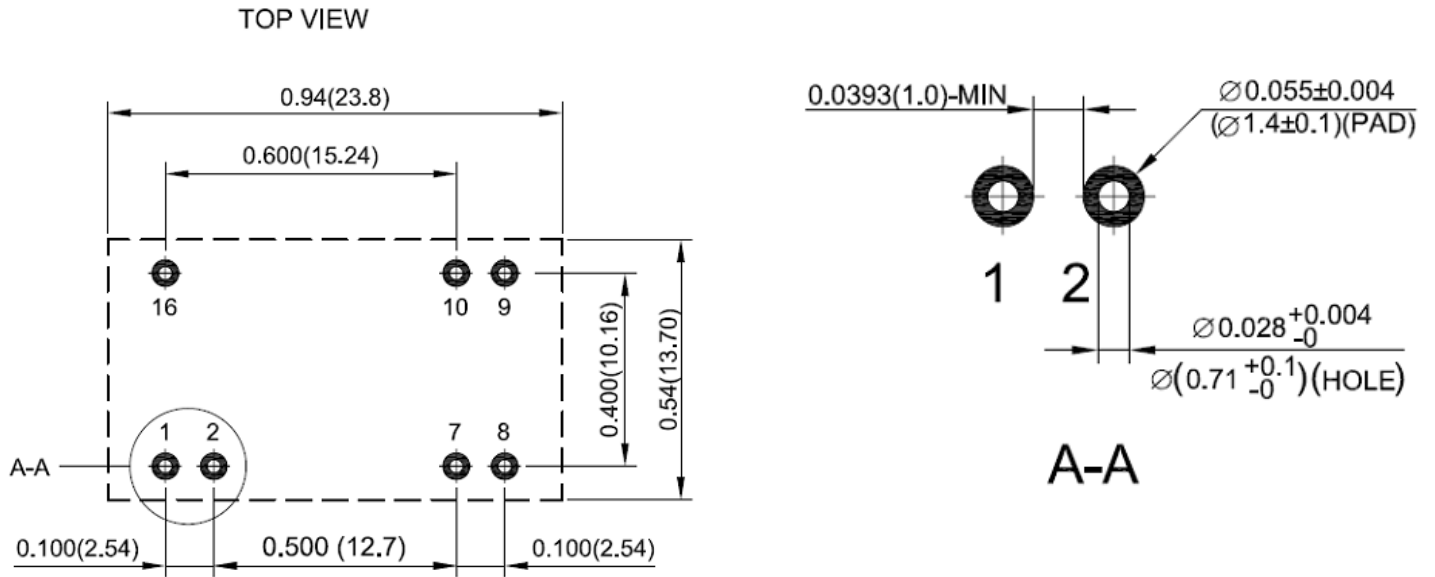

Note:

1. All dimensions in inches (mm)
Tolerance: X.XX ± 0.02" (X.X ± 0.5mm)
X.XXX ± 0.01" (X.XX ± 0.25mm)
2. Pin pitch tolerance: ± 0.01" (± 0.25mm)
3. Pin dimension tolerance: ± 0.004" (± 0.1mm)
4. Case Material: Non-Conductive Black Plastic (Flammability to UL 94V-0 rated)
5. Pin Material: Phosphor bronze

Mechanical Outlines for Single & Dual SMD Module

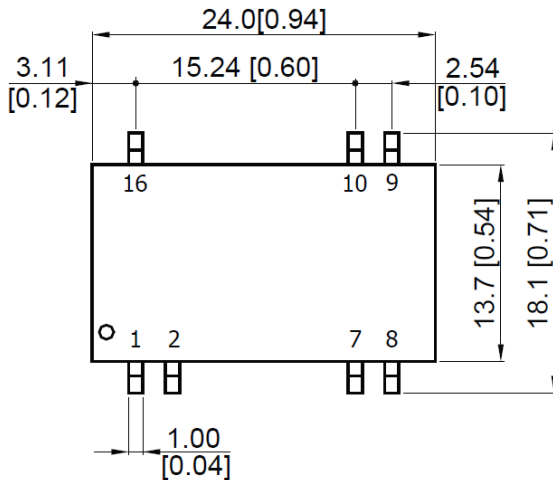

Pin Connections

Single output

Pin 1	-	-Vin
Pin 2	-	Remote On/Off
Pin 7	-	NC
Pin 8	-	NC
Pin 9	-	+Vout
Pin 10	-	-Vout
Pin 16	-	+Vin

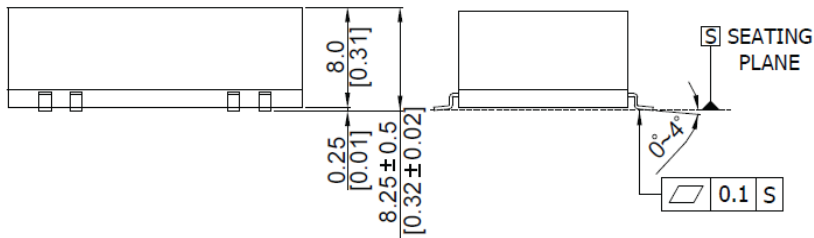

Dual Output

Pin 1	-	-Vin
Pin 2	-	Remote On/Off
Pin 7	-	NC
Pin 8	-	Common
Pin 9	-	+Vout
Pin 10	-	-Vout
Pin 16	-	+Vin

Note:

- All dimensions in mm (inches)
Tolerance: X.X±0.25mm (X.XX±0.01")
X.XX±0.13mm (X.XXX±0.005")
- Pin pitch tolerance: ±0.25mm (±0.01")
- Pin dimension tolerance: ±1.0mm (±0.004")
- Case Material: Non-Conductive Black Plastic (Flammability to UL 94V-0 rated)
- Pin Material: Phosphor bronze

Recommended Pad Layout for Single & Dual SMD Module

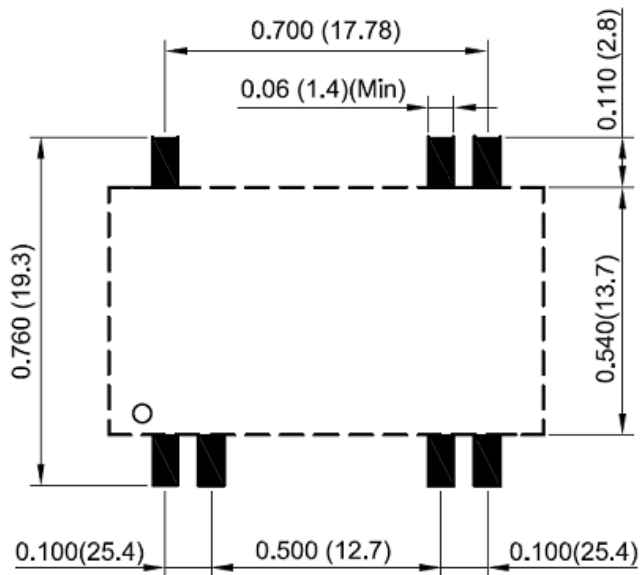

Note:

1. All dimensions in inches (mm)
Tolerance: X.XX±0.02" (X.X±0.5mm)
X.XXX±0.01" (X.XX±0.25mm)
2. Pin pitch tolerance: ±0.01" (±0.25mm)
3. Pin dimension tolerance: ±0.004" (±0.1mm)
4. Case Material: Non-Conductive Black Plastic (Flammability to UL 94V-0 rated)
5. Pin Material: Phosphor bronze

Weight

The ATA 3W series weight is 5.1g typical.

Environmental Specifications

EMC Immunity

ATA 3W series power supply is designed to meet the following EMC immunity specifications.

Table 4. EMC Specifications:

Parameter	Standards & Level	Performance
EMI	EN55022	Class A & Class B

EMC Considerations

EMI-Filter to meet EN 55022, class B, FCC part 15, level B

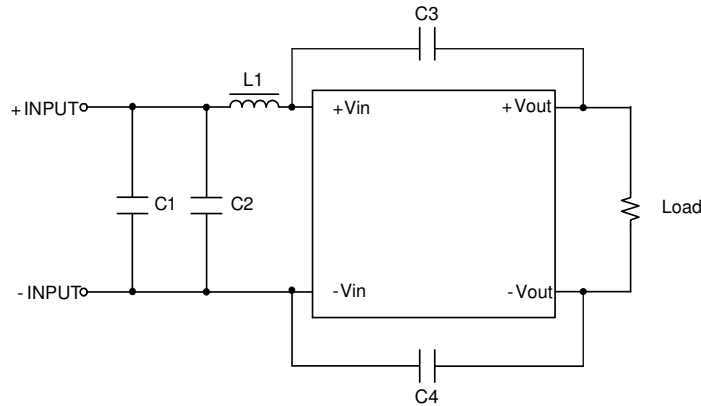

Recommended circuit to comply EN55022 Class B limits

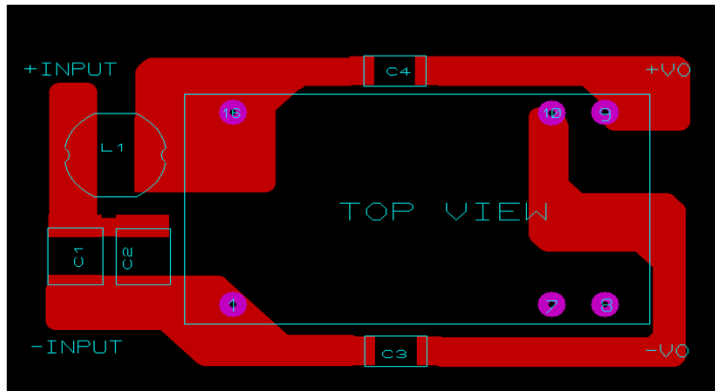

Recommended PCB Layout with Input Filter for DIP module

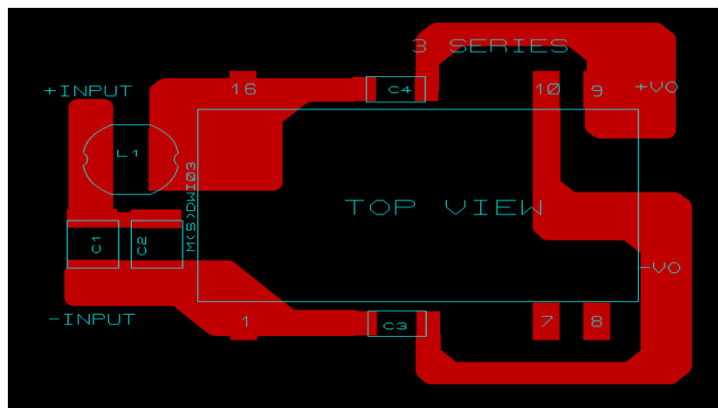

Recommended PCB Layout with Input Filter for SMD module

Table 5. To comply with EN55022 CLASS B following components are needed:

Model	Component	Value	Voltage	Reference
24V Input Module	C1&C2	10 μ F	50V	1812/Y5V
	C3&C4	470pF	2KV	1808/X7R
	L1	27 μ H		SCD0403T/0.71A
48V Input Module	C1&C2	1 μ F	100V	1812/Y5V
	C3&C4	2200pF	2KV	1808/X7R
	L1	88 μ H		SCD0403T/1.42A

Safety Certifications

The ATA 3W series power supply is intended for inclusion in other equipment and the installer must ensure that it is in compliance with all the requirements of the end application. This product is only for inclusion by professional installers within other equipment and must not be operated as a stand alone product.

Table 6. Safety Certifications for ATA 3W series power supply system:

Document	Description
cUL/UL 60950-1 (CSA certificate)	US and Canada Requirements
IEC/EN 60950-1 (CB-scheme)	European Requirements (All CENELEC Countries)

Safety and Installation Instruction

Fusing Consideration

Caution: This power module is not internally fused. An input line fuse must always be used.

This encapsulated power module can be used in a wide variety of applications, ranging from simple stand-alone operation to an integrated part of sophisticated power architecture. To maximum flexibility, internal fusing is not included; however, to achieve maximum safety and system protection, always use an input line fuse. The safety agencies require a normal-blow fuse in 24V_{in} with maximum rating of 700mA and in 48V_{in} with maximum rating of 350mA. Based on the information provided in this data sheet on Inrush energy and maximum dc input current; the same type of fuse with lower rating can be used. Refer to the fuse manufacturer's data for further information.

MTBF and Reliability

The MTBF of ATA 3W series of DC/DC converters has been calculated using MIL-HDBK 217F NOTICE2, Operating Temperature @25 °C, Ground Benign.

Model	MTBF	Unit
ATA00F18-L	934,667	Hours
ATA00A18-L	932,923	
ATA00B18-L	943,752	
ATA00C18-L	953,834	
ATA00H18-L	960,799	
ATA00AA18-L	931,446	
ATA00BB18-L	947,329	
ATA00CC18-L	947,329	
ATA00F36-L	934,667	
ATA00A36-L	937,295	
ATA00B36-L	943,752	
ATA00C36-L	951,203	
ATA00H36-L	958,405	
ATA00AA36-L	936,768	
ATA00BB36-L	949,127	
ATA00CC36-L	945,180	

Technical Reference Note

Rev.09.26.19_#1.0
ATA 3W Series
Page 87

Model	MTBF	Unit
ATA00F18S-L	839,842	Hours
ATA00A18S-L	837,942	
ATA00B18S-L	846,238	
ATA00C18S-L	854,847	
ATA00H18S-L	860,437	
ATA00AA18S-L	836,750	
ATA00BB18S-L	850,051	
ATA00CC18S-L	850,051	
ATA00F36S-L	839,842	
ATA00A36S-L	841,468	
ATA00B36S-L	846,668	
ATA00C36S-L	852,660	
ATA00H36S-L	858,516	
ATA00AA36S-L	841,538	
ATA00BB36S-L	851,499	
ATA00CC36S-L	848,320	

Application Notes

Input Reflected-Ripple Current Test Setup

Input reflected-ripple current is measured with an inductor L_{in} ($4.7\mu H$) and C_{in} ($220\mu F$, $ESR < 1.0\Omega$ at 100 KHz) to simulate source impedance. Capacitor C_{in} , offsets possible battery impedance. Current ripple is measured at the input terminals of the module, measurement bandwidth is $0\text{-}500\text{ KHz}$.

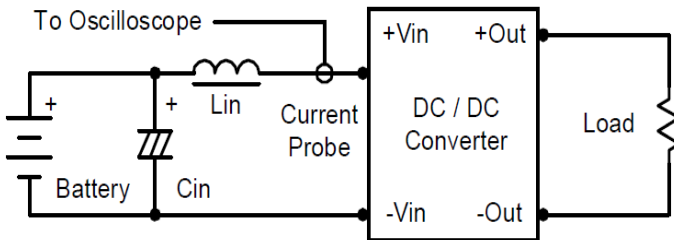

Component	Value	Reference
Lin	$4.7\mu H$	-
Cin	$220\mu F$ ($ESR < 1.0\Omega$ at 100 KHz)	Aluminum Electrolytic Capacitor

Output Ripple Reduction

A good quality low ESR capacitor placed as close as practicable across the load will give the best ripple and noise performance. To reduce output ripple, it is recommended to use 3.3uF capacitors at the output.

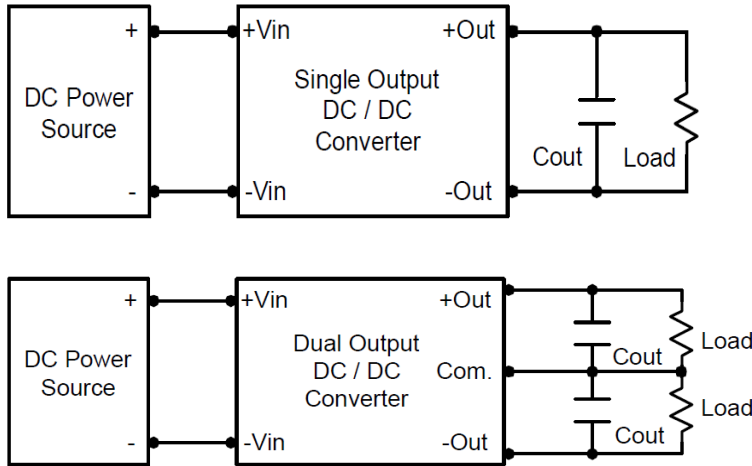

Peak-to-Peak Output Noise Measurement Test

Use a Cout 0.47uF ceramic capacitor. Scope measurement should be made by using a BNC socket, measurement bandwidth is 0-20MHz. Position the load between 50 mm and 75 mm from the DC/DC Converter

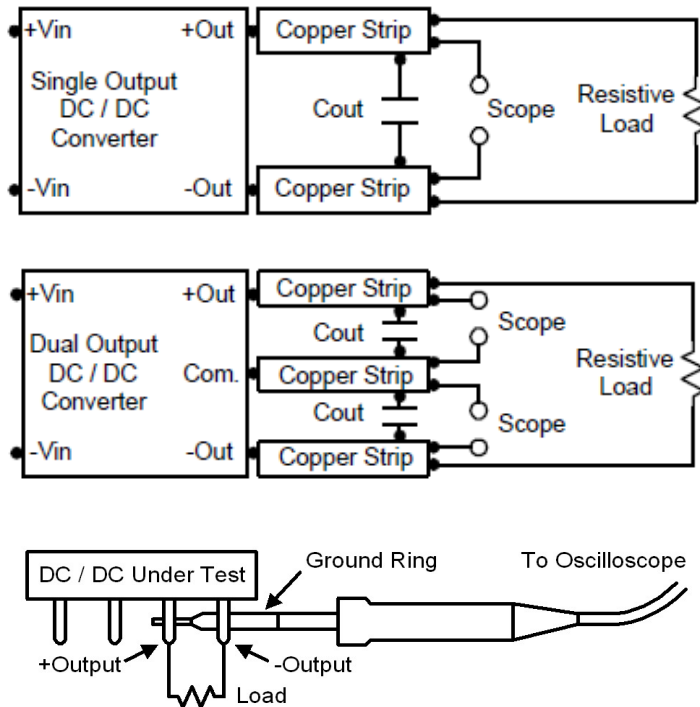

Input Source Impedance

The power module should be connected to a low ac-impedance input source. Highly inductive source impedances can affect the stability of the power module.

In applications where power is supplied over long lines and output loading is high, it may be necessary to use a capacitor at the input to ensure startup.

Capacitor mounted close to the power module helps ensure stability of the unit, it is recommended to use a good quality low Equivalent Series Resistance ($ESR < 1.0\Omega$ at 100 KHz) capacitor of a 4.7 μ F for the 24V and a 2.2 μ F for the 48V devices.

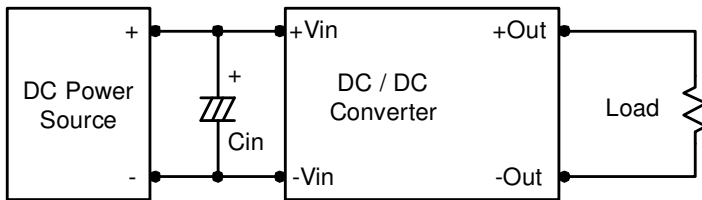

Output Over Current Protection

To provide protection in a fault (output overload) condition, the unit is equipped with internal current limiting circuit and can endure current limiting for an unlimited duration. At the point of current-limit inception, the unit shifts from voltage control to current control. The unit operates normally once the output is brought back into its specified range

Thermal Considerations

Many conditions affect the thermal performance of the power module, such as orientation, airflow over the module and board spacing. To avoid exceeding the maximum temperature rating of the components inside the power module, the case temperature must be kept below 105 °C. The derating curves are determined from measurements obtained in a test setup.

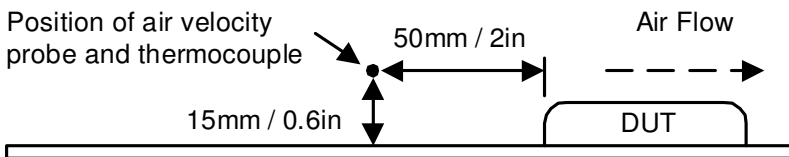

Maximum Capacitive Load

The ATA 3W series has limitation of maximum connected capacitance at the output. The power module may be operated in current limiting mode during start-up, affecting the ramp-up and the startup time. The maximum capacitance can be found in the Table 3.

Output voltage and efficiency measurement test setup

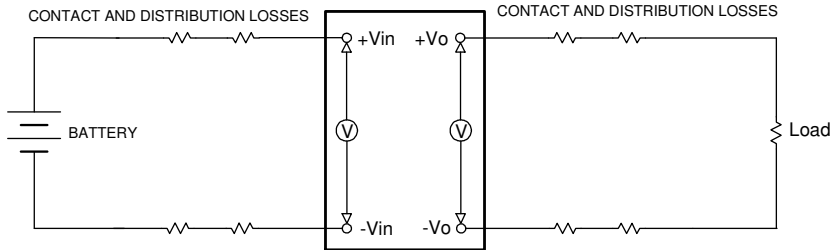

$$Efficiency = \left(\frac{V_{out} \times I_{out}}{V_{in} \times I_{in}} \right) \times 100\%$$

Short Circuitry Protection

Continuous and auto-recovery mode.

During short circuit, converter still shut down, The average current during this condition will be very low and the device will be safe in this condition.

Remote ON/OFF Control

The positive logic remote ON/OFF control circuit is included.

Turns the module ON during logic High on the ON/Off pin and turns OFF during logic Low. The ON/OFF input signal (Von/off) that referenced to GND. If not using the remote on/off feature, please open circuit between on/off pin and -Vin pin to turn the module on.

The negative logic remote ON/OFF control circuit is included.

Turns the module ON during logic Low on the On/Off pin and turns OFF during logic High. The On/Off pin is an open collector/drain logic input signal (Von/off) that referenced to GND. If not using the remote on/off feature. Please short circuit between on/off pin and -Vin pin to turn the module on.

Remote ON/OFF implementation,

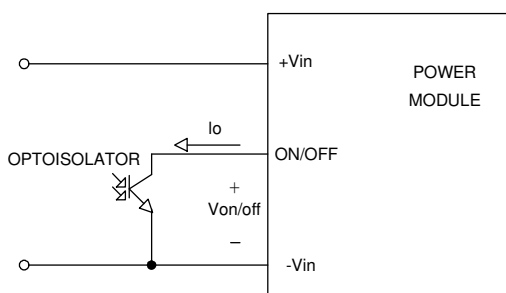

Isolated-Closure Remote ON/OFF

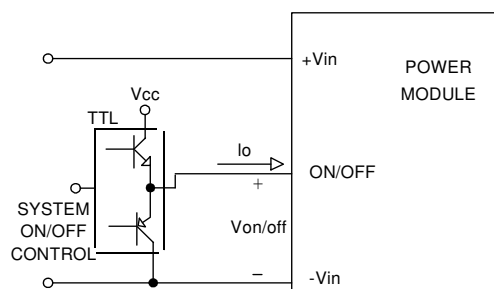

Level Control Using TTL Output

Packaging Information

For the DIP module

TUBE

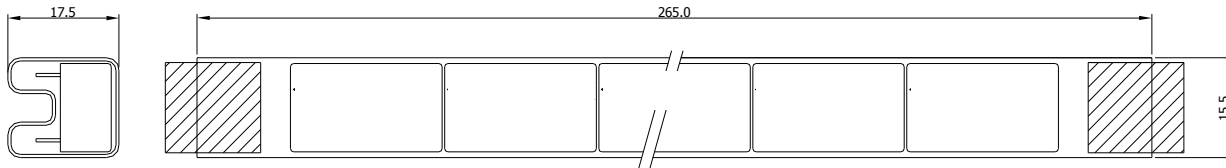

unit:mm

10 PCS per TUBE

For the SMD module

TUBE

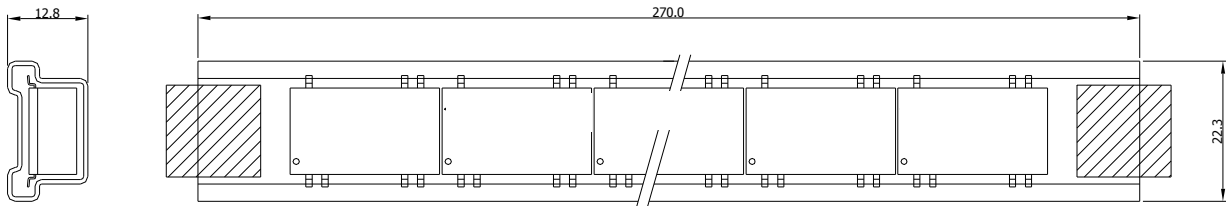

unit:mm

10 PCS per TUBE

Soldering and Reflow Considerations

Lead free wave solder profile for DIP module

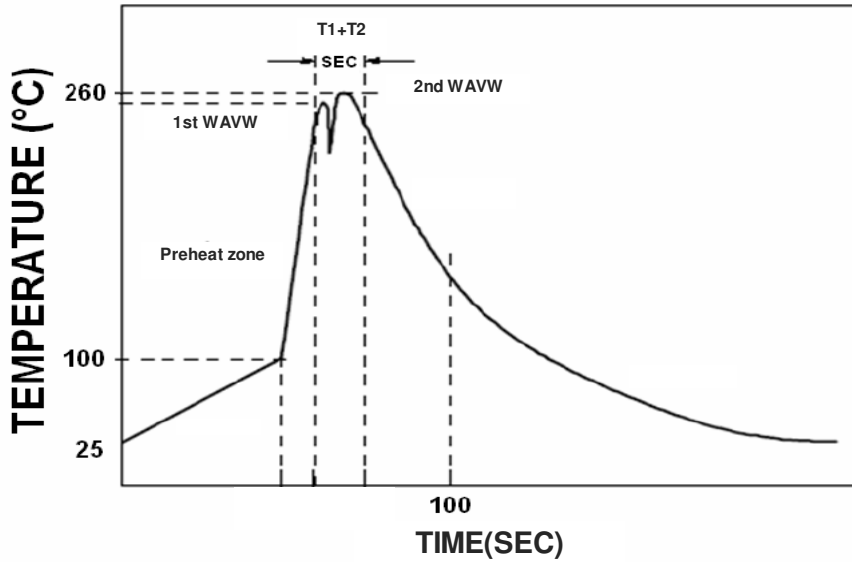

Zone	Reference Parameter
Preheat zone	Rise temp speed : 3°C/sec max.
	Preheat temp : 100~130°C
Actual heating	Peak temp: 250~260°C Peak Time
	Peak time(T1+T2): 4~6 sec

Reference Solder: Sn-Ag-Cu: Sn-Cu: Sn-Ag
Hand Welding: Soldering iron: Power 60W
Welding Time: 2~4 sec
Temp.: 380~400°C

Lead free wave solder profile for SMD module

Profile Feature ^{1,2}	Sn-Pb Eutectic Assembly	Pb-Free Assembly
Average ramp-up rate (T_{smax} to T_p)	3°C/second max.	3°C/second max.
Preheat - Temperature Min (T_{smin}) - Temperature Max (T_{smax}) - Time (T_{smin} to T_{smax}) (ts)	100°C 150°C 60-120 seconds	150°C 200°C 60-180 seconds
Peak Temperature(T_p)	See Table 7-1	See Table 7-2
Time maintained above: - Temperature (T_L) - Time (T_L)	183°C 60-150 seconds	217°C 60-150 seconds
Time within 5°C of actual peak Temperature (tp) ²	10-30 seconds	20-40 seconds
Ramp-down Rate	6°C/second max.	6°C/second max.
Time 25°C to Peak Temperature	6 minutes max.	8 minutes max.

Note 1 – All temperatures refer to topside of the package, measured on the package body surface.

Note 2 – Time within 5°C of actual peak temperature (tp) specified for the reflow profiles is a 'supplier' minimum and 'user' maximum.

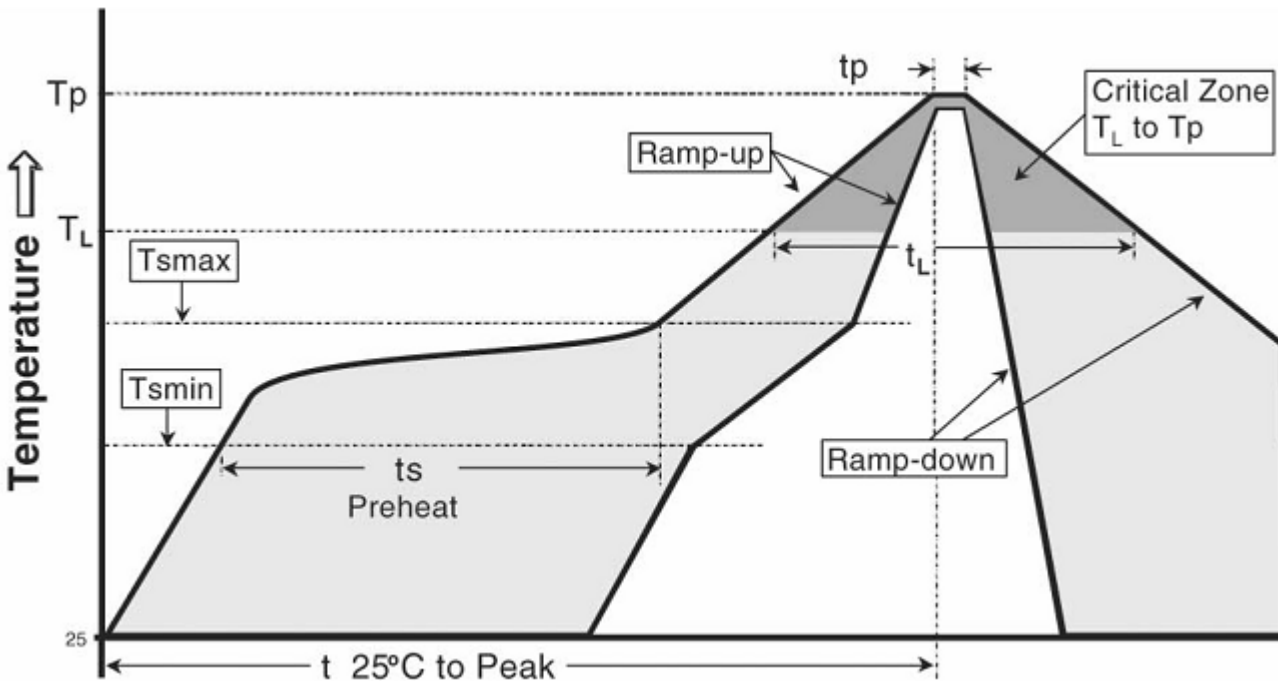

Table 7-1. Sn-Pb Eutectic Process-Classification Temperatures (T_C):

Package Thickness	Volume mm ³ <350	□ Volume mm ³ 350
<2.5mm	235°C	220°C
□2.5mm	220°C	220°C

Table 7-2. Pb-Free Process-Classification Temperatures (T_C):

Package Thickness	Volume mm ³ <350	Volume mm ³ 350-2000	Volume mm ³ >2000
<1.6mm	260°C	260°C	260°C
1.6mm-2.5mm	260°C	250°C	245°C
>2.5mm	250°C	245°C	245°C

WORLDWIDE OFFICES

Americas

2900 South Diablo Way
Suite B100
Tempe, AZ 85282
USA
+1 888 412 7832

Europe (UK)

Ground Floor Offices
Barberry House, 4 Harbour Buildings
Waterfront West, Brierley Hill
West Midlands, DY5 1LN, UK
+44 (0) 1384 842 211

Asia (HK)

14/F, Lu Plaza
2 Wing Yip Street
Kwun Tong, Kowloon
Hong Kong
+852 2176 3333

ARTESYNTM
An Advanced Energy Company
www.artesyn.com

For more information: www.artesyn.com
For support: productsupport.ep@artesyn.com

Artesyn Embedded Technologies, Artesyn Embedded Power, Artesyn, and all Artesyn related logos are trademarks and service marks of Artesyn Embedded Technologies, Inc. All other names and logos referred to are trade names, trademarks, or registered trademarks of their respective owners. Specifications are subject to change without notice. © 2019 Artesyn Embedded Technologies, Inc. All rights reserved. For full legal terms and conditions, please visit www.artesyn.com/legal.