

SL POWER NGB800 SERIES

800 Watts Single Output
Medical / Industrial Grade



Medical



Industrial

PRODUCT DESCRIPTION

Advanced Energy’s SL Power NGB800 series of open-frame AC-DC power supplies features ITE and medical safety approvals. The series offers a choice of four single output models, with voltages of 12V, 15V, 24V, or 48V. Each model also provides an isolated 12V fan output, and 5V standby output. NGB800 series power supplies provide 800Watts of output power, and have a typical full load power conversion efficiency of 90%. All models have output overvoltage, short circuit and overload protection and a 5 x 8 x 1.6 inch form factor.

AT A GLANCE

Total Power

800 Watts

Input Voltage

80 to 264 Vac

of Outputs

Single



SPECIAL FEATURES

- Up to 800W with Air Flow
- Up to 550W Convection Cooled
- 5" X 8" X 1.6" Size
- Universal Input 80 to 264Vac
- Meets Class B Emissions Levels
- 7+ Years Electrolytic Capacitor Life
- -20°C to 70°C Operating Temperature Range
- Meets 4th Edition/Heavy Industrial EMC
- Less than 100uA Leakage Current
- 3 Years Warranty
- ROHS Compliant
- REACH Compliant

SAFETY

- UL/CSA/IEC/EN 60601-1 Am1, BF Rated
- UL/CSA/IEC/EN 62368-1 Am1
- CE Compliance

TYPICAL APPLICATIONS

- ITE
- Medical

MODEL NUMBERS

Standard	Output Voltage	With Air Flow		Convection		Conduction	
		Output Current	Output Power	Output Current	Output Power	Output Current	Output Power
NGB800S12K	12V	57.5A	690W	39.0A	468W	44.8A	538W
NGB800S15K	15V	46.0A	690W	26.7A	400W	35.9A	538W
NGB800S24K	24V	33.3A	800W	22.9A	550W	26.3A	632W
NGB800S48K	48V	16.7A	800W	11.4A	550W	13.2A	632W

Options

None

ELECTRICAL SPECIFICATIONS

Absolute Maximum Ratings

Stress in excess of those listed in the “Absolute Maximum Ratings” may cause permanent damage to the power supply. These are stress ratings only and functional operation of the unit is not implied at these or any other conditions above those given in the operational sections of this TRN. Exposure to any absolute maximum rated condition for extended periods may adversely affect the power supply’s reliability.

Table 1. Absolute Maximum Ratings						
Parameter	Model	Symbol	Min	Typ	Max	Unit
Input Voltage AC continuous operation	All models	$V_{IN,AC}$	80	-	264	Vac
Maximum Output Power (convection)	NGB800S12 NGB800S15 NGB800S24 NGB800S48	$P_{O,maxCC}$	- - - -	- - - -	468 400 550 550	W
Maximum Output Power (conduction)	NGB800S12 NGB800S15 NGB800S24 NGB800S48		- - - -	- - - -	538 538 632 632	W
Maximum Output Power (forced air - 300LFM)	NGB800S12 NGB800S15 NGB800S24 NGB800S48	$P_{O,maxFA}$	- - - -	- - - -	690 690 800 800	W
Isolation Voltage Input to output Input to ground Outputs to ground	All Models All Models All Models		- - -	- - -	4500 1500 1500	Vac Vac Vdc
Ambient Operating Temperature	All Models	T_A	-20	-	+70 ¹	°C
Storage Temperature	All Models	T_{STG}	-40	-	+85	°C
Humidity (non-condensing)	All Models		5	-	95	%
Altitude Operating Non-operating	All Models All Models		-500 -500	- -	5,000 12,192	m m

Note 1 - PSU performance derate above 50°C to 70°C, and from 0°C to -20°C.

ELECTRICAL SPECIFICATIONS

Input Specifications

Table 2. Input Specifications						
Parameter	Condition	Symbol	Min	Typ	Max	Unit
Operating Input Voltage, AC	All	$V_{IN,AC}$	80	115/230	264	Vac
Input AC Frequency	All	$f_{IN,AC}$	47	50/60	63	Hz
Maximum Steady State Input Current ($I_O = I_{O,max}$, $I_{SB} = I_{SB,max}$)	$V_{IN,AC} = 115Vac$ $V_{IN,AC} = 230Vac$	$I_{IN,max}$	- -	- -	8 4	A
Standby Input Power (V_O Off, $I_{SB} = 0$, $I_{FAN} = 0$)	$V_{IN,AC} = 115/230Vac$	$I_{IN,no-load}$	-	-	0.5	W
Startup Surge Current (Inrush)	Cold start	$I_{IN,surge}$	-	-	40	A
Input Fuse	Internal, L and N 250Vac		-	-	12	A
Switching Frequency	All	$f_{SW,PFC}$	-	115	-	kHz
Operating Efficiency @ 25°C	$I_O = I_{O,max}$ $V_{IN,AC} = 115/230Vac$	η	90	-	-	%
Hold Up Time	$V_{IN,AC} = 100Vac$ $P_O = 80\%P_{O,maxFA}$	$t_{Hold-Up}$	20	-	-	ms
Turn On Delay	$V_{IN,AC} = 115Vac$ $P_O = P_{O,maxFA}$	$t_{Turn-On}$	100	-	1000	ms
Leakage Current (Input to Earth)	$V_{IN,AC} = 264Vac$ $f_{IN,AC} = 60$ Hz NC	$I_{IN,leakage}$	-	-	500	μA
Leakage Current (Output to Earth)	$V_{IN,AC} = 264Vac$ $f_{IN,AC} = 60$ Hz NC/SFC	$I_{IN,leakage}$	-	-	100/500	μA
Harmonic Line Currents	All	THD	Per EN61000-3-2			

ELECTRICAL SPECIFICATIONS

Output Specifications

Table 3. Output Specifications								
Parameter	Condition		Symbol	Min	Typ	Max	Unit	
Factory Set Point Tolerance @ 25°C	$V_{IN,AC} = 115Vac$ $I_O = 50\%$ of $I_{O,max}$		$\pm\%V_O$	-	± 1	-	%	
Line Regulation	All		$\pm\%V_O$	-	-	1	%	
Load Regulation	All		$\pm\%V_O$	-	-	2	%	
Total Regulation	Inclusive of set point, line, load temperature change, warm-up drift and cross regulation		$\pm\%V_O$	-	-	5	%	
Output Adjust Range	All		$\pm\%V_O$	-	-	5	%	
Output Voltage	NGB800S12 NGB800S15 NGB800S24 NGB800S48	All	V_O	-	12.0	-	V	
	All models		V_{SB}	-	5.0	-		V
	All models		V_{FAN}	-	12.0	-		V
Convection Output Current	NGB800S12 NGB800S15 NGB800S24 NGB800S48	Convection cooling	I_O	0	-	39.0	A	
	All models		I_{SB}	0	-	2.0		A
	All models		I_{FAN}	0	-	1.0		A
Convection Output Power	NGB800S12 NGB800S15 NGB800S24 NGB800S48	Convection cooling	P_O	-	-	468 400 550 550	W	
Conduction Output Current	NGB800S12 NGB800S15 NGB800S24 NGB800S48	Conduction cooling	I_O	0	-	44.8 35.9 26.3 13.2	A	
	All models		I_{SB}	0	-	2.0		A
	All models		I_{FAN}	0	-	1.0		A
Conduction Output Power	NGB800S12 NGB800S15 NGB800S24 NGB800S48	Conduction cooling	P_O	-	-	538 538 632 632	W	
Force Air Output Current	NGB800S12 NGB800S15 NGB800S24 NGB800S48	300 LFM forced air cooling	I_O	0	-	57.5 46.0 33.3 16.7	A	
	All models		I_{SB}	0	-	2.0		A
	All models		I_{FAN}	0	-	1.0		A

ELECTRICAL SPECIFICATIONS

Output Specifications

Table 3. Output Specifications Con't							
Parameter		Condition	Symbol	Min	Typ	Max	Unit
Force Air Output Power	NGB800S12	300 LFM forced air cooling	P_O	-	-	690	W
	NGB800S15			-	-	690	
	NGB800S24			-	-	800	
	NGB800S48			-	-	800	
Load Capacitance		Startup		-	-	1000	μ F
V_O Dynamic Response Peak Deviation		50% (25% to 100% of $I_{O,max}$) load change Slew rate = 0.2A/ μ s	$\pm\%V_O$	-	-	3.5	%
V_O Turn On Overshoot		All	$\pm\%V_O$	-	-	3	%
V_O Turn Off Overshoot		All	$\pm\%V_O$	-	-	1	%
Output Ripple, pk-pk		Measure with a 0.1 μ F ceramic capacitor in parallel with a 10 μ F tantalum capacitor, 0 to 20MHz bandwidth	$\pm\%V_O$	-	-	1	%
V_O Over Voltage Protection		Latch off $I_O < 50\% I_{O,max}$	$\%V_O$	105	-	140	%
V_O Over Current Protection		All	$\%I_O$	130	-	200	%
Over Temperature Protection		All		Auto Recovery			
Short Circuit Protection		All		Hiccup Mode, Auto Recovery			

Note - Unless otherwise noted, all parameters are specified at nominal input (115/230Vac), 25°C ambient operating temperature, no load to full rated output power, and nominal output voltage.

ELECTRICAL SPECIFICATIONS

System Timing Specifications

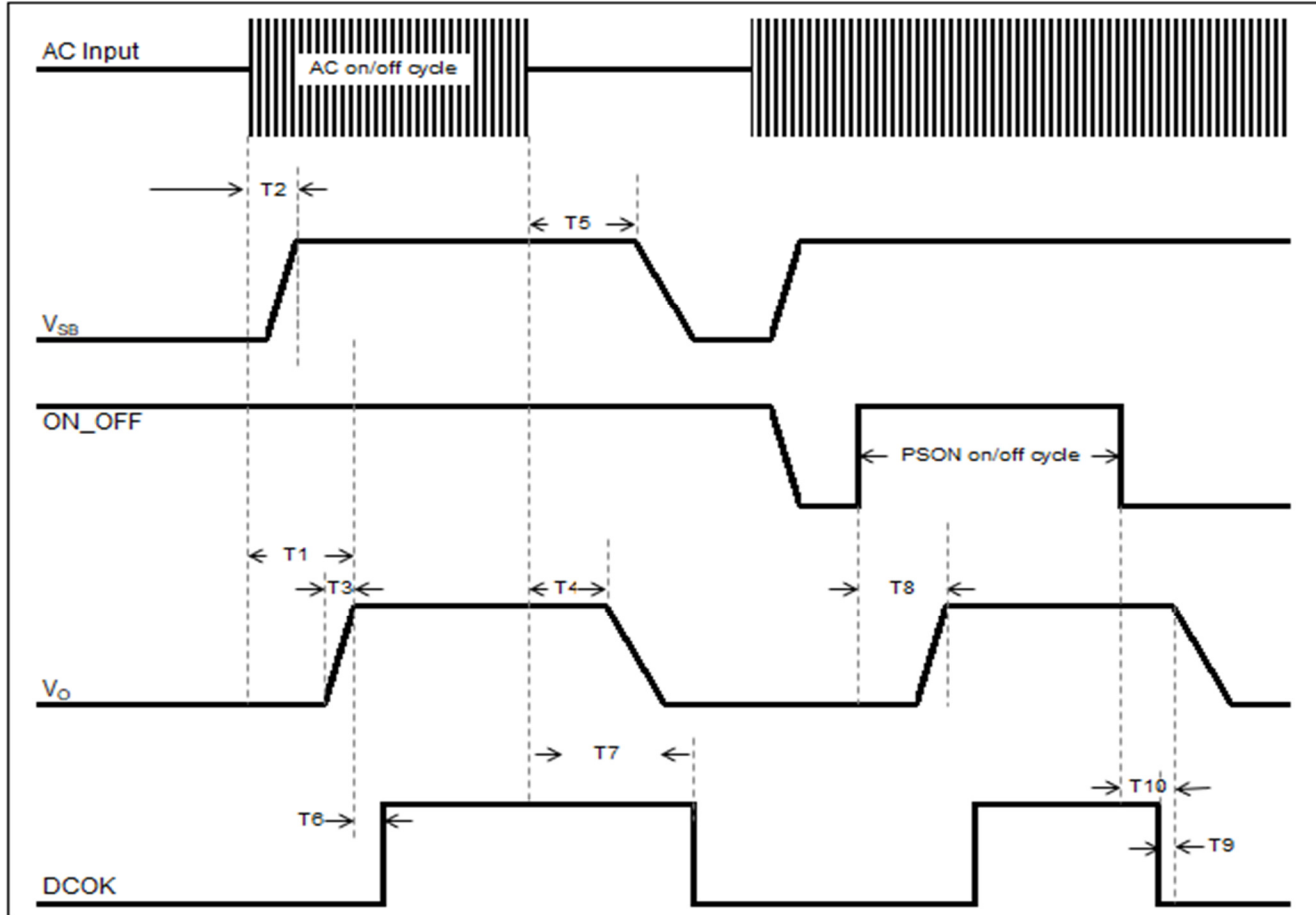

Label	Parameter	Min	Typ	Max	Unit
T1	Turn-On Time - Main outputs (115Vac, full Load).	100	-	1000	ms
T2	Turn-On Time - V _{SB} output.	-	-	100	ms
T3	Rise Time, 10% V _{main} to V _{main} in regulation.	-	-	100	ms
T4	Hold up time - All outputs stay within regulation after loss of AC. (Measured at 80% of P _{out} from 100Vac and V _{out} reduces to 90% of original value before the AC drop out.)	20	-	-	ms
T5	Hold up time - V _{SB} stays within regulation after loss of AC.	100	-	-	ms
T6	Delay from output voltages within regulation limits to DCOK asserted at turn on.	-	133	-	ms
T7	Delay from loss of AC to de-assertion of DCOK (1A load).	-	12	-	s
T8	Delay from ON_OFF active to output voltage within regulation limits.	-	257	-	ms
T9	Delay from DCOK de-asserted to output voltages out of regulation limits (in remote on/off cycle).	-	12	-	ms
T10	Delay from ON_OFF deactive to output voltage out of regulation.	-	54	-	ms

ELECTRICAL SPECIFICATIONS

NGB800S12K Performance Curves

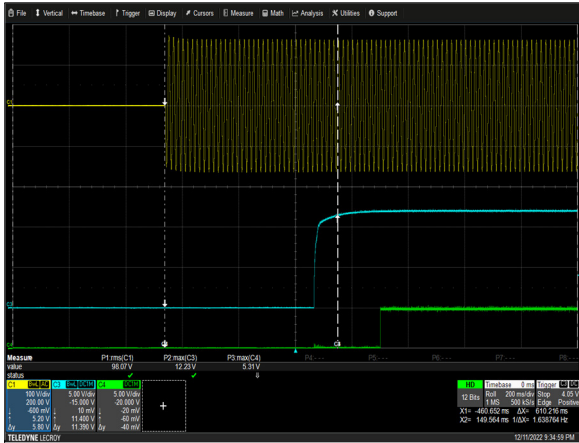

Figure 1: NGB800S12K Turn-on Delay
 Vin = 115Vac Load: Io = 57.5A
 Ch 1: VIN Ch 3: Vo Ch 4: DCOCK

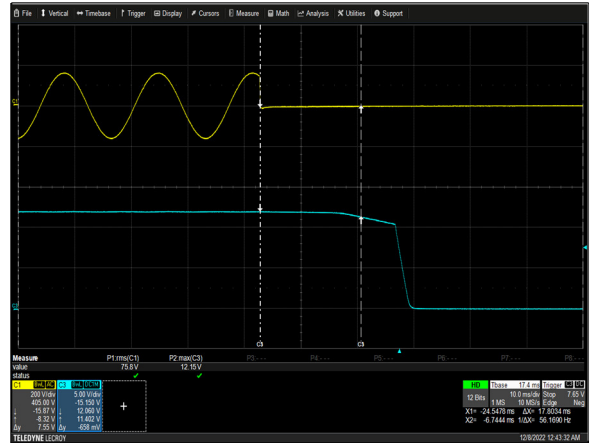

Figure 2: NGB800S12K Hold-up Time
 Vin = 115Vac Load: Io = 57.5A
 Ch 1: VIN Ch 3: Vo

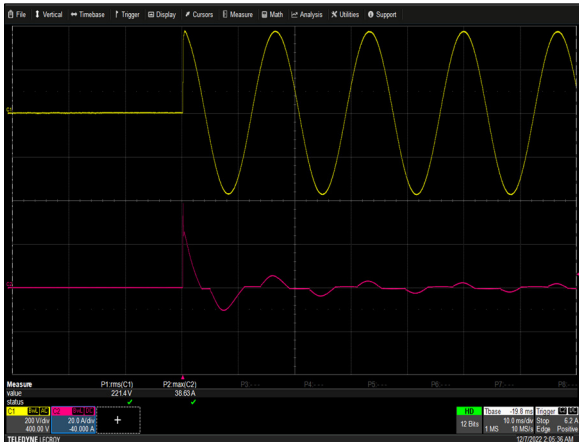

Figure 3: NGB800S12K Inrush Current
 Vin = 264Vac Load: Io = 0A, Turn on at 90 deg
 Ch 1: VIN Ch 2: IIN

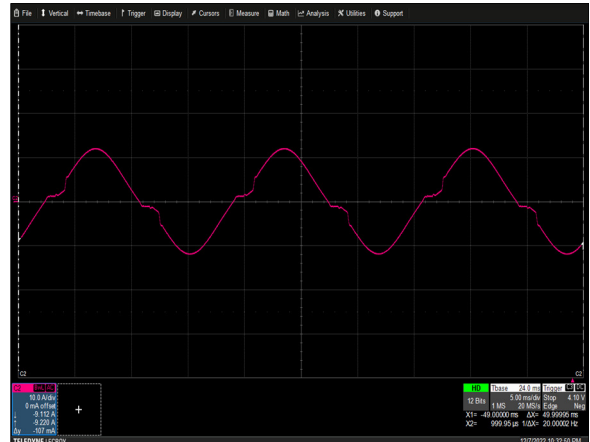

Figure 4: NGB800S12K Input Current Waveform
 Vin = 115Vac Load: Io = 57.5A
 Ch 2: IIN

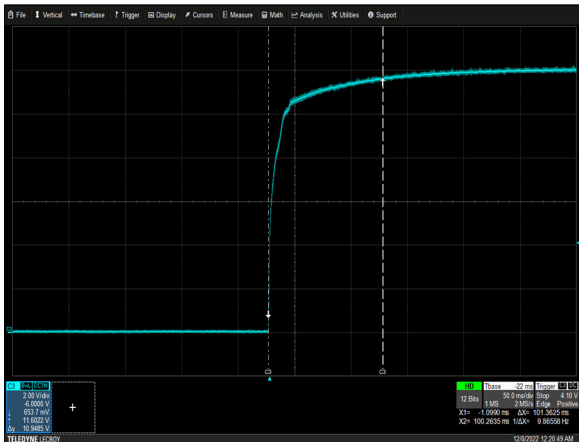

Figure 5: NGB800S12K Output Voltage Startup Characteristic
 Vin = 115Vac Load: Io = 57.5A
 Ch 3: Vo



Figure 6: NGB800S12K Ripple and Noise Measurement
 Vin = 115Vac Load: Io = 57.5A
 Ch 3: Vo

ELECTRICAL SPECIFICATIONS

NGB800S12K Performance Curves

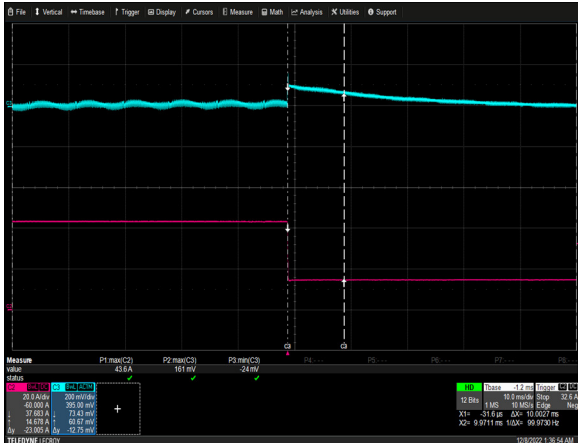

Figure 7: NGB800S12K Transient Response - Vo Deviation
 Vin = 115Vac Load: Io = 75% to 25%, 0.2A/μs slew rate
 Ch 2: Io Ch 3: Vo

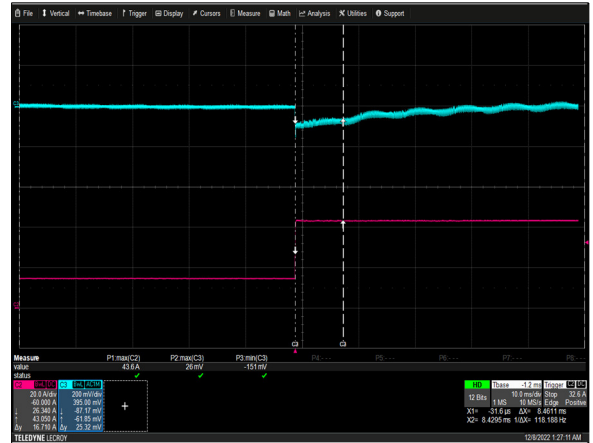

Figure 8: NGB800S12K Transient Response - Vo Deviation
 Vin = 115Vac Load: Io = 25% to 75%, 0.2A/μs slew rate
 Ch 2: Io Ch 3: Vo

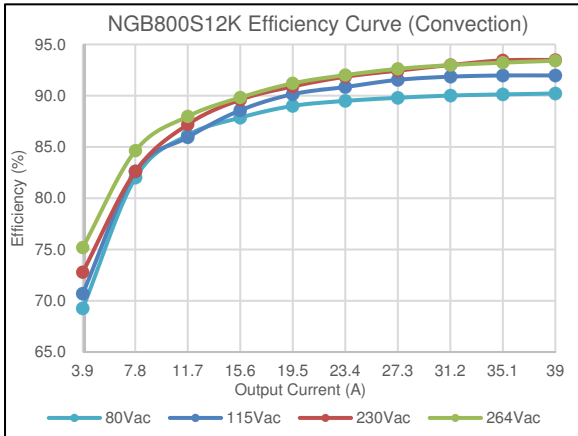

Figure 9: NGB800S12K Efficiency Curve @ 25°C (Convection)
 Loading: Io_main = 10%Io_max increment to Io_max

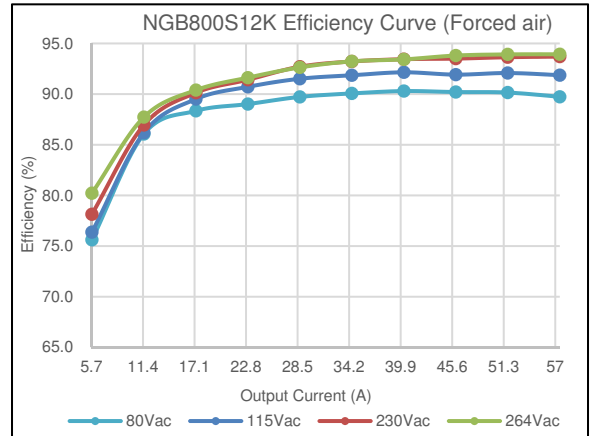

Figure 10: NGB800S12K Efficiency Curve @ 25°C (Forced air)
 Loading: Io_main = 10%Io_max increment to Io_max

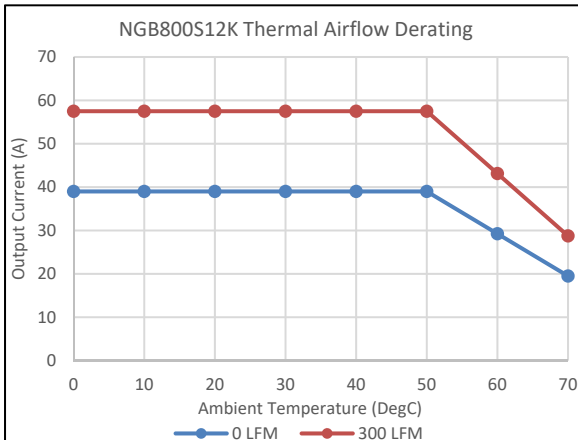

Figure 11: NGB800S12K Derating Curves
 Vin = 115Vac

ELECTRICAL SPECIFICATIONS

NGB800S24K Performance Curves

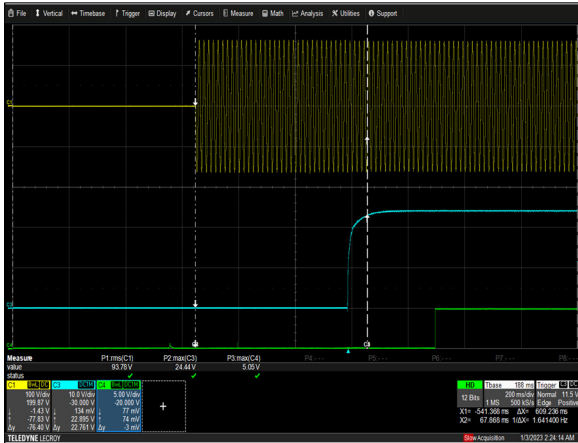

Figure 12: NGB800S24K Turn-on Delay
 Vin = 115Vac Load: Io = 33.3A
 Ch 1: V_{IN} Ch 3: V_o Ch 4: DCO

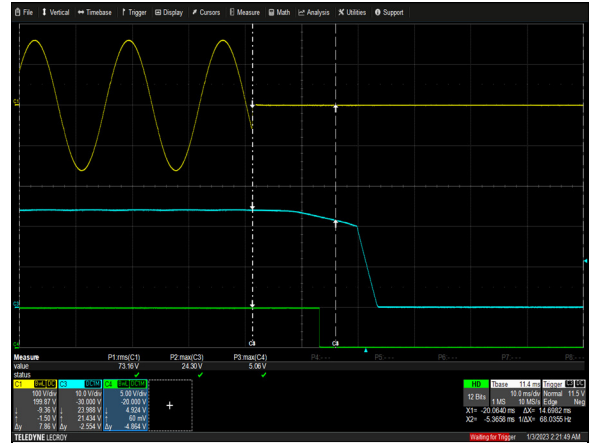

Figure 13: NGB800S24K Hold-up Time
 Vin = 115Vac Load: Io = 33.3A
 Ch 1: V_{IN} Ch 3: V_o Ch 4: DCO



Figure 14: NGB800S24K Inrush Current
 Vin = 264Vac Load: Io = 0A, Turn on at 90 deg
 Ch 1: V_{IN} Ch 2: I_{IN}

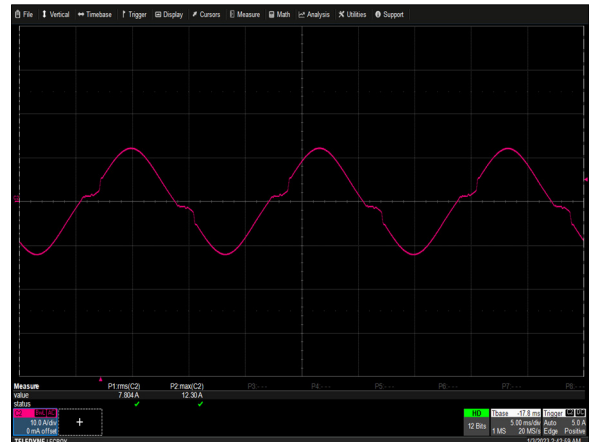

Figure 15: NGB800S24K Input Current Waveform
 Vin = 115Vac Load: Io = 33.3A
 Ch 2: I_{IN}

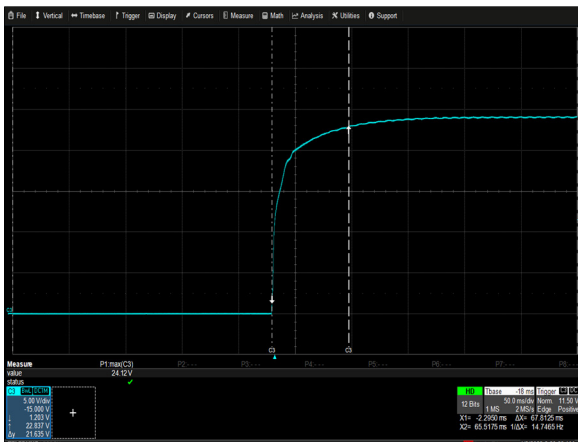

Figure 16: NGB800S24K Output Voltage Startup Characteristic
 Vin = 115Vac Load: Io = 33.3A
 Ch 3: V_o

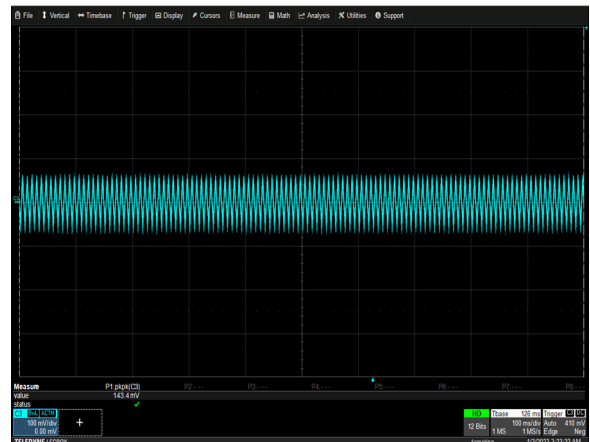

Figure 17: NGB800S24K Ripple and Noise Measurement
 Vin = 115Vac Load: Io = 33.3A
 Ch 3: V_o

ELECTRICAL SPECIFICATIONS



Figure 18: NGB800S24K Transient Response - Vo Deviation
 Vin = 115Vac Load: Io = 75% to 25%, 0.2A/ μ s slew rate
 Ch 2: Io Ch 3: Vo



Figure 19: NGB800S24K Transient Response - Vo Deviation
 Vin = 115Vac Load: Io = 25% to 75%, 0.2A/ μ s slew rate
 Ch 2: Io Ch 3: Vo

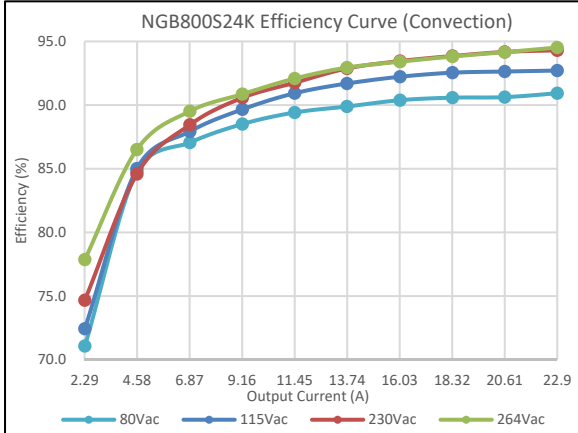

Figure 20: NGB800S24K Efficiency Curve @ 25°C (Convection)
 Loading: $I_{o_main} = 10\%I_{o_max}$ increment to I_{o_max}

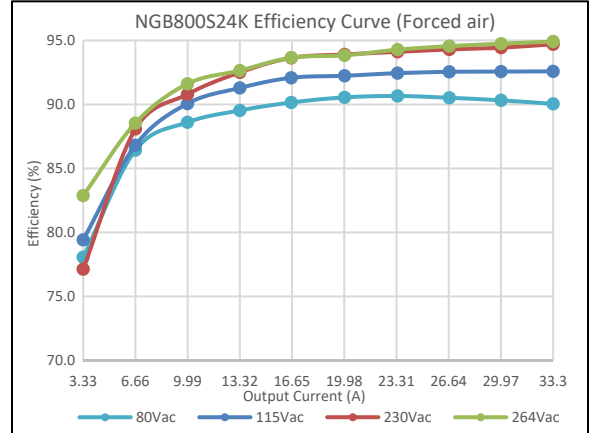

Figure 21: NGB800S24K Efficiency Curve @ 25°C (Forced air)
 Loading: $I_{o_main} = 10\%I_{o_max}$ increment to I_{o_max}

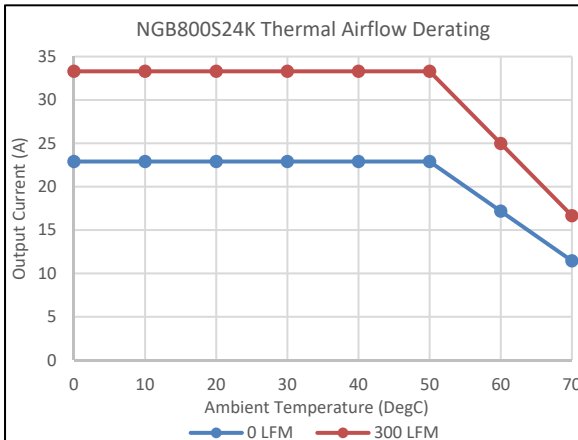

Figure 22: NGB800S24K Derating Curves
 Vin = 115Vac

ELECTRICAL SPECIFICATIONS

NGB800S48K Performance Curves

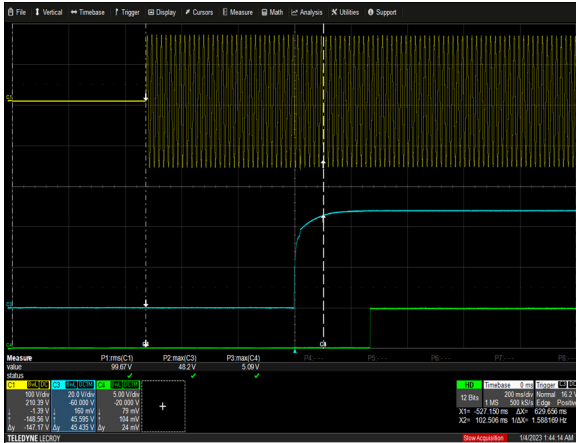

Figure 23: NGB800S48K Turn-on Delay
 Vin = 115Vac Load: Io = 16.7A
 Ch 1: V_{IN} Ch 3: Vo Ch 4: DCOK

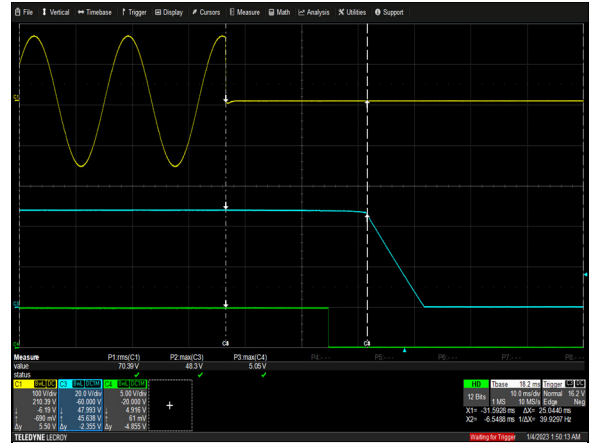

Figure 24: NGB800S48K Hold-up Time
 Vin = 115Vac Load: Io = 16.7A
 Ch 1: V_{IN} Ch 3: Vo Ch 4: DCOK

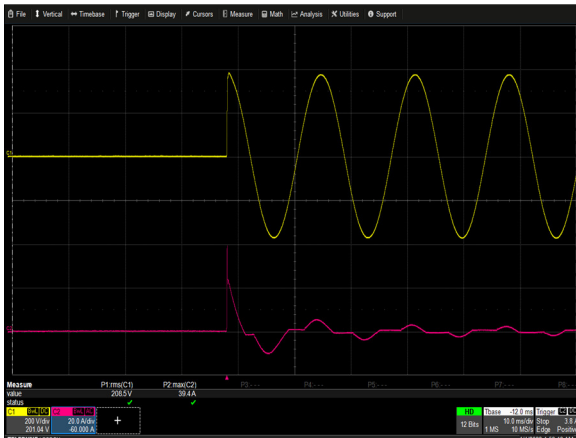

Figure 25: NGB800S48K Inrush Current
 Vin = 264Vac Load: Io = 0A, Turn on at 90 deg
 Ch 1: V_{IN} Ch 2: I_{IN}

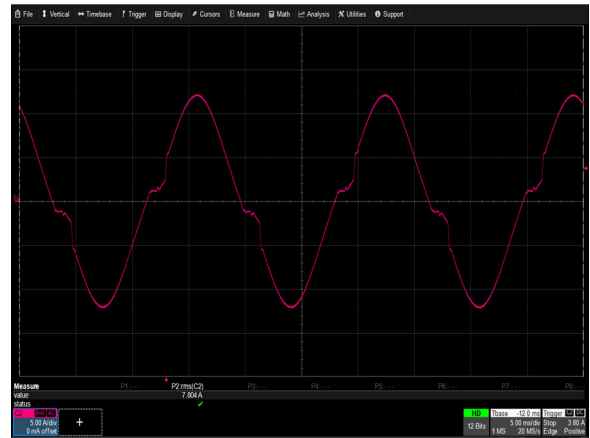

Figure 26: NGB800S48K Input Current Waveform
 Vin = 115Vac Load: Io = 16.7A
 Ch 2: I_{IN}

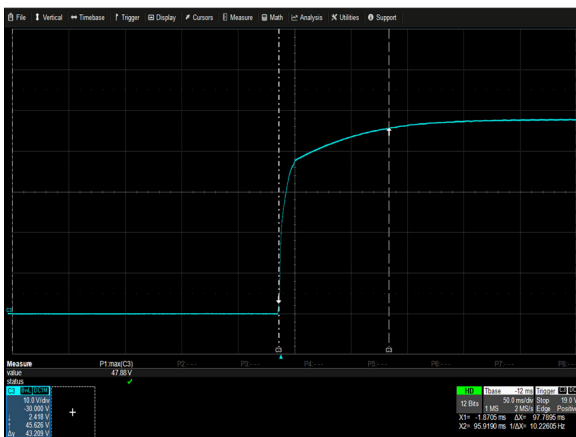

Figure 27: NGB800S48K Output Voltage Startup Characteristic
 Vin = 115Vac Load: Io = 16.7A
 Ch 3: Vo

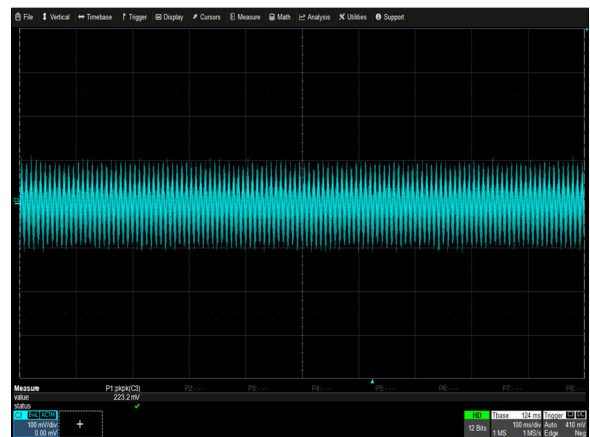

Figure 28: NGB800S48K Ripple and Noise Measurement
 Vin = 115Vac Load: Io = 16.7A
 Ch 3: Vo

ELECTRICAL SPECIFICATIONS

NGB800S48K Performance Curves

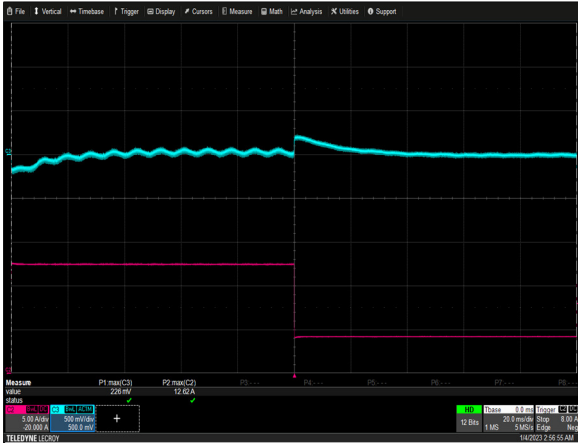

Figure 29: NGB800S48K Transient Response - Vo Deviation
 Vin = 115Vac Load: Io = 75% to 25%, 0.2A/ μ s slew rate
 Ch 2: Io Ch 3: Vo

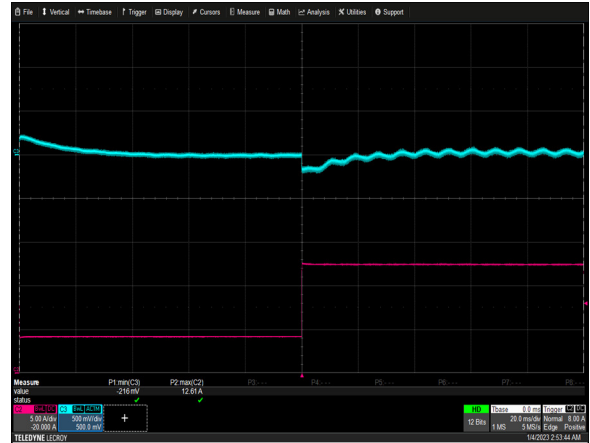

Figure 30: NGB800S48K Transient Response - Vo Deviation
 Vin = 115Vac Load: Io = 25% to 75%, 0.2A/ μ s slew rate
 Ch 2: Io Ch 3: Vo

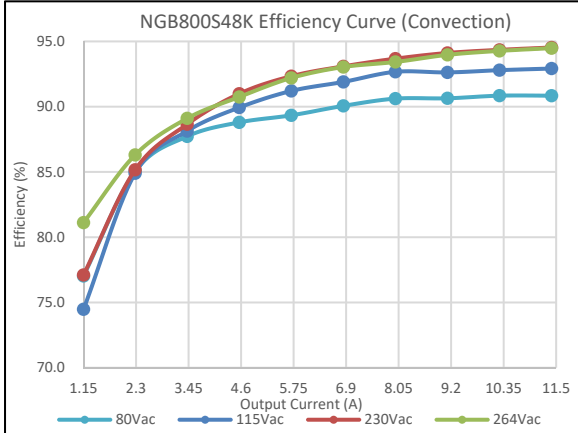

Figure 31: NGB800S48K Efficiency Curve @ 25°C (Convection)
 Loading: Io_{main} = 10%Io_{max} increment to Io_{max}

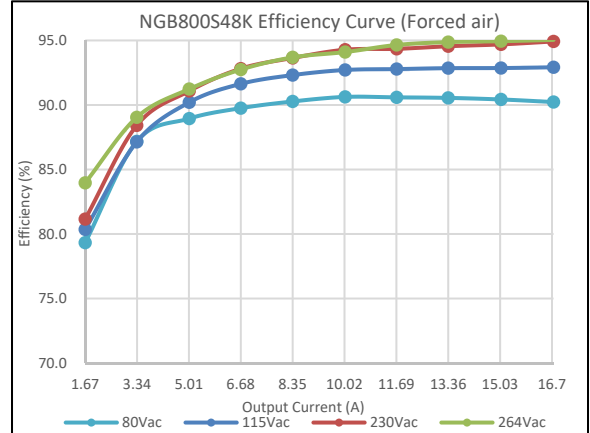

Figure 32: NGB800S48K Efficiency Curve @ 25°C (Forced air)
 Loading: Io_{main} = 10%Io_{max} increment to Io_{max}

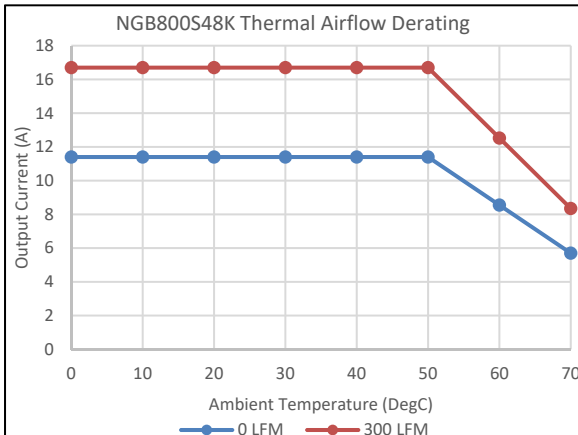

Figure 33: NGB800S48K Derating Curves
 Vin = 115Vac

ELECTRICAL SPECIFICATIONS

Protection Function Specifications

Input Fuse

NGB800 series power supply is equipped with internal non user serviceable 12 A, 250 Vac fuse for fault protection in both the line and neutral lines input.

Over Voltage Protection (OVP)

The power supply main output will latch off (less than 50% loading) during output overvoltage with the AC line recycled to reset the latch.

NGB800S12

Parameter	Min	Typ	Max	Unit
V _O Output Overvoltage	12.6	/	16.8	V

NGB800S15

Parameter	Min	Typ	Max	Unit
V _O Output Overvoltage	15.75	/	21.0	V

NGB800S24

Parameter	Min	Typ	Max	Unit
V _O Output Overvoltage	25.2	/	33.6	V

NGB800S48

Parameter	Min	Typ	Max	Unit
V _O Output Overvoltage	50.4	/	67.2	V

Short Circuit Protection (SCP)

The power supply will withstand a continuous short circuit with no permanent damage. The power supply will automatically restart when the short circuit is removed. A short is defines as impedance less than 50 milliohms.

Over Temperature Protection (OTP)

The power supply latches off during over-temperature condition and returns back to normal operation when the power supply is cooled down. The power supply might experience over-temperature conditions during a persistent overload on the output. Overload conditions can be caused by external faults. OTP might also be entered due to a loss of control of the environmental conditions, e.g. an increase in the converter's ambient temperature due to a failing fan or external cooling system etc.

ELECTRICAL SPECIFICATIONS

Protection Function Specifications

Over Current Protection (OCP)

NGB800 series power supply includes internal current limit circuitry to prevent damage in the event of overload or short circuit. In the event of overloads, the output voltage may deviate from the regulation band but recovery is automatic when the load is reduced to within specified limits.

NGB800S12

Parameter	Min	Typ	Max	Unit
V _O Output Overcurrent (forced air)	74.75	/	115	A

NGB800S15

Parameter	Min	Typ	Max	Unit
V _O Output Overcurrent (forced air)	59.8	/	92	A

NGB800S24

Parameter	Min	Typ	Max	Unit
V _O Output Overcurrent (forced air)	43.29	/	86.58	A

NGB800S48

Parameter	Min	Typ	Max	Unit
V _O Output Overcurrent (forced air)	21.71	/	33.4	A

MECHANICAL SPECIFICATIONS

Mechanical Outlines (Dimensions and Mounting Locations)

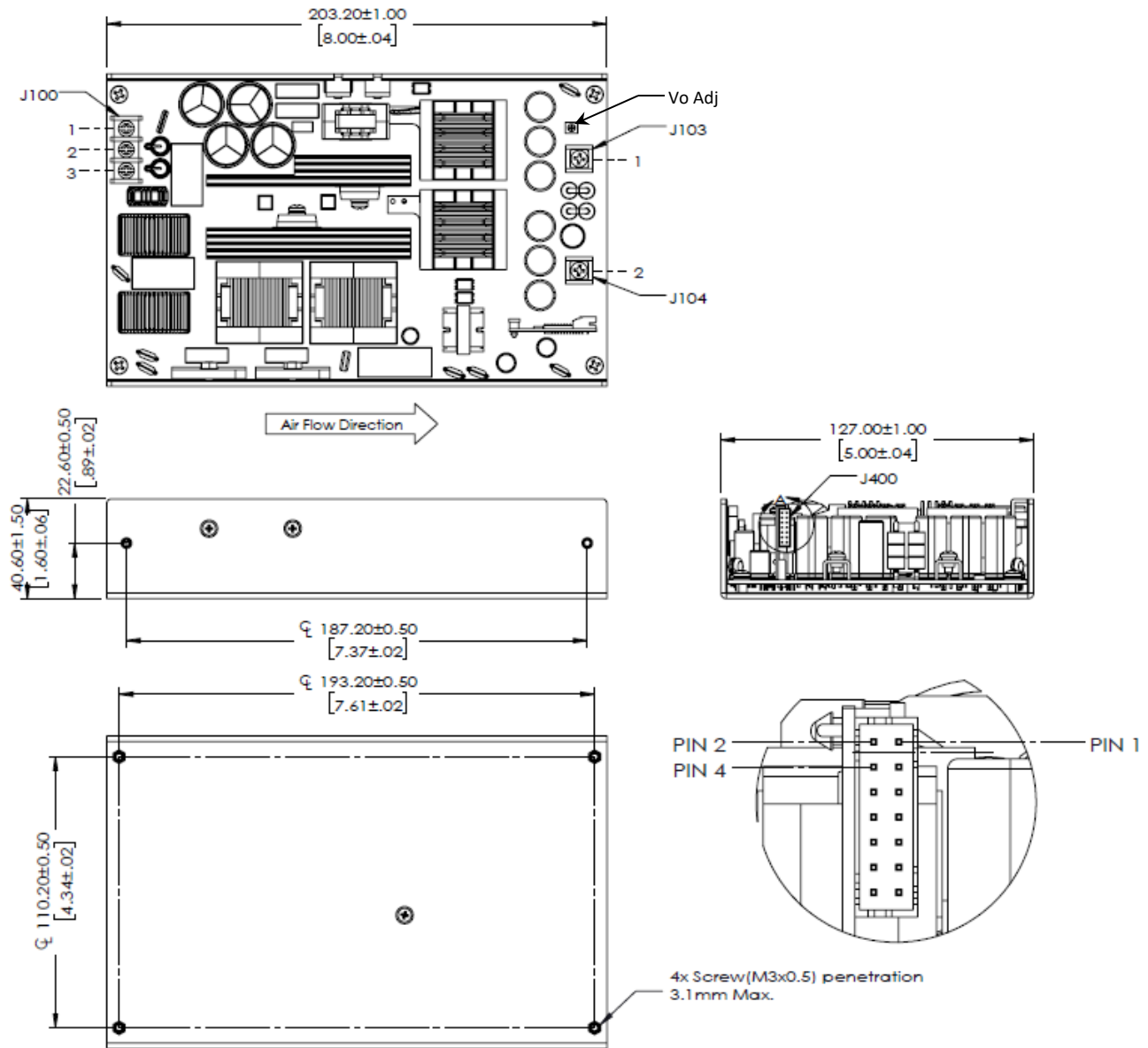

Note 1 - All dimensions in mm (inches).

Note 2 - The NGB800 series weight is 1.2kg.

Note 3 - The NGB800 series dimensions is 5" x 8" x 1.6".

MECHANICAL SPECIFICATIONS

Connector Definitions

AC Input Connector - J100

- Pin 1 - GND
- Pin 2 - Line
- Pin 3 - Neutral

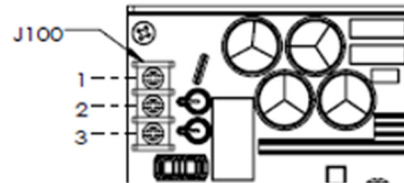

Output Connector

- J103 - +Vo
- J104 - Output Return

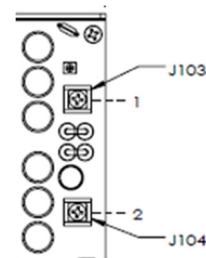

Signal Header - J400

- Pin 1 - Return
- Pin 2 - Spare
- Pin 3 - + Remote Sense
- Pin 4 - Return
- Pin 5 - Spare
- Pin 6 - DCOK
- Pin 7 - Spare
- Pin 8 - ON_OFF
- Pin 9 - Spare
- Pin 10 - Fan Output
- Pin 11 - Return
- Pin 12 - Spare
- Pin 13 - 5VSB
- Pin 14 - 5VSB

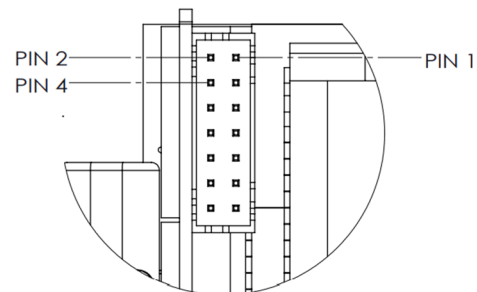
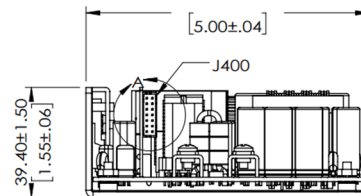

MECHANICAL SPECIFICATIONS

Power / Signal Mating Connectors and Pin Types

Table 4. Mating Connectors for NGB800 Series			
Reference	Vendor	Mating Connector or Equivalent	Mating Pins or Equivalent
J100	Molex	19141-0052/0053	/
J103/J104	Molex	19141-0058/0063/0065/0059/0064/0066	/
J400	Landwin	2050S1400	2053T021N

Potentiometer Location

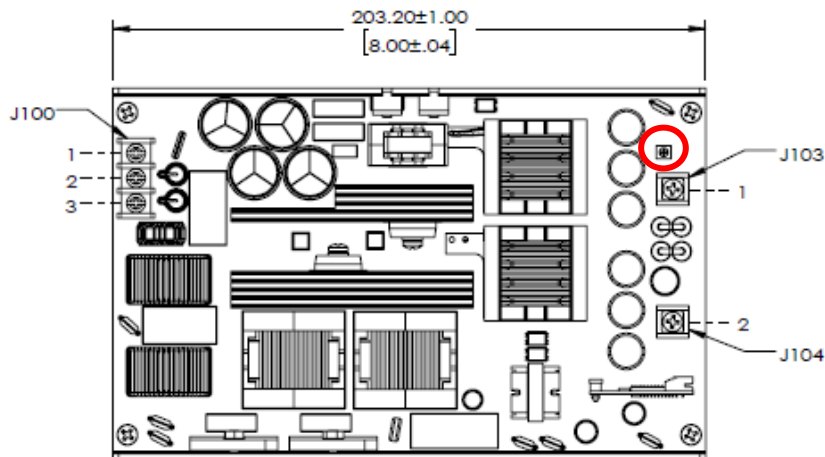

ENVIRONMENTAL SPECIFICATIONS

EMC Immunity

NGB800 series power supply is designed to meet the following EMC immunity specifications.

Table 5. Environmental Specifications	
Parameter	Specification
Conducted Emissions	EN55011/15/32: Class B, CISPR11/15/32: Class B, FCC Part 15.107, Class B Measured at 10%, 50%, and 100% load steps; 3-6db margin typ, at 120 and 230Vac
Radiated Emissions	EN55011/15/32: Class B, CISPR11/15/32: Class B, FCC Part 15.107, Class B, Measured at 10%, 50%, and 100% load steps; 3db margin typ, at 120 and 230Vac
Harmonic Current Emissions	EN61000-3-2, Class A and C at 230Vac, 100% load
Flicker	IEC61000-3-3
Electro Static Discharge (ESD) Immunity	EN55024/IEC61000-4-2, Level 4: +/- 8kV contact, +/- 15kV air, Criteria A IEC60601-1-2, 4th Edition, Table 4
Radiated RF EM Fields Susceptibility	EN55022/EN61000-4-3, 10V/m, 80MHz-2.7GHz, 80% AM at 1kHz IEC60601-1-2, 4th Edition, Table 4
Electrical Fast Transients (EFT) / Bursts	EN55024/IEC61000-4-4, Level 4, +/-4kV, 100Khz rep rate, 40A, Criteria A IEC60601-1-2, 4th Edition, Table 5
Surges - Line to Line (DM) and Line to GND (CM)	EN55024/IEC61000-4-5, Level 4, +/-2kV DM, +/-4kV CM, Criteria A IEC60601-1-2, 4th Edition
Conducted Disturbances Induced by RF Fields	EN55022/IEC61000-4-6, 3.6V/m - Level 4, 0.15 to 80Mhz; and 12V/m in ISM and amateur radio bands between 0.15Mhz and 80Mhz, 80% AM at 1KHz IEC60601-1-2, 4th Edition, Table 5
Rated Power Frequency Magnetic Fields	EN55024/IEC1000-4-8, Level 4: 30A/m, 50/60 Hz IEC60601-1-2, 4th Edition, Table 4
Voltage Interruptions, Dips, Sags & Surges ¹	EN55024/IEC/EN61000-4-11: --100% dip for 10ms, at 0, 45, 90, 135, 180, 225, 270 and 315 degrees --100% dip for 20ms, 0 deg., Criteria B at full load, criteria A @ 50% load --100% dip for 500ms (250/300 cycles), Criteria B --60% dip for 100ms, Criteria B --30% dip for 500ms, Criteria A IEC60601-1-2, 4th Edition, Table 5

Note 1 - Performance criteria are based on EN55024. According to the standards, performance criteria are defined as following:

- A - Normal performance during and after the test
- B - Temporary degradation, self-recoverable
- C - Temporary degradation, operator intervention required to recover the operation
- D - Permanent damage

ENVIRONMENTAL SPECIFICATIONS

Safety Certifications

The NGB800 series power supply is intended for inclusion in other equipment and the installer must ensure that it is in compliance with all the requirements of the end application. This product is only for inclusion by professional installers within other equipment and must not be operated as a stand alone product.

Table 6. Safety Certifications for NGB800 Series Power Supply	
Agency	Description
UL	US Requirements UL62368-1, UL60601-1, 3rd Edition, BF rated
CSA	Canada Requirements CAN/CSA-C22.2 No. 62368-1, 60601-1, BF rated
Demko	Denmark Requirements EN 62368-1, EN60601-1, 3rd Edition, BF rated
CB Certificate and Report	All CENELEC Countries Design to meet 5000m and 50°C, 93% RH with 120 h (tropical standard) according to GB4943.1-2011, IEC62368-1, IEC60601-1, BF rated
CE	CE Marking (LVD)

ENVIRONMENTAL SPECIFICATIONS

EMI Emissions

The NGB800 series has been designed to comply with the Class B limits of EMI requirements of EN55022 (FCC Part 15) and CISPR 22 (EN55032) for emissions and relevant sections of EN61000 (IEC 61000) for immunity.

Conducted Emissions

The applicable standard for conducted emissions is EN55022 (FCC Part 15). Conducted noise can appear as both differential mode and common mode noise currents. Differential mode noise is measured between the two input lines, with the major components occurring at the supply fundamental switching frequency and its harmonics. Common mode noise, a contributor to both radiated emissions and input conducted emissions, is measured between the input lines and system ground and can be broadband in nature.

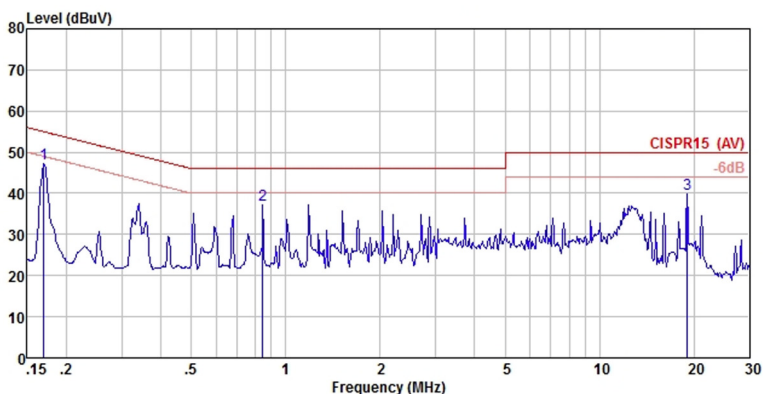

The NGB800 series power supply have internal EMI filters to ensure the convertor’s conducted EMI levels comply with EN55022 (FCC Part 15) Class B and EN55022 (CISPR 22) Class B limits.

Sample of EN55022 Conducted EMI Measurement at 120Vac input tested at Line.

Conducted EMI emissions specifications of the NGB800 series:

Parameter	Model	Symbol	Min	Typ	Max	Unit
FCC Part 15, Class B	All	Margin	-	-	6	dB
CISPR11/15/32 Class B	All	Margin	-	-	6	dB

Radiated Emissions

Unlike conducted EMI, radiated EMI performance in a system environment may differ drastically from that in a stand-alone power supply. The shielding effect provided by the system enclosure may bring the EMI level from Class A to Class B. It is thus recommended that radiated EMI be evaluated in a system environment. The applicable standard is EN55022 Class B (FCC Part 15). Testing AC-DC convertors as a stand-alone component to the exact requirements of EN55022 can be difficult, because the standard calls for 1m leads to be attached to the input and outputs and aligned such as to maximize the disturbance. In such a set-up, it is possible to form a perfect dipole antenna that very few AC-DC convertors could pass. However, the standard also states that “an attempt should be made to maximize the disturbance consistent with the typical application by varying the configuration of the test sample”.

ENVIRONMENTAL SPECIFICATIONS

Operating Temperature

The NGB800 series power supply will start and operate at an ambient temperature from -20°C to 70°C. PSU performance will derate above 50°C to 70°C, and from 0° to -20°C. PSU will derate output power linearly above 50°C to 50% rated output at 70°C.

Storage and Shipping Temperature

The NGB800 series power supply can be stored or shipped at temperatures between -40°C and +85°C.

Altitude

The NGB800 series power supply will operate within specifications at altitudes from -500m to 5,000m above sea level. The power supply will not be damaged when stored at altitudes from -500m to 12,192m above sea level.

Humidity

The NGB800 series power supply will operate within specifications when subjected to a relative humidity from 5% to 95% non-condensing.

Vibration

Non-Operating Random Vibration (Per IEC 60068-2-64)

Acceleration	1.0 gRMS
Frequency Range	10 to 500 Hz
Direction	3 mutually perpendicular axis
Duration	3 minutes per axis
Sweep Rate	1 octave / min, 10 sweeps / axes

Operating Random Vibration (Per IEC 60068-2-64)

Acceleration	1.5 gRMS, 0.003 g ² /Hz
Frequency Range	5 to 500 Hz
Direction	3 mutually perpendicular axis
Duration	10 minutes per axis

Operating Sinusoidal Vibration (Per IEC 60068-2-6)

Acceleration	1.0 gRMS
Frequency Range	10 to 500 Hz
Direction	3 mutually perpendicular axis
Duration	3 minutes per axis
Sweep Rate	1 octave / min, 20 sweeps / axis

Transportation Vibration:

Random vibration per MIL-STD-810E, Method 514.4, Cat. 1, Figure 514.4-1, 1 hr in each of three axes

ENVIRONMENTAL SPECIFICATIONS

Shock (Per IEC 60068-2-27)

Non-Operating Half-Sine Shock

Acceleration	50 g
Duration	6 ms
Pulse	Half-Sine
Number of Shock	3 shocks in each of 6 faces

Operating Half-Sine Shock

Acceleration	20 g
Duration	10 ms
Pulse	Half-Sine
Number of Shock	6 shocks total

Audible Noise

Audible noise is less than 20dbA (test per ISO7999, load at 0%, 10%, 25%, 100%, transient step loads from 0 to 25%, 25 to 50%, 50 to 100% at 10hz rep rate. From 1m distance).

RELIABILITY SPECIFICATIONS

Table 7 Reliability Specifications	
Parameter	Specification
MTBF	>500K hours (Using Telcordia SR-332, Issue 3 at 110V & 220V, for both 25°C and 50°C.)
Warranty	3 Years
Positive Temperature Excursion	Power supply withstand a 2 hour temp soak at its highest non-derated operating temperature, followed by 5°C incremental soaks for 15 min each until the unit reaches 100°C
Temperature Cycling	Power supply withstand 3 complete cycles alternating from -40°C to 90°C holding at 1 hour at each without going out of specification
E-Cap Lifetime	All specified E-Caps exceed 7-year life based on calculations at 25°C thermal environment. (115Vac/60Hz & 230Vac/50Hz, ambient 25°C at 24 hours per day, 365 days/year, 6 power up cycles per day.)
Life Cycle AC Power On / Off Test	>10,000 Cycles for each of the following: 230Vac input with 100% load at 0.5 seconds on, 59.5 seconds off, and at 100Vac input at 10 seconds on, 50 seconds off
IPC 610 Class 2	This product is a class 2 product

POWER AND CONTROL SIGNAL DESCRIPTIONS

AC Input (J100)

This connector supplies the AC Mains to the NGB800 series power supply.

Pin 1 - Line

Pin 2 - Neutral

Pin 3 - Ground

Main Output (J103, J104)

These terminals provide the main output for the NGB800. The +Vo and the Output Return terminals are the positive and negative rails, respectively of the main output of the NGB800 series power supply.

J103 - +Vo

J104 - Output return

Signal Connector (J400)

The NGB800 series contains a 14-pin signal header providing analog control interface, standby power and fan output.

Main Output Remote Sense - (Pin 3)

The main output of the NGB800 is equipped with a remote sensing capability that will compensate for a power path drop. This feature is implemented by connecting the main output remote sense (pin 3) to the positive rail of the main output at a location that is near to the load. Care should be taken in the routing of the sense lines as any noise sources or additional filtering components introduced into the voltage rail may affect the stability of the power supply. The NGB800 will operate appropriately without the sense line connected; however it is recommended that the sense line be connected directly to the main output terminals if remote sensing is not required. This remote sense circuit will not raise the power supply's output voltage to the OVP trip level.

Main output remote sense has no effect on the standby output (V_{SB}).

DCOK Signal (Pin 6)

DCOK signal will be high once the DC output rises to within the regulation (on turn-on), and go low if the DC output falls below the regulation range.

The DCOK is an output signal driven high by the power supply to indicate that all outputs are valid. If any of the power supply outputs fails below its regulation limits, this output will be driven low. The output signal is an open drain output internally pulled up in the power supply to internal standby supply.

POWER AND CONTROL SIGNAL DESCRIPTIONS

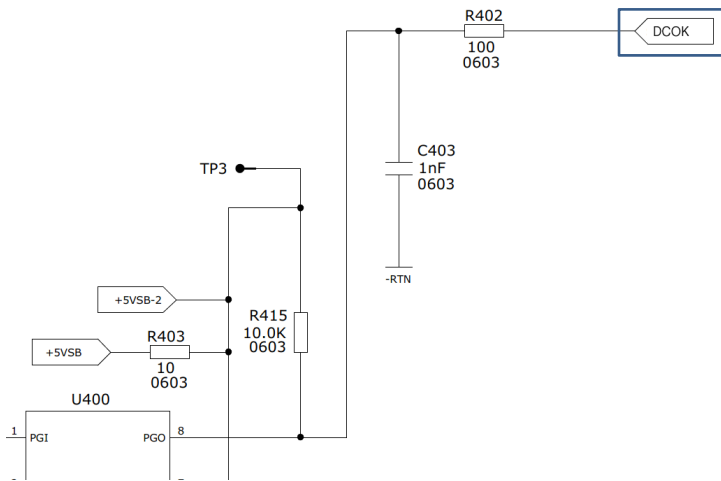

ON_OFF Signal (Pin 8)

This signal input pin controls the normal turning on and off of the main output of the NGB800 power supply. The power supply main output (V_O) will be enabled when this signal is pulled high or left open. The power supply output (except V_{SB} output) will be disabled when this input is pulled low.

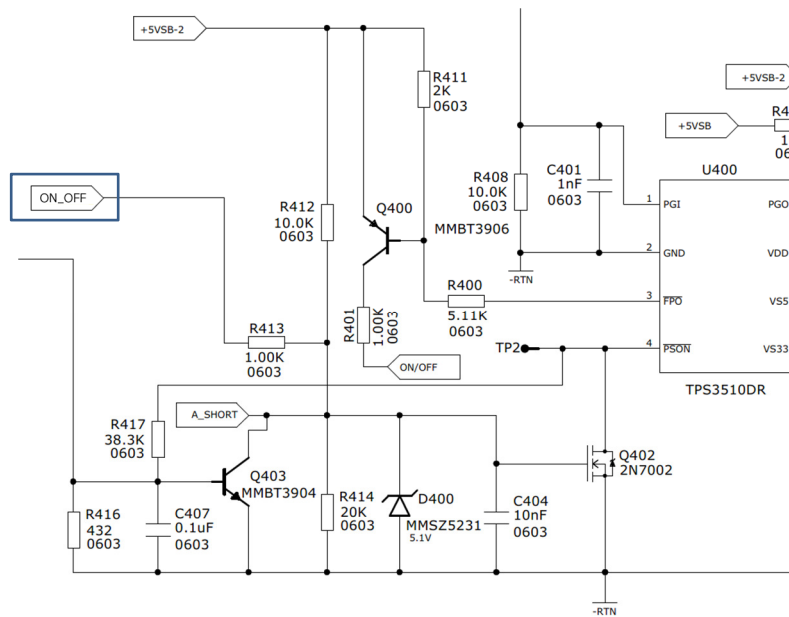

POWER AND CONTROL SIGNAL DESCRIPTIONS

Fan Output (Pin 10)

The NGB800 series power supply contains a 12V/1A output for powering a cooling fan or as an AUX power source.

Standby Output, Standby Output Return - (Pins 13, 14, 1, 4, 11)

The NGB800 provides a regulated 5V/2A standby output voltage to power critical circuitry that must remain active regardless of the on/off status of the power supply's main output. The standby output voltage is available whenever a valid AC input voltage is applied to the unit.

APPLICATION NOTES

Output Ripple and Noise Measurement

The setup outlined in the diagram below has been used for output voltage ripple and noise measurements on the NGB800 series. When measuring output ripple and noise, a scope jack in parallel with a 0.1 μ F ceramic chip capacitor, and a 10 μ F tantalum capacitor will be used. Oscilloscope can be set to 20MHz bandwidth for this measurement.

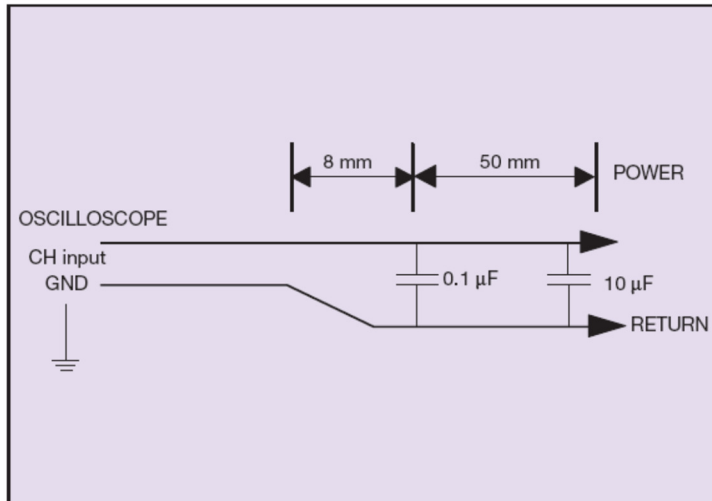

RECORD OF REVISION AND CHANGES

Issue	Date	Description	Originators
1.0	01.31.2023	First issue	E. Wang
1.1	05.04.2023	Delete Class II models	E. Wang



For international contact information,
visit advancedenergy.com.

powersales@aei.com (Sales Support)
productsupport.ep@aei.com (Technical Support)
+1 888 412 7832

ABOUT ADVANCED ENERGY

Advanced Energy (AE) has devoted more than three decades to perfecting power for its global customers. AE designs and manufactures highly engineered, precision power conversion, measurement and control solutions for mission-critical applications and processes.

Our products enable customer innovation in complex applications for a wide range of industries including semiconductor equipment, industrial, manufacturing, telecommunications, data center computing, and medical. With deep applications know-how and responsive service and support across the globe, we build collaborative partnerships to meet rapid technological developments, propel growth for our customers, and innovate the future of power.

PRECISION | POWER | PERFORMANCE | TRUST

Specifications are subject to change without notice. Not responsible for errors or omissions. ©2020 Advanced Energy Industries, Inc. All rights reserved. Advanced Energy®, and AE® are U.S. trademarks of Advanced Energy Industries, Inc.