

ARTESYN AEE 20W-M SERIES

DC/DC Converter



PRODUCT DESCRIPTION

Advanced Energy's Artesyn AEE20W-M series is a new range of high performance dc-dc converter modules with a reinforced insulation system. I/O isolation voltage is specified for 4200Vac, which rated for 300Vrms working voltage. The product comes in a compact 2"x1" industrial standard package. All 18 models available for 12, 24, 48Vdc with wide 2:1 input voltage range and tight output regulation.

The AEE20W-M series DC/DC converters offer an economical solution for demanding applications in medical instrumentation requesting a certified supplementary or reinforced insulation system to comply with the latest medical safety standards.

SPECIAL FEATURES

- 4200Vac reinforced Insulation
- Insulation rated for 300Vrms working voltage
- Medical safety certifications
- 2 x MOPP rated
- Wide 2:1 input voltage range
- Low leakage current <5uA
- Operating temperature range -40 °C to +80 °C (With derating)
- No minimum load requirement
- Overload/voltage and short circuit protection
- Input filter meets EN 55011, class A and FCC, level A
- Medical EMC Standard meets 4th Edition of EMI EN55011 and EMS EN60601-1-2
- 2"x 1" plastic package
- 3 Years product warranty

SAFETY

- EN/IEC 60601-1 3rd Edition, ANSI/AAMI ES60601-1, 2x MOPP
- CE Mark

TYPICAL APPLICATIONS

- Industrial
- Medical

TECHNICAL REFERENCE NOTE

Total Power:

20 Watts

Input Voltage:

9-18 Vdc

18-36 Vdc

36-75 Vdc

of Outputs:

Single / Dual



Model Numbers

Model	Input Voltage	Output Voltage	Maximum Load	Efficiency
AEE04A12-M	9-18Vdc	5Vdc	4A	86%
AEE02B12-M	9-18Vdc	12Vdc	1.67A	89%
AEE02C12-M	9-18Vdc	15Vdc	1.33A	88%
AEE02H12-M	9-18Vdc	24Vdc	0.84A	89%
AEE02BB12-M	9-18Vdc	± 12 Vdc	± 0.84A	89%
AEE02CC12-M	9-18Vdc	± 15 Vdc	± 0.67A	89%
AEE04A24-M	18-36Vdc	5Vdc	4A	88%
AEE02B24-M	18-36Vdc	12Vdc	1.67A	89%
AEE02C24-M	18-36Vdc	15Vdc	1.33A	89%
AEE02H24-M	18-36Vdc	24Vdc	0.84A	90%
AEE02BB24-M	18-36Vdc	± 12 Vdc	± 0.84A	90%
AEE02CC24-M	18-36Vdc	± 15 Vdc	± 0.67A	90%
AEE04A48-M	36-75Vdc	5Vdc	4A	88%
AEE02B48-M	36-75Vdc	12Vdc	1.67A	89%
AEE02C48-M	36-75Vdc	15Vdc	1.33A	90%
AEE02H48-M	36-75Vdc	24Vdc	0.84A	89%
AEE02BB48-M	36-75Vdc	± 12 Vdc	± 0.84A	89%
AEE02CC48-M	36-75Vdc	± 15 Vdc	± 0.67A	90%

Options

None

Electrical Specifications

Absolute Maximum Ratings

Stress in excess of those listed in the “Absolute Maximum Ratings” may cause permanent damage to the power supply. These are stress ratings only and functional operation of the unit is not implied at these or any other conditions above those given in the operational sections of this TRN. Exposure to any absolute maximum rated condition for extended periods may adversely affect the power supply’s reliability.

Table 1. Absolute Maximum Ratings						
Parameter	Model	Symbol	Min	Typ	Max	Unit
Input Surge Voltage 100 mSec. max	12V Input Models 24V Input Models 48V Input Models	$V_{IN,DC}$	-0.7 -0.7 -0.7	- - -	25 50 100	Vdc Vdc Vdc
Maximum Output Power	All models	$P_{O,max}$	-	-	20	W
Isolation Voltage Input to output (60 seconds)	All models		4200	-	-	Vac
Isolation Resistance (500Vdc)	All models		10	-	-	Gohm
Isolation Capacitance (100KHz,1V)	All models		-	-	80	pF
Thermal Impedance	Natural Convection		13	-	-	°C/W
Operating Ambient Temperature Range	Convection Cooling		-40		+80 ¹	°C
Operating Case Temperature	All models	T_{CASE}	-	-	+95	°C
Storage Temperature	All models	T_{STG}	-50		+125	°C
Humidity (non-condensing) Operating Non-operating	All models All models		- -	- -	95 95	% %
MTBF	MIL-HDBK-217F@25°C, Ground Benign		1000000	-	-	Hours

Note 1 - With Derating

Electrical Specifications

Input Specifications

Table 2. Input Specifications							
Parameter		Condition	Symbol	Min	Typ	Max	Unit
Operating Input Voltage, DC	12V Input Models	All	$V_{IN,DC}$	9	12	18	Vdc
	24V Input Models			18	24	36	Vdc
	48V Input Models			36	48	75	Vdc
Start-Up Threshold Voltage	12V Input Models	All	$V_{IN,ON}$	-	-	9	Vdc
	24V Input Models			-	-	18	Vdc
	48V Input Models			-	-	36	Vdc
Under Voltage Lockout	12V Input Models	All	$V_{IN,OFF}$	-	7.5	-	Vdc
	24V Input Models			-	15	-	Vdc
	48V Input Models			-	33	-	Vdc
Input reflected ripple current	12V Input Models	0 to 500KHz, 4.7uH source impedance	$I_{IN,ripple}$	-	100	-	mA
	24V Input Models			-	50	-	mA
	48V Input Models			-	30	-	mA
Input Current	AEE04A12-M	$V_{IN,DC}=V_{IN,nom}$	$I_{IN,full\ load}$	-	1938	-	mA
	AEE02B12-M			-	1876	-	mA
	AEE02C12-M			-	1893	-	mA
	AEE02H12-M			-	1888	-	mA
	AEE02BB12-M			-	1888	-	mA
	AEE02CC12-M			-	1882	-	mA
	AEE04A24-M			-	947	-	mA
	AEE02B24-M			-	938	-	mA
	AEE02C24-M			-	936	-	mA
	AEE02H24-M			-	933	-	mA
	AEE02BB24-M			-	933	-	mA
	AEE02CC24-M			-	931	-	mA
	AEE04A48-M			-	473	-	mA
	AEE02B48-M			-	469	-	mA
	AEE02C48-M			-	463	-	mA
	AEE02H48-M			-	472	-	mA
AEE02BB48-M	-	472	-	mA			
AEE02CC48-M	-	465	-	mA			
No Load Input Current (V_O On, $I_O = 0A$)	12V Input Models	$V_{IN,DC}=V_{IN,nom}$	I_{IN,no_load}	-	20	-	mA
	24V Input Models			-	15	-	mA
	48V Input Models			-	10	-	mA

Electrical Specifications

Input Specifications

Table 2. Input Specifications con't							
Parameter		Condition	Symbol	Min	Typ	Max	Unit
Efficiency @Max. Load	AEE04A12-M	$V_{IN,DC}=V_{IN,nom}$ $I_O=I_{O,max}$ $T_A=25^{\circ}C$	η	-	86	-	%
	AEE02B12-M			-	89	-	%
	AEE02C12-M			-	88	-	%
	AEE02H12-M			-	89	-	%
	AEE02BB12-M			-	89	-	%
	AEE02CC12-M			-	89	-	%
	AEE04A24-M			-	88	-	%
	AEE02B24-M			-	89	-	%
	AEE02C24-M			-	89	-	%
	AEE02H24-M			-	90	-	%
	AEE02BB24-M			-	90	-	%
	AEE02CC24-M			-	90	-	%
	AEE04A48-M			-	88	-	%
	AEE02B48-M			-	89	-	%
	AEE02C48-M			-	90	-	%
	AEE02H48-M			-	89	-	%
AEE02BB48-M	-	89	-	%			
AEE02CC48-M	-	90	-	%			
Leakage current		$V_{IN,DC}=240Vac$ $F=60Hz$	$I_{leakage}$	-	-	5	μA
Internal Filter Type		All	Internal Pi Type				

Electrical Specifications

Output Specifications

Table 3. Output Specifications							
Parameter		Condition	Symbol	Min	Typ	Max	Unit
Output Voltage Set -Point		$V_{IN,DC}=V_{IN,nom}$ $I_O=I_{O,max}$ $T_A=25\text{ }^\circ\text{C}$	$\pm\%V_O$	-	1	-	%
Output Voltage Balance	Dual Output, Balanced Loads	All	$\pm\%V_O$	-	-	2.0	%
Output Current	AEE04A12-M	Convection Cooling	I_O	-	-	4	A
	AEE02B12-M			-	-	1.67	A
	AEE02C12-M			-	-	1.33	A
	AEE02H12-M			-	-	0.84	A
	AEE02BB12-M			-	-	± 0.84	A
	AEE02CC12-M			-	-	± 0.67	A
	AEE04A24-M			-	-	4	A
	AEE02B24-M			-	-	1.67	A
	AEE02C24-M			-	-	1.33	A
	AEE02H24-M			-	-	0.84	A
	AEE02BB24-M			-	-	± 0.84	A
	AEE02CC24-M			-	-	± 0.67	A
	AEE04A48-M			-	-	4	A
	AEE02B48-M			-	-	1.67	A
	AEE02C48-M			-	-	1.33	A
AEE02H48-M	-	-	0.84	A			
AEE02BB48-M	-	-	± 0.84	A			
AEE02CC48-M	-	-	± 0.67	A			
Load Capacitance ¹	AEE04A12-M	All		-	-	6800	μF
	AEE02B12-M			-	-	1160	μF
	AEE02C12-M			-	-	750	μF
	AEE02H12-M			-	-	295	μF
	AEE02BB12-M			-	-	590#	μF
	AEE02CC12-M			-	-	380#	μF
	AEE04A24-M			-	-	6800	μF
	AEE02B24-M			-	-	1160	μF
	AEE02C24-M			-	-	750	μF
	AEE02H24-M			-	-	295	μF
	AEE02BB24-M			-	-	590#	μF
	AEE02CC24-M			-	-	380#	μF
	AEE04A48-M			-	-	6800	μF
	AEE02B48-M			-	-	1160	μF
	AEE02C48-M			-	-	750	μF
AEE02H48-M	-	-	295	μF			
AEE02BB48-M	-	-	590#	μF			
AEE02CC48-M	-	-	380#	μF			

Note 1 - # for each output

Electrical Specifications

Output Specifications

Table 3. Output Specifications Con't								
Parameter		Condition	Symbol	Min	Typ	Max	Unit	
Start Up Time (Power On)		$V_{IN,DC}=V_{IN,nom}$ $I_O=I_{O,max}$ Resistive Load	$T_{Turn-On}$	-	-	30	mSec	
Line Regulation		$V_{IN,DC}=V_{IN,min}$ to $V_{IN,max}$	$\pm\%V_O$	-	-	0.5	%	
Load Regulation	Single Output	$I_O=I_{O,min}$ to $I_{O,max}$	$\pm\%V_O$	-	-	0.5	%	
	Dual Output		$\pm\%V_O$	-	-	1.0	%	
Switching Frequency		All	f_{SW}	-	285	-	KHz	
V_O Dynamic Response		25% load change	Peak Deviation	$\pm\%V_O$	-	± 3	± 5	%
			Settling Time	t_s	-	-	300	uSec
Temperature Coefficient		All	$\%/^{\circ}C$	-	-	0.02	%	
Output Over Current Protection ²		All	$\%I_{O,max}$	-	150	-	%	
Output Short Circuit Protection		All		Hiccup Mode 0.7 Hz type, Automatic Recovery				
Output Over Voltage Protection	AEE04A12-M	All		-	6.2	-	Vdc	
	AEE02B12-M		-	15	-	Vdc		
	AEE02C12-M		-	18	-	Vdc		
	AEE02H12-M		-	27	-	Vdc		
	AEE02BB12-M		-	± 15	-	Vdc		
	AEE02CC12-M		-	± 18	-	Vdc		
	AEE04A24-M		-	6.2	-	Vdc		
	AEE02B24-M		-	15	-	Vdc		
	AEE02C24-M		-	18	-	Vdc		
	AEE02H24-M		-	27	-	Vdc		
	AEE02BB24-M		-	± 15	-	Vdc		
	AEE02CC24-M		-	± 18	-	Vdc		
	AEE04A48-M		-	6.2	-	Vdc		
	AEE02B48-M		-	15	-	Vdc		
	AEE02C48-M		-	18	-	Vdc		
	AEE02H48-M		-	27	-	Vdc		
	AEE02BB48-M		-	± 15	-	Vdc		
AEE02CC48-M	-	± 18	-	Vdc				

Note 2 - Hiccup Automatic Recovery

Electrical Specifications

Output Specifications

Table 3. Output Specifications Con't							
Parameter		Condition	Symbol	Min	Typ	Max	Unit
Output Ripple, pk-pk	AEE04A12-M	Measure with a 4.7uF ceramic capacitor in parallel with a 10uF tantalum capacitor, 0 to 20MHz bandwidth	V_O	-	50	-	mV _{PK-PK}
	AEE02B12-M			-	100	-	mV _{PK-PK}
	AEE02C12-M			-	100	-	mV _{PK-PK}
	AEE02H12-M			-	150	-	mV _{PK-PK}
	AEE02BB12-M			-	100	-	mV _{PK-PK}
	AEE02CC12-M			-	100	-	mV _{PK-PK}
	AEE04A24-M			-	50	-	mV _{PK-PK}
	AEE02B24-M			-	100	-	mV _{PK-PK}
	AEE02C24-M			-	100	-	mV _{PK-PK}
	AEE02H24-M			-	150	-	mV _{PK-PK}
	AEE02BB24-M			-	100	-	mV _{PK-PK}
	AEE02CC24-M			-	100	-	mV _{PK-PK}
	AEE04A48-M			-	50	-	mV _{PK-PK}
	AEE02B48-M			-	100	-	mV _{PK-PK}
	AEE02C48-M			-	100	-	mV _{PK-PK}
	AEE02H48-M			-	150	-	mV _{PK-PK}
AEE02BB48-M	-	100	-	mV _{PK-PK}			
AEE02CC48-M	-	100	-	mV _{PK-PK}			

Electrical Specifications

AEE04A12-M Performance Curves

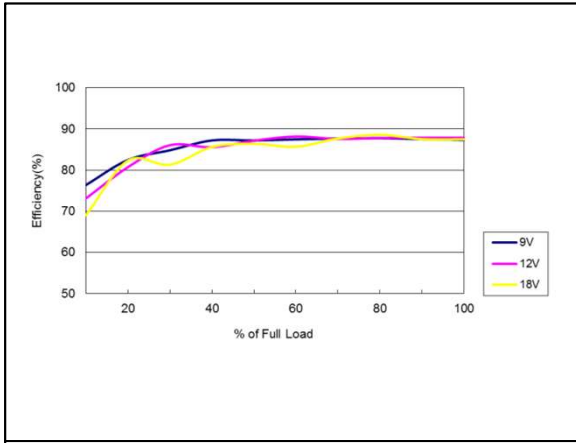

Figure 1: AEE04A12-M Efficiency Versus Output Current Curve
 Vin = 9 to 18Vdc Load: Io = 0 to 4A

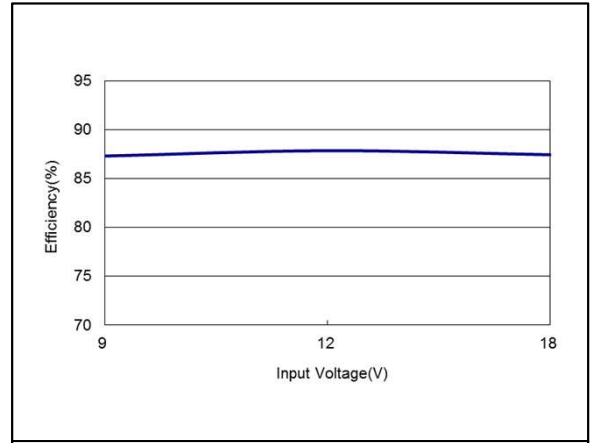

Figure 2: AEE04A12-M Efficiency Versus Input Voltage Curve
 Vin = 9 to 18Vdc Load: Io = 4A

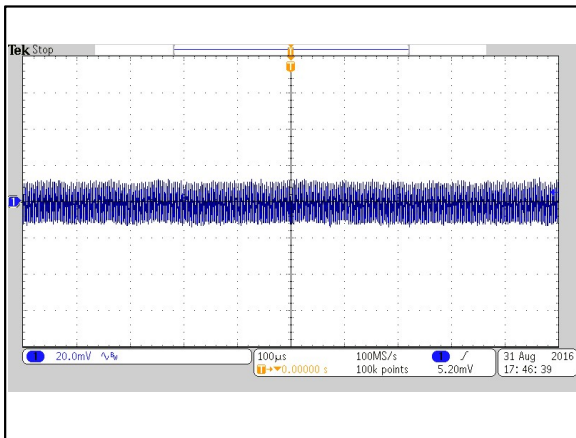

Figure 3: AEE04A12-M Ripple and Noise Measurement
 Vin = 12Vdc Load: Io = 4A
 Ch 1: Vo

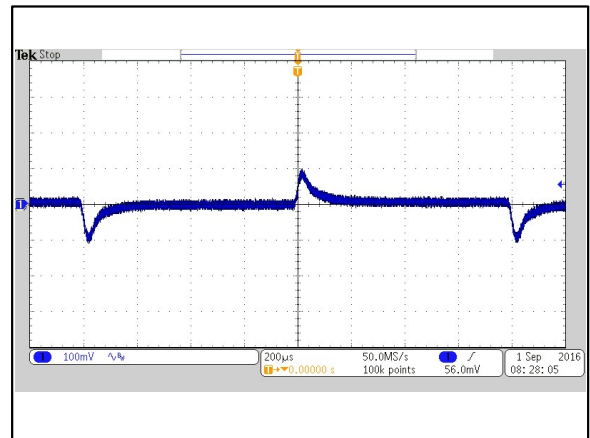

Figure 4: AEE04A12-M Transient Response
 Vin = 12Vdc Load: Io = 100% to 75% load change
 Ch 1: Vo

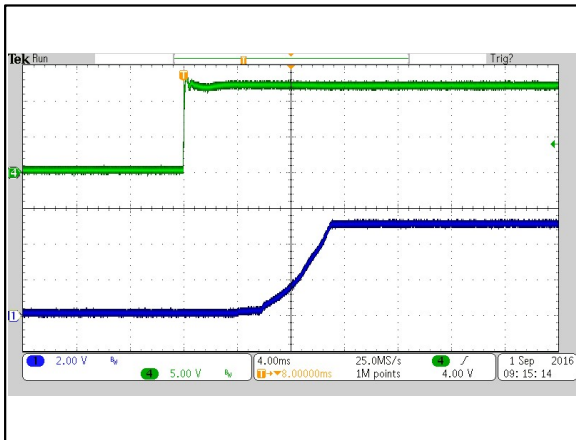

Figure 5: AEE04A12-M Output Voltage Startup Characteristic by Vin
 Vin = 12Vdc Load: Io = 4A
 Ch 1: Vo Ch 4: Vin

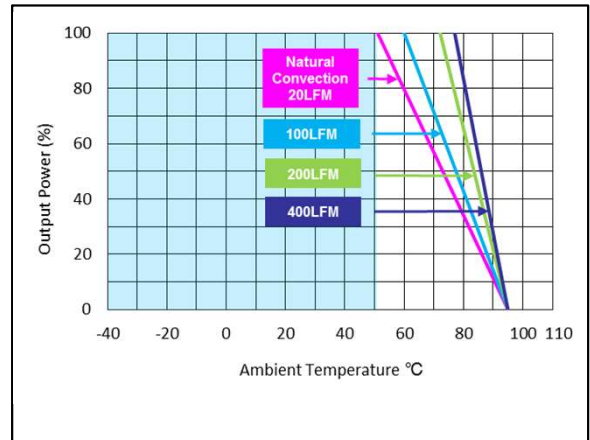

Figure 6: AEE04A12-M Derating Output Current vs Ambient Temp.
 Vin = 12Vdc Load: Io = 4A

Electrical Specifications

AEE02B12-M Performance Curves

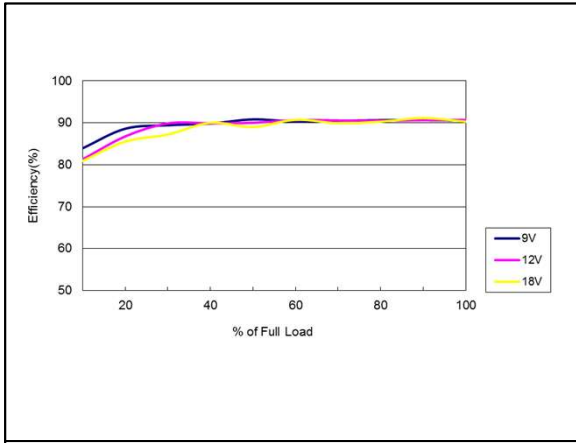

Figure 7: AEE02B12-M Efficiency Versus Output Current Curve
 Vin = 9 to 18Vdc Load: Io = 0 to 1.67A

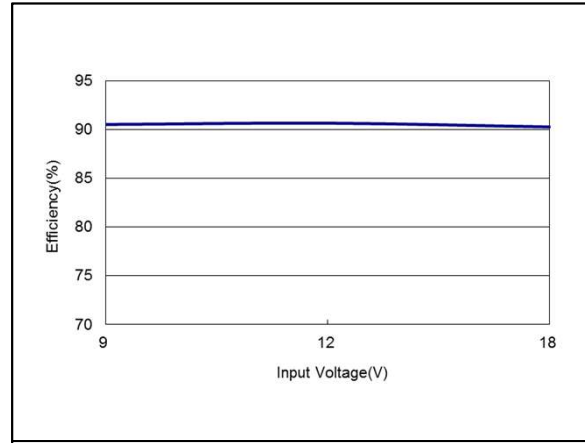

Figure 8: AEE02B12-M Efficiency Versus Input Voltage Curve
 Vin = 9 to 18Vdc Load: Io = 1.67A

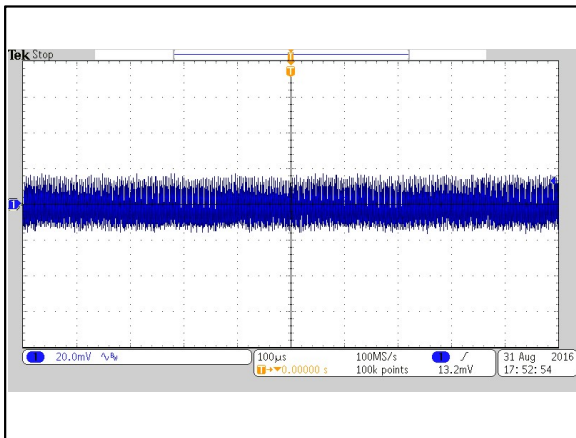

Figure 9: AEE02B12-M Ripple and Noise Measurement
 Vin = 12Vdc Load: Io = 1.67A
 Ch 1: Vo

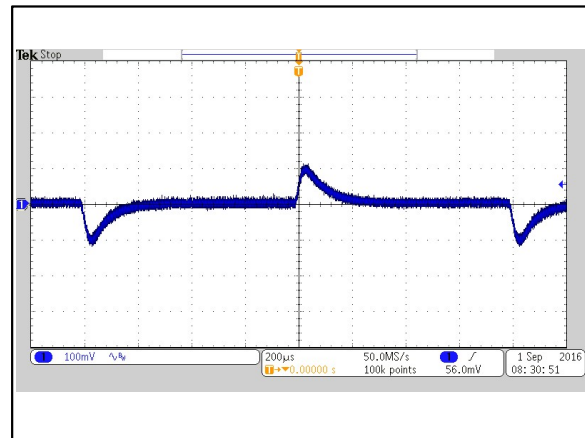

Figure 10: AEE02B12-M Transient Response
 Vin = 12Vdc Load: Io = 100% to 75% load change
 Ch 1: Vo

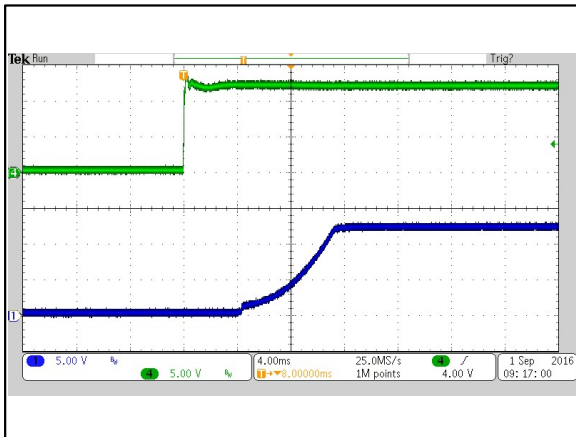

Figure 11: AEE02B12-M Output Voltage Startup Characteristic by Vin
 Vin = 12Vdc Load: Io = 1.67A
 Ch 1: Vo Ch 4: Vin

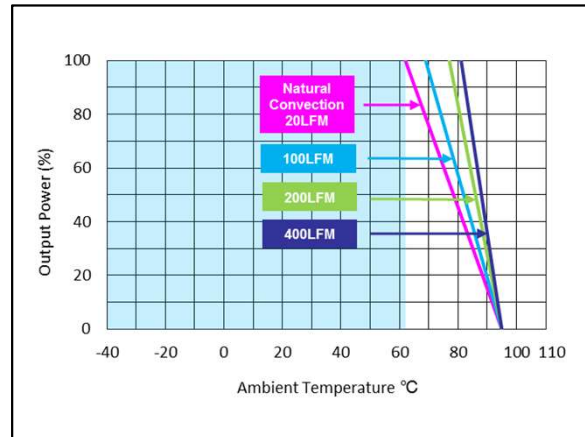

Figure 12: AEE02B12-M Derating Output Current vs Ambient Temp.
 Vin = 12Vdc Load: Io = 1.67A

Electrical Specifications

AEE02C12-M Performance Curves

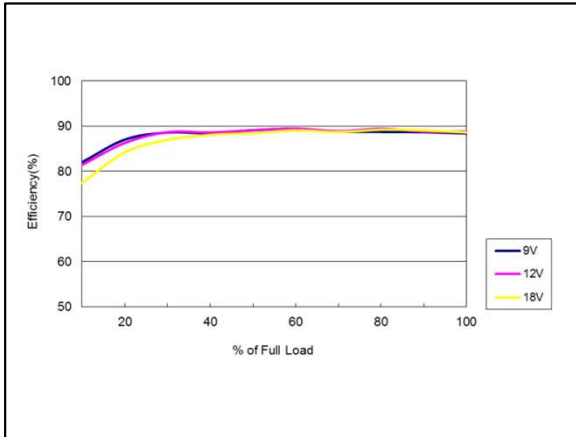

Figure 13: AEE02C12-M Efficiency Versus Output Current Curve
 Vin = 9 to 18Vdc Load: Io = 0 to 1.33A

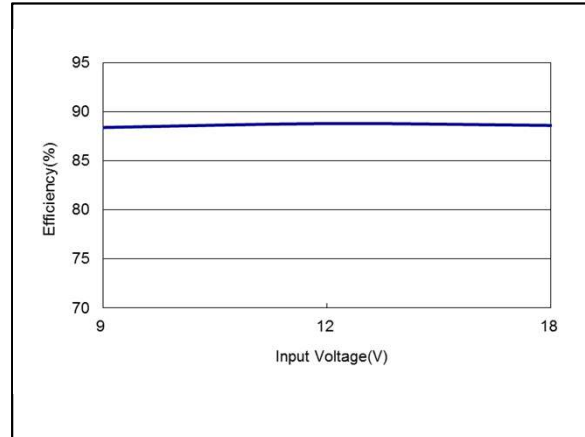

Figure 14: AEE02C12-M Efficiency Versus Input Voltage Curve
 Vin = 9 to 18Vdc Load: Io = 1.33A

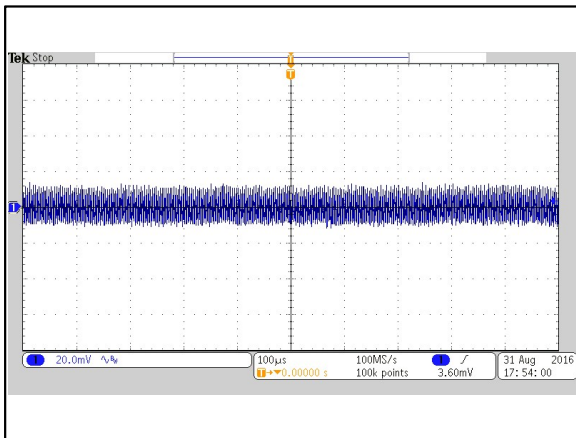

Figure 15: AEE02C12-M Ripple and Noise Measurement
 Vin = 12Vdc Load: Io = 1.33A
 Ch 1: Vo

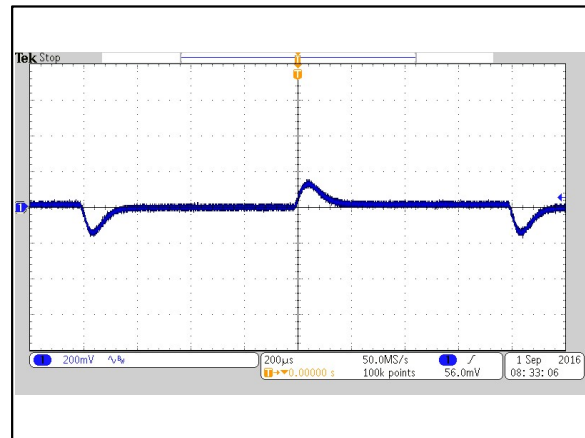

Figure 16: AEE02C12-M Transient Response
 Vin = 12Vdc Load: Io = 100% to 75% load change
 Ch 1: Vo

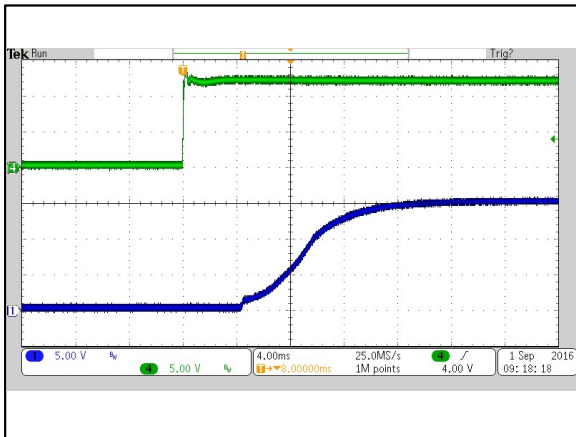

Figure 17: AEE02C12-M Output Voltage Startup Characteristic by Vin
 Vin = 12Vdc Load: Io = 1.33A
 Ch 1: Vo Ch 4: Vin

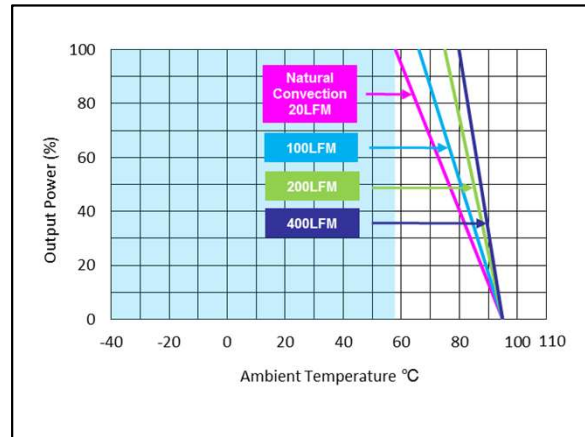

Figure 18: AEE02C12-M Derating Output Current vs Ambient Temp.
 Vin = 12Vdc Load: Io = 1.33A

Electrical Specifications

AEE02H12-M Performance Curves

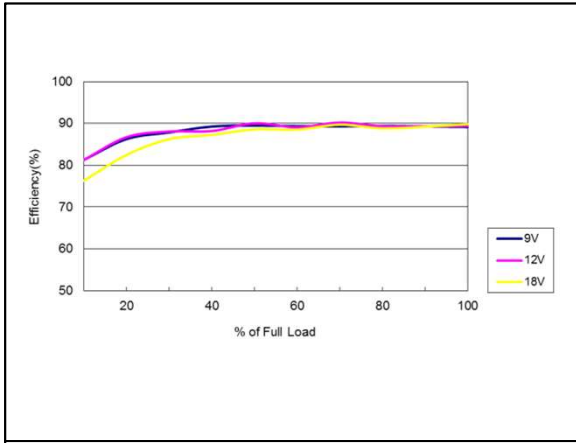

Figure 19: AEE02H12-M Efficiency Versus Output Current Curve
 Vin = 9 to 18Vdc Load: Io = 0 to 0.84A

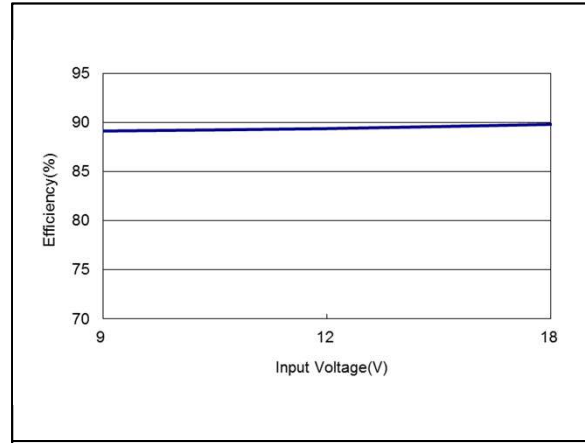

Figure 20: AEE02H12-M Efficiency Versus Input Voltage Curve
 Vin = 9 to 18Vdc Load: Io = 0.84A

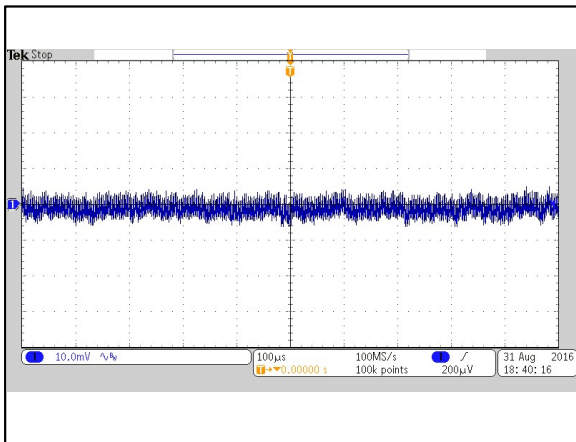

Figure 21: AEE02H12-M Ripple and Noise Measurement
 Vin = 12Vdc Load: Io = 0.84A
 Ch 1: Vo

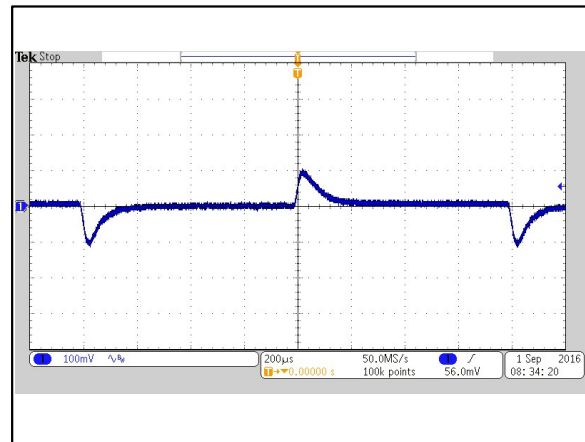

Figure 22: AEE02H12-M Transient Response
 Vin = 12Vdc Load: Io = 100% to 75% load change
 Ch 1: Vo

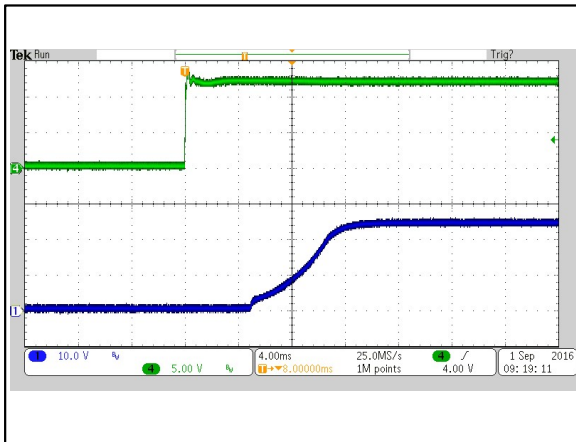

Figure 23: AEE02H12-M Output Voltage Startup Characteristic by Vin
 Vin = 12Vdc Load: Io = 0.84A
 Ch 1: Vo Ch 4: Vin

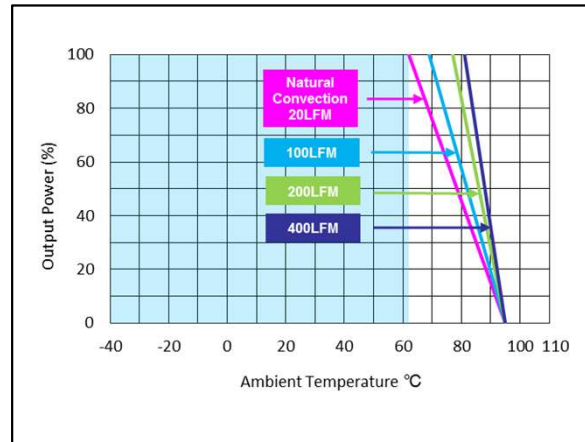

Figure 24: AEE02H12-M Derating Output Current vs Ambient Temp.
 Vin = 12Vdc Load: Io = 0.84A

Electrical Specifications

AEE02BB12-M Performance Curves

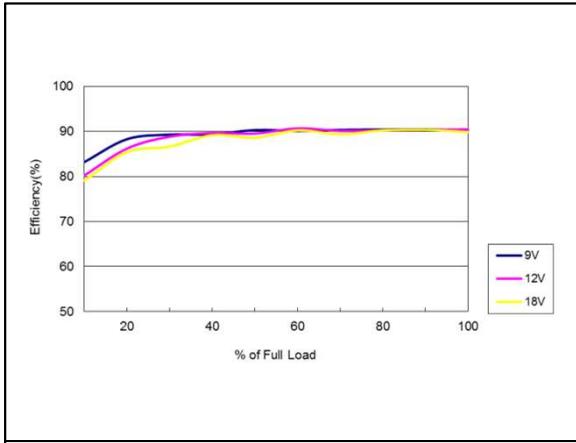

Figure 25: AEE02BB12-M Efficiency Versus Output Current Curve
 Vin = 9 to 18Vdc Load: Io = 0 to ±0.84A

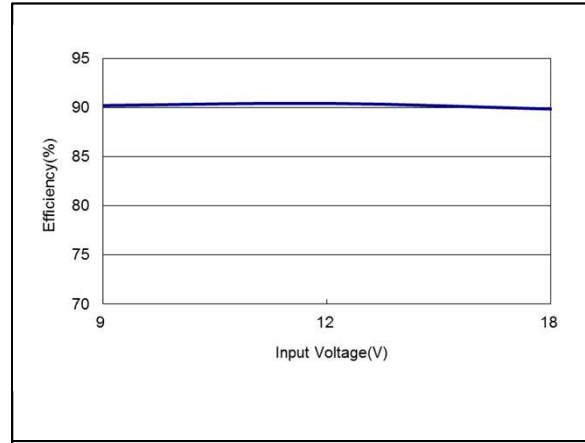

Figure 26: AEE02BB12-M Efficiency Versus Input Voltage Curve
 Vin = 9 to 18Vdc Load: Io = ±0.84A

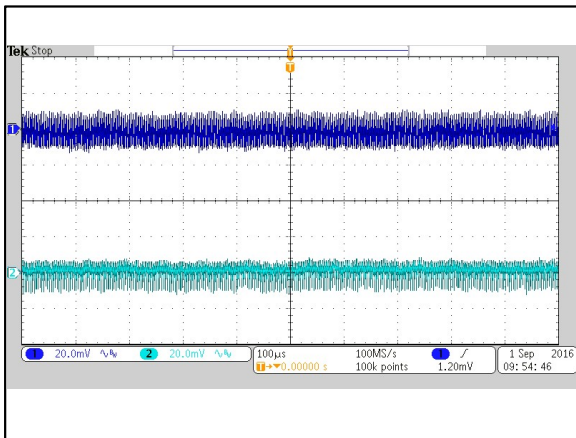

Figure 27: AEE02BB12-M Ripple and Noise Measurement
 Vin = 12Vdc Load: Io = ±0.84A
 Ch 1: Vo1 Ch 2: Vo2

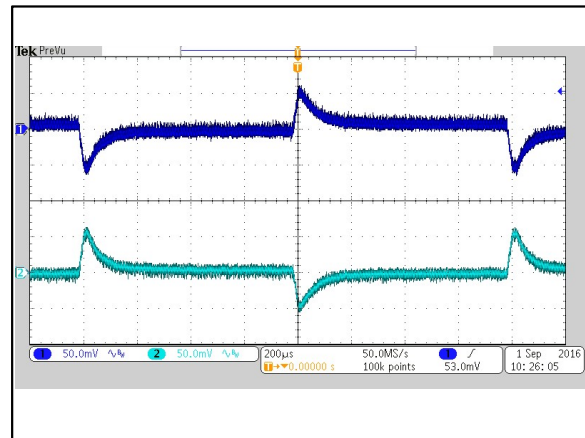

Figure 28: AEE02BB12-M Transient Response
 Vin = 12Vdc Load: Io = 100% to 75% load change
 Ch 1: Vo1 Ch 2: Vo2

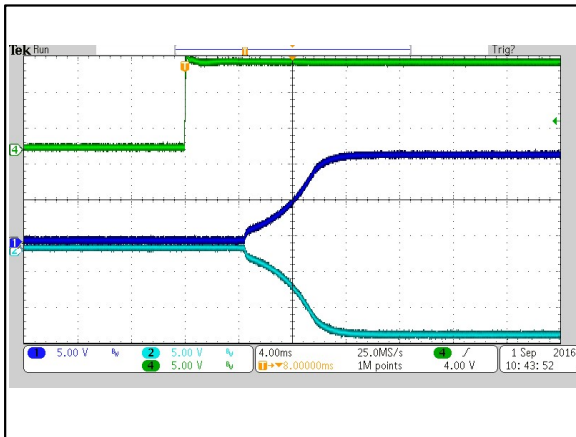

Figure 29: AEE02BB12-M Output Voltage Startup Characteristic by Vin
 Vin = 12Vdc Load: Io = ±0.84A
 Ch 1: Vo Ch 4: Vin

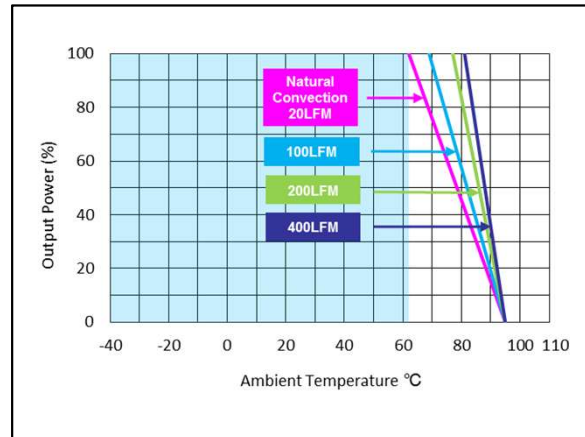

Figure 30: AEE02BB12-M Derating Output Current vs Ambient Temp.
 Vin = 12Vdc Load: Io = ±0.84A

Electrical Specifications

AEE02CC12-M Performance Curves

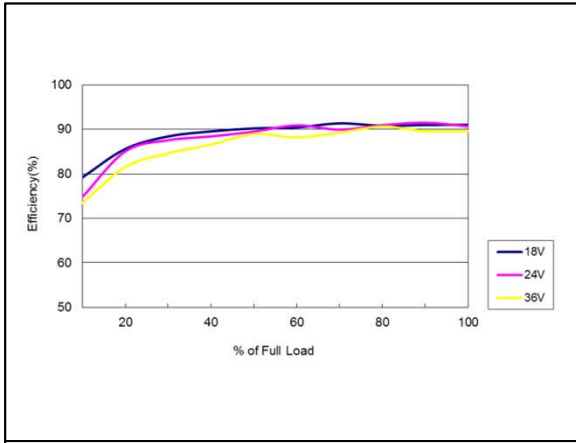

Figure 31: AEE02CC12-M Efficiency Versus Output Current Curve
 Vin = 9 to 18Vdc Load: Io = 0 to ±0.67A

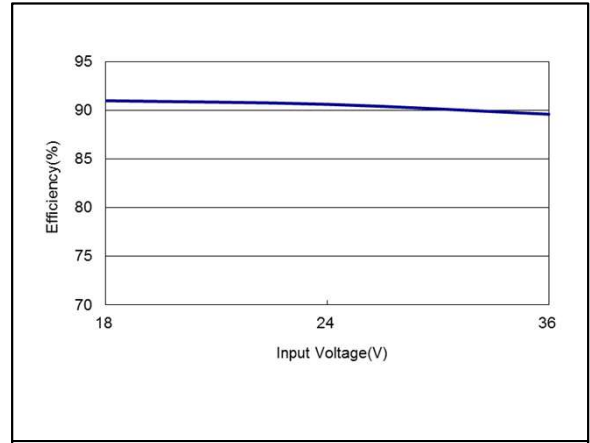

Figure 32: AEE02CC12-M Efficiency Versus Input Voltage Curve
 Vin = 9 to 18Vdc Load: Io = ±0.67A

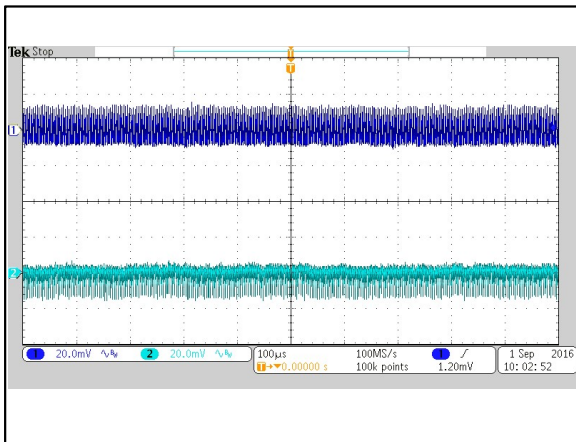

Figure 33: AEE02CC12-M Ripple and Noise Measurement
 Vin = 12Vdc Load: Io = ±0.67A
 Ch 1: Vo1 Ch 2: Vo2

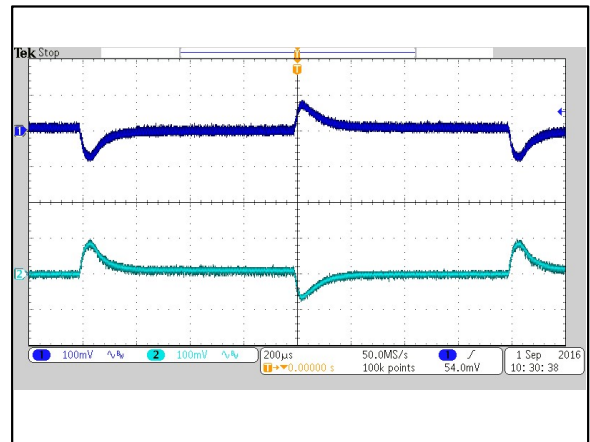

Figure 34: AEE02CC12-M Transient Response
 Vin = 12Vdc Load: Io = 100% to 75% load change
 Ch 1: Vo1 Ch 2: Vo2

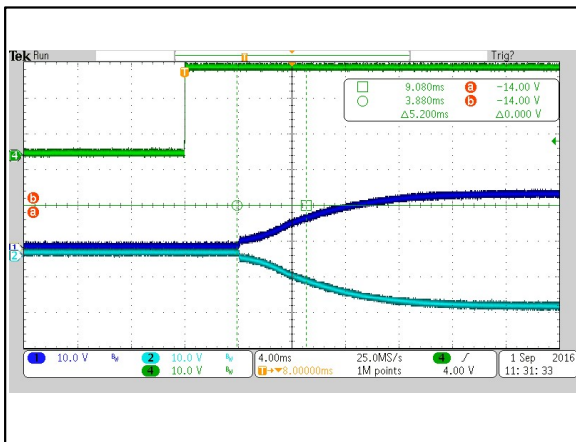

Figure 35: AEE02CC12-M Output Voltage Startup Characteristic by Vin
 Vin = 12Vdc Load: Io = ±0.67A
 Ch 1: Vo Ch 4: Vin

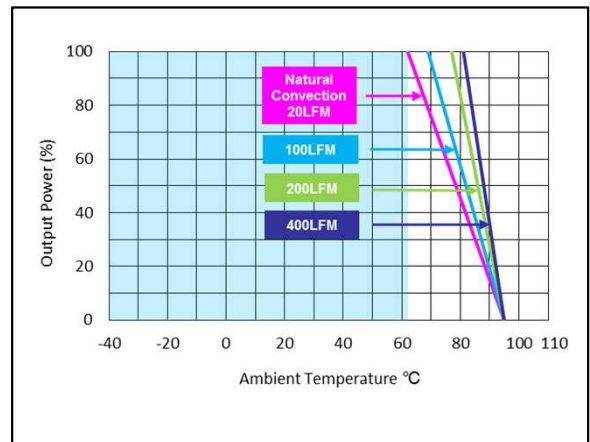

Figure 36: AEE02CC12-M Derating Output Current vs Ambient Temp.
 Vin = 12Vdc Load: Io = ±0.67A

Electrical Specifications

AEE04A24-M Performance Curves

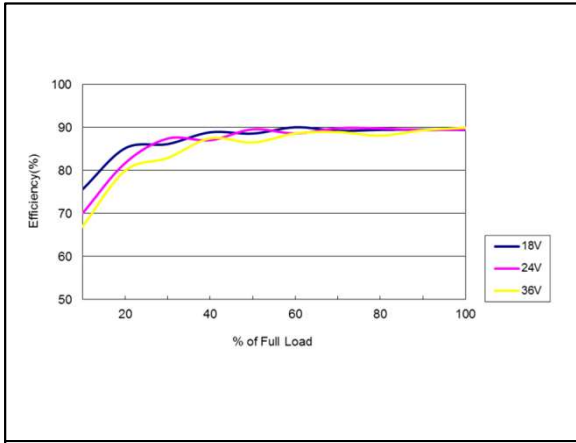

Figure 37: AEE04A24-M Efficiency Versus Output Current Curve
 Vin = 18 to 36Vdc Load: Io = 0 to 4A

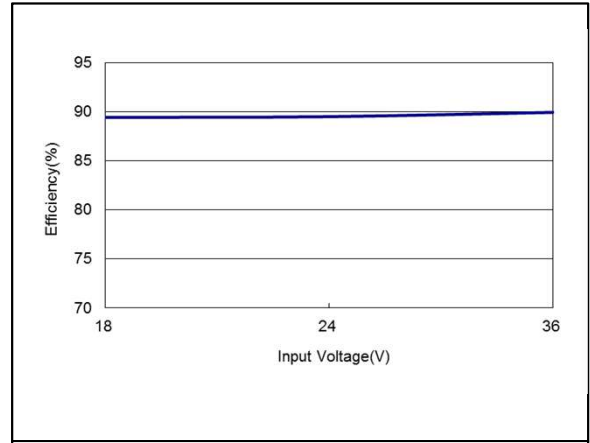

Figure 38: AEE04A24-M Efficiency Versus Input Voltage Curve
 Vin = 18 to 36Vdc Load: Io = 4A

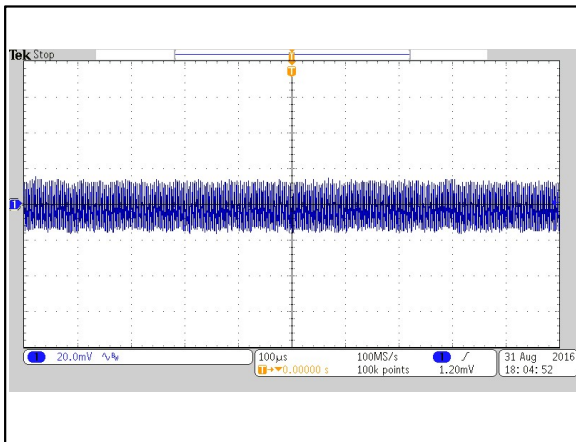

Figure 39: AEE04A24-M Ripple and Noise Measurement
 Vin = 24Vdc Load: Io = 4A
 Ch 1: Vo1

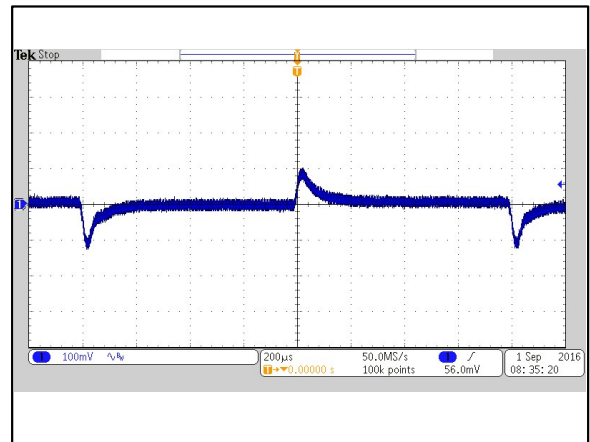

Figure 40: AEE04A24-M Transient Response
 Vin = 24Vdc Load: Io = 100% to 75% load change
 Ch 1: Vo1

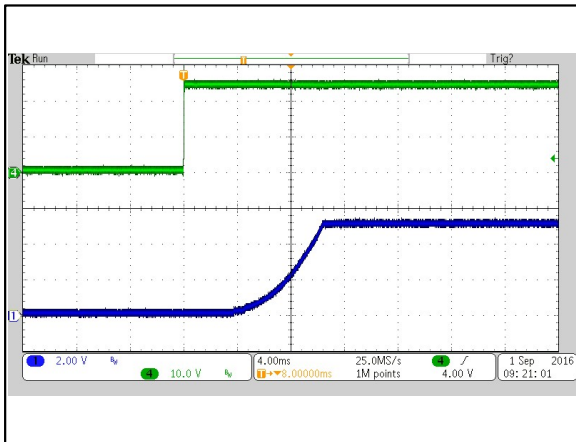

Figure 41: AEE04A24-M Output Voltage Startup Characteristic by Vin
 Vin = 24Vdc Load: Io = 4A
 Ch 1: Vo Ch 4: Vin

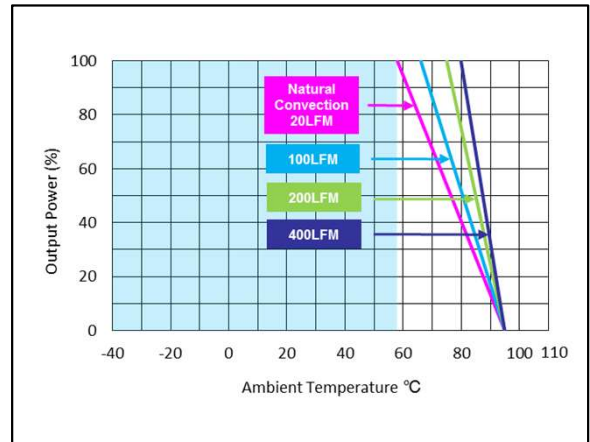

Figure 42: AEE04A24-M Derating Output Current vs Ambient Temp.
 Vin = 24Vdc Load: Io = 4A

Electrical Specifications

AEE02B24-M Performance Curves

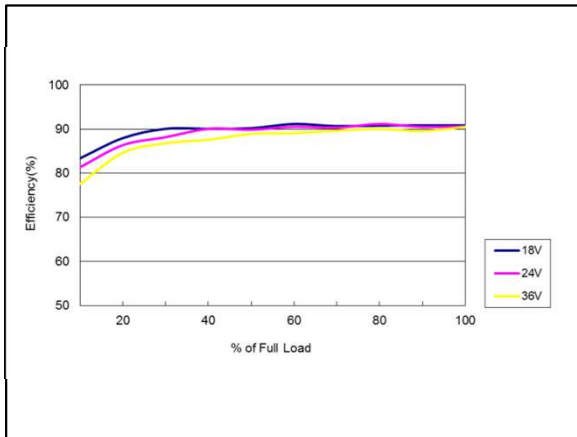

Figure 43: AEE02B24-M Efficiency Versus Output Current Curve
 Vin = 18 to 36Vdc Load: Io = 0 to 1.67A

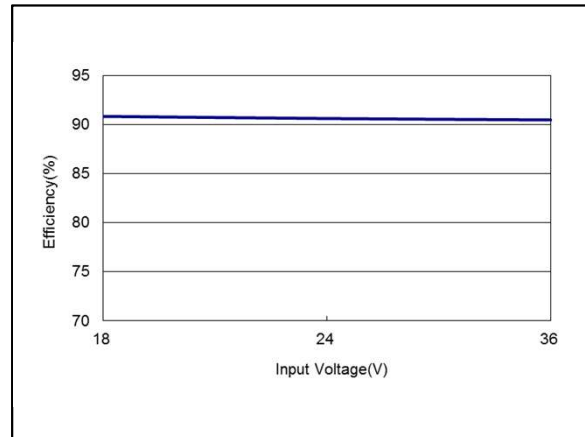

Figure 44: AEE02B24-M Efficiency Versus Input Voltage Curve
 Vin = 18 to 36Vdc Load: Io = 1.67A

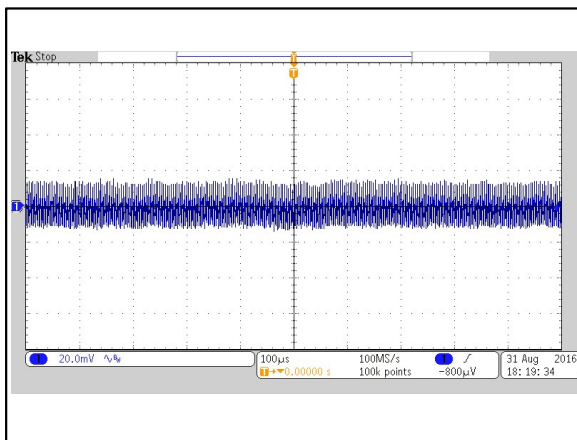

Figure 45: AEE02B24-M Ripple and Noise Measurement
 Vin = 24Vdc Load: Io = 1.67A
 Ch 1: Vo

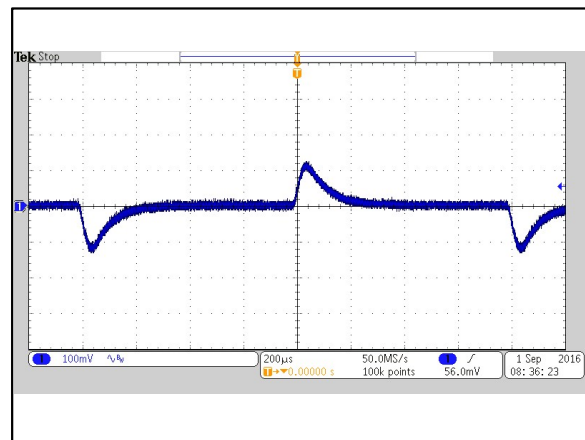

Figure 46: AEE02B24-M Transient Response
 Vin = 24Vdc Load: Io = 100% to 75% load change
 Ch 1: Vo

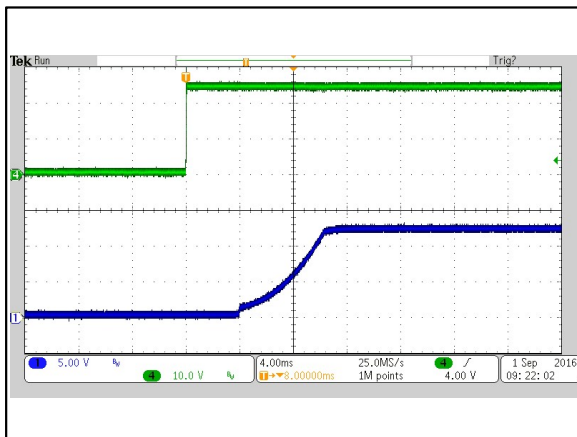

Figure 47: AEE02B24-M Output Voltage Startup Characteristic by Vin
 Vin = 24Vdc Load: Io = 1.67A
 Ch 1: Vo Ch 4: Vin

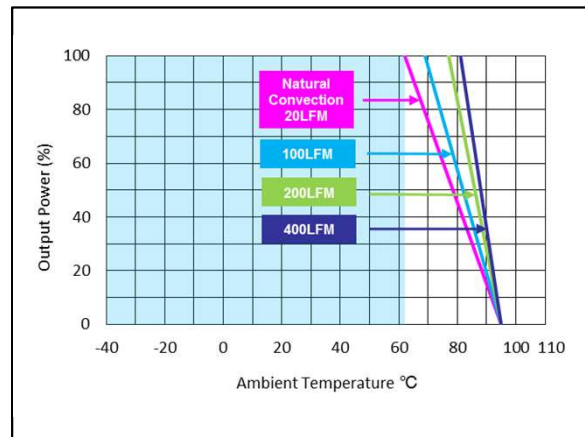

Figure 48: AEE02B24-M Derating Output Current vs Ambient Temp.
 Vin = 24Vdc Load: Io = 1.67A

Electrical Specifications

AEE02C24-M Performance Curves

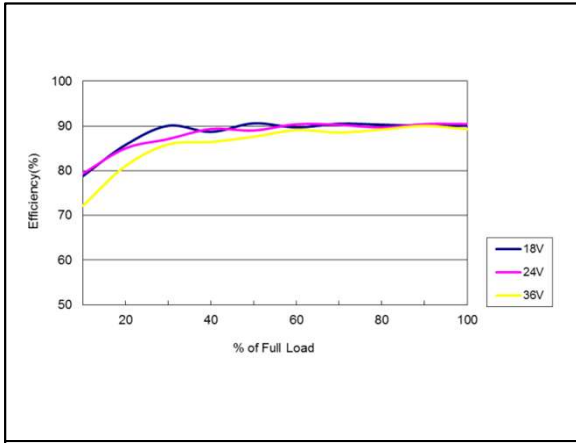

Figure 49: AEE02C24-M Efficiency Versus Output Current Curve
 Vin = 18 to 36Vdc Load: Io = 0 to 1.33A

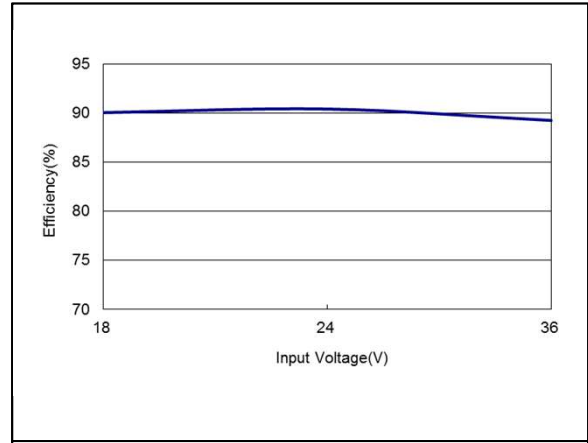

Figure 50: AEE02C24-M Efficiency Versus Input Voltage Curve
 Vin = 18 to 36Vdc Load: Io = 1.33A

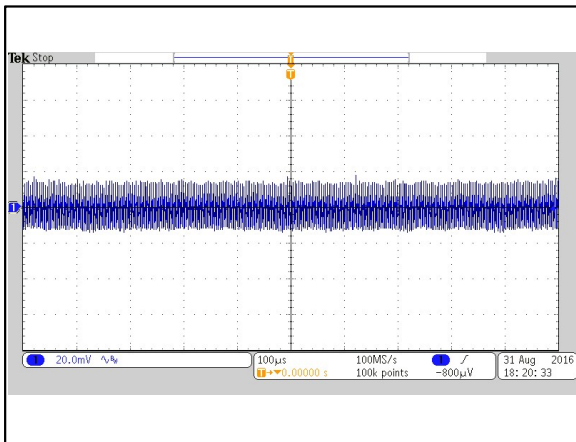

Figure 51: AEE02C24-M Ripple and Noise Measurement
 Vin = 24Vdc Load: Io = 1.33A
 Ch 1: Vo

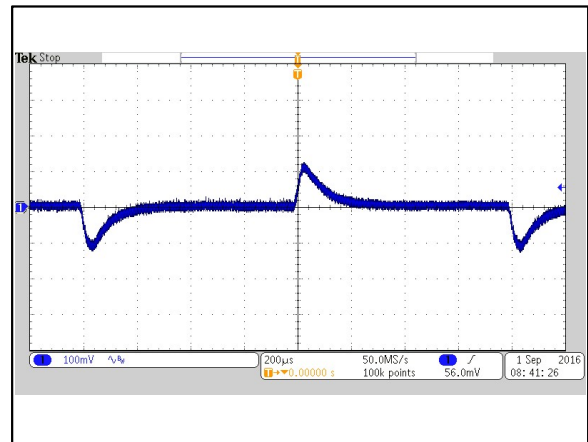

Figure 52: AEE02C24-M Transient Response
 Vin = 24Vdc Load: Io = 100% to 75% load change
 Ch 1: Vo

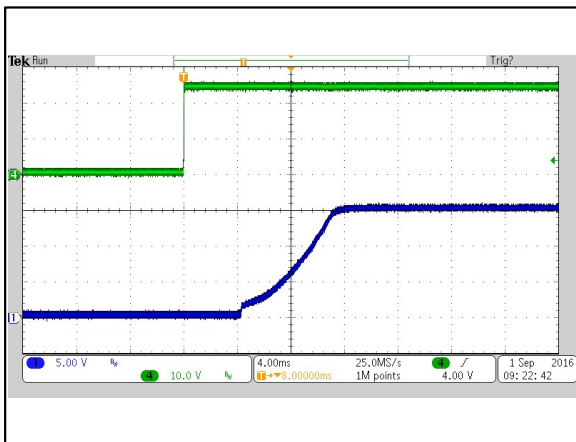

Figure 53: AEE02C24-M Output Voltage Startup Characteristic by Vin
 Vin = 24Vdc Load: Io = 1.33A
 Ch 1: Vo Ch 4: Vin

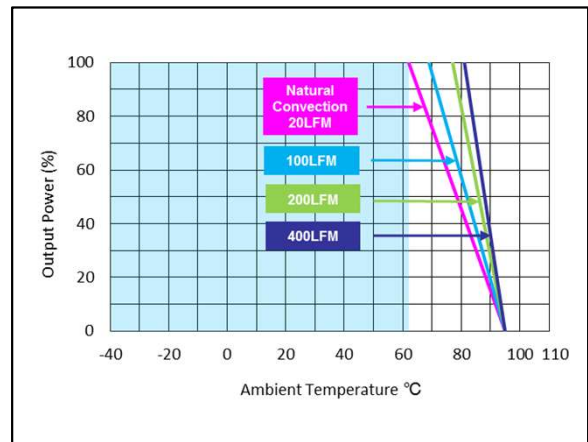

Figure 54: AEE02C24-M Derating Output Current vs Ambient Temp.
 Vin = 24Vdc Load: Io = 1.33A

Electrical Specifications

AEE02H24-M Performance Curves

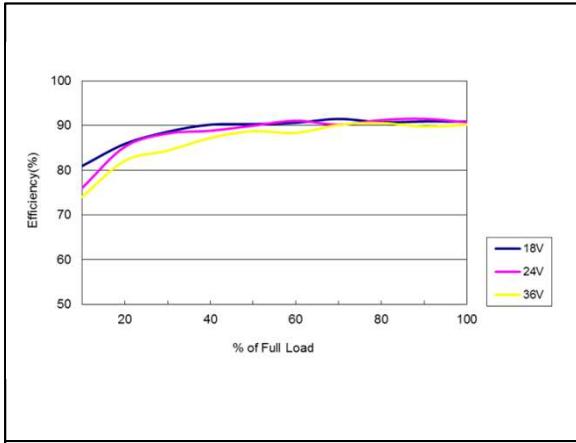

Figure 55: AEE02H24-M Efficiency Versus Output Current Curve
 Vin = 18 to 36Vdc Load: Io = 0 to 0.84A

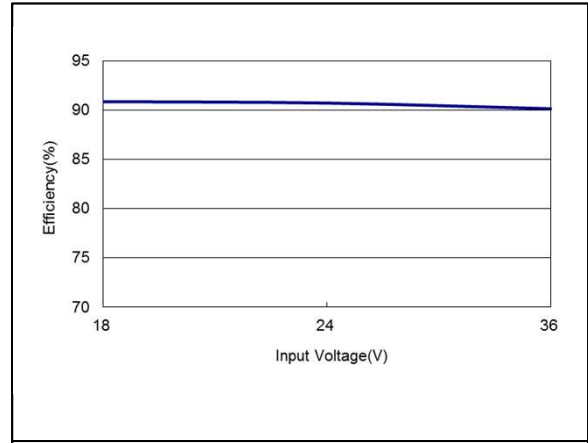

Figure 56: AEE02H24-M Efficiency Versus Input Voltage Curve
 Vin = 18 to 36Vdc Load: Io = 0.84A

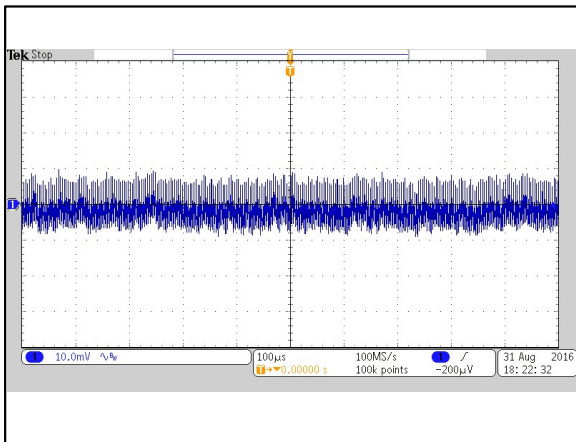

Figure 57: AEE02H24-M Ripple and Noise Measurement
 Vin = 24Vdc Load: Io = 0.84A
 Ch 1: Vo

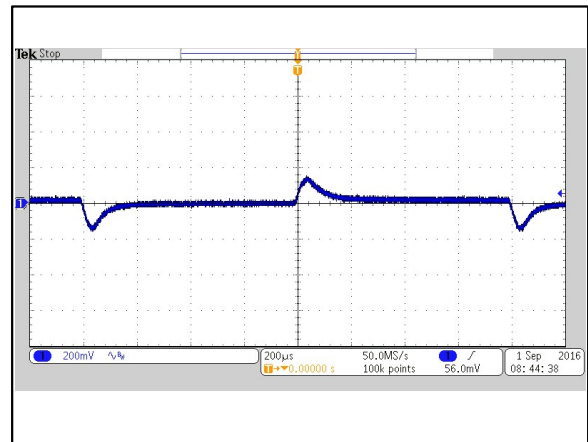

Figure 58: AEE02H24-M Transient Response
 Vin = 24Vdc Load: Io = 100% to 75% load change
 Ch 1: Vo

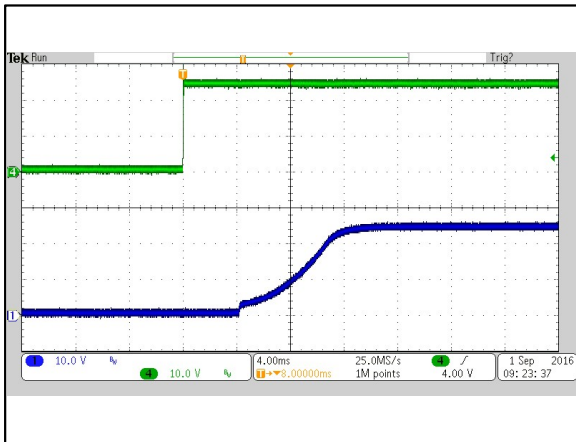

Figure 59: AEE02H24-M Output Voltage Startup Characteristic by Vin
 Vin = 24Vdc Load: Io = 0.84A
 Ch 1: Vo Ch 4: Vin

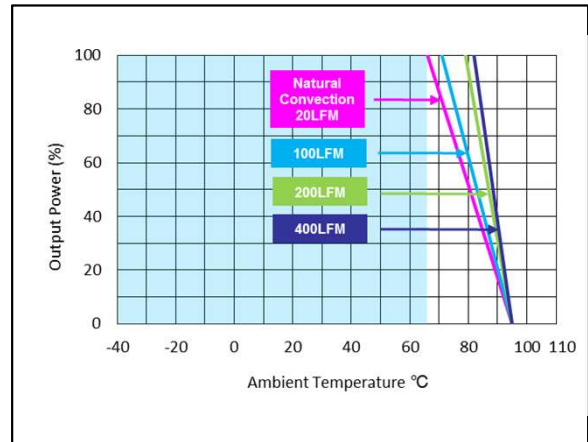

Figure 60: AEE02H24-M Derating Output Current vs Ambient Temp.
 Vin = 24Vdc Load: Io = 0.84A

Electrical Specifications

AEE02BB24-M Performance Curves

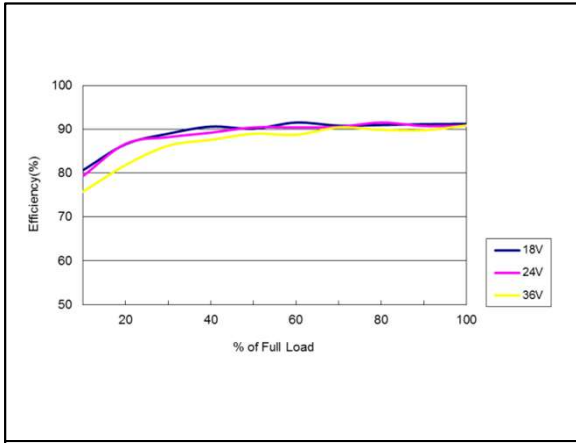

Figure 61: AEE02BB24-M Efficiency Versus Output Current Curve
 Vin = 18 to 36Vdc Load: Io = 0 to ±0.84A

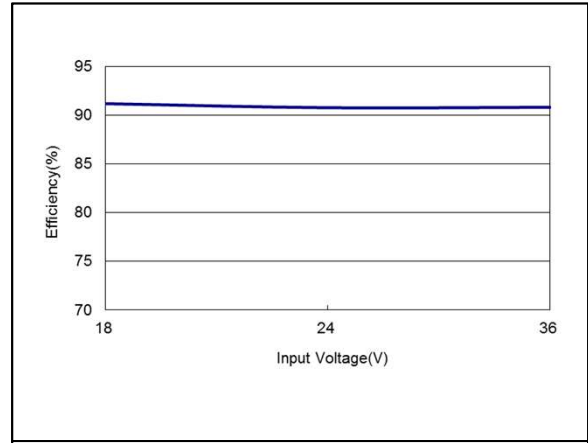

Figure 62: AEE02BB24-M Efficiency Versus Input Voltage Curve
 Vin = 18 to 36Vdc Load: Io = ±0.84A

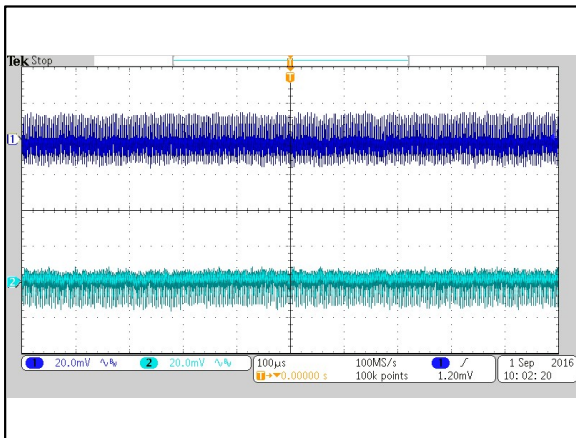

Figure 63: AEE02BB24-M Ripple and Noise Measurement
 Vin = 24Vdc Load: Io = ±0.84A
 Ch 1: Vo1 Ch 2: Vo2

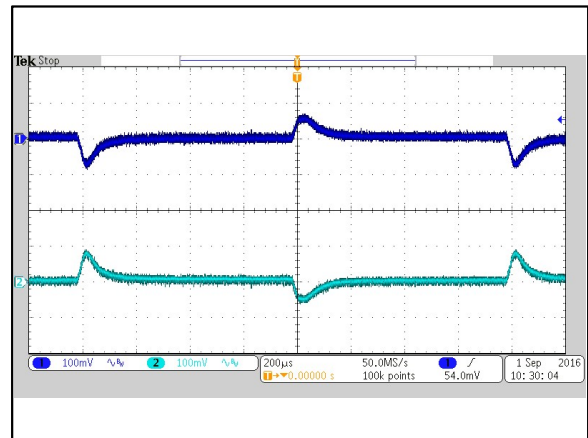

Figure 64: AEE02BB24-M Transient Response
 Vin = 24Vdc Load: Io = 100% to 75% load change
 Ch 1: Vo1 Ch 2: Vo2

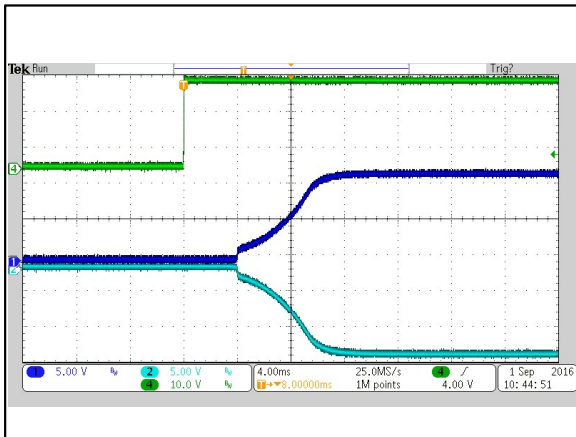

Figure 65: AEE02BB24-M Output Voltage Startup Characteristic by Vin
 Vin = 24Vdc Load: Io = ±0.84A
 Ch 1: Vo Ch 4: Vin

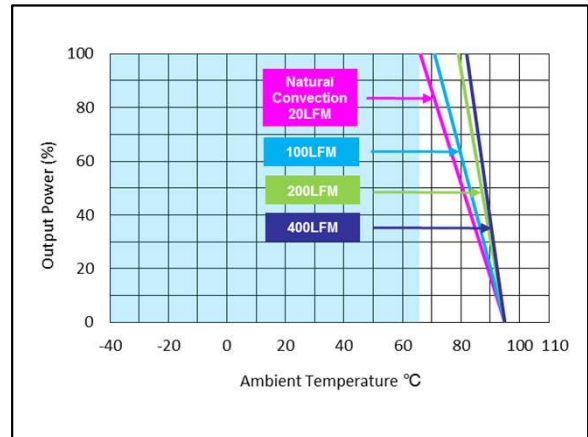

Figure 66: AEE02BB24-M Derating Output Current vs Ambient Temp.
 Vin = 24Vdc Load: Io = ±0.84A

Electrical Specifications

AEE02CC24-M Performance Curves

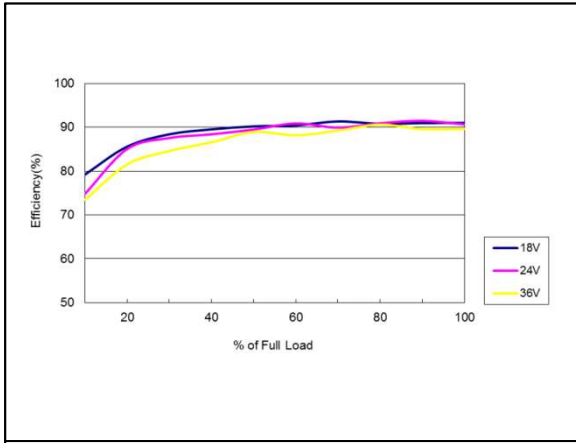

Figure 67: AEE02CC24-M Efficiency Versus Output Current Curve
 Vin = 18 to 36Vdc Load: Io = 0 to ±0.67A

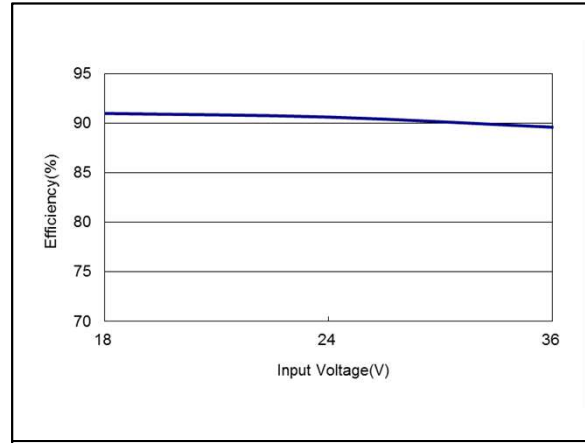

Figure 68: AEE02CC24-M Efficiency Versus Input Voltage Curve
 Vin = 18 to 36Vdc Load: Io = ±0.67A

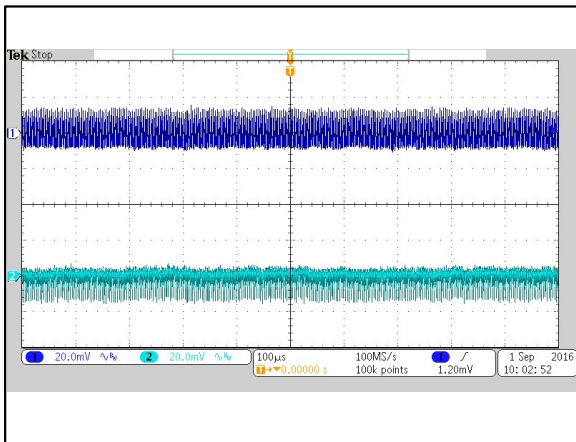

Figure 69: AEE02CC24-M Ripple and Noise Measurement
 Vin = 24Vdc Load: Io = ±0.67A
 Ch 1: Vo1 Ch 2: Vo2

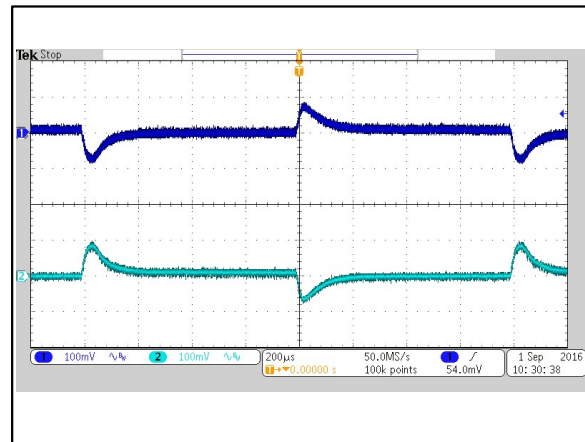

Figure 70: AEE02CC24-M Transient Response
 Vin = 24Vdc Load: Io = 100% to 75% load change
 Ch 1: Vo1 Ch 2: Vo2

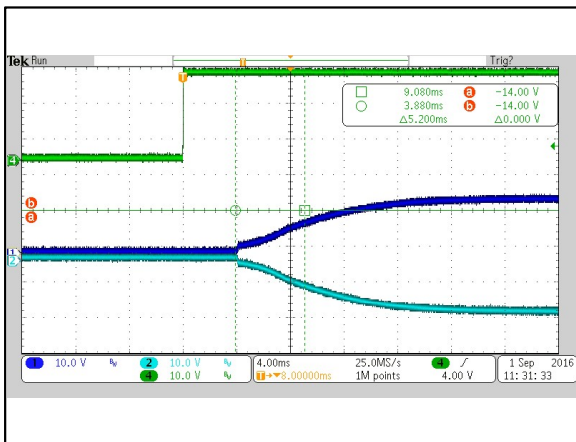

Figure 71: AEE02CC24-M Output Voltage Startup Characteristic by Vin
 Vin = 24Vdc Load: Io = ±0.67A
 Ch 1: Vo Ch 4: Vin

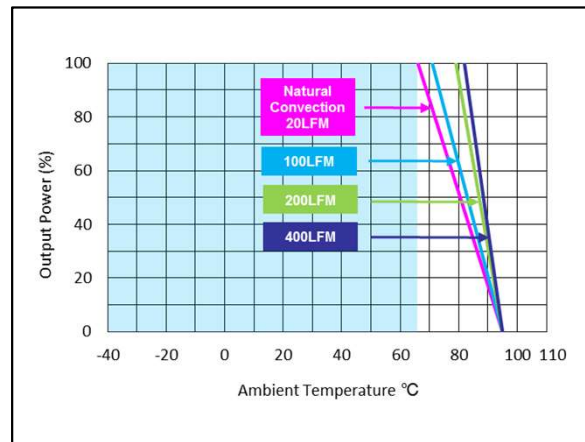

Figure 72: AEE02CC24-M Derating Output Current vs Ambient Temp.
 Vin = 24Vdc Load: Io = ±0.67A

Electrical Specifications

AEE04A48-M Performance Curves

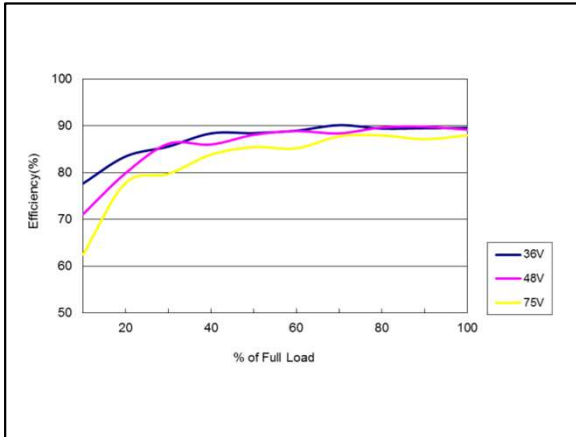

Figure 73: AEE04A48-M Efficiency Versus Output Current Curve
 Vin = 36 to 75Vdc Load: Io = 0 to 4A

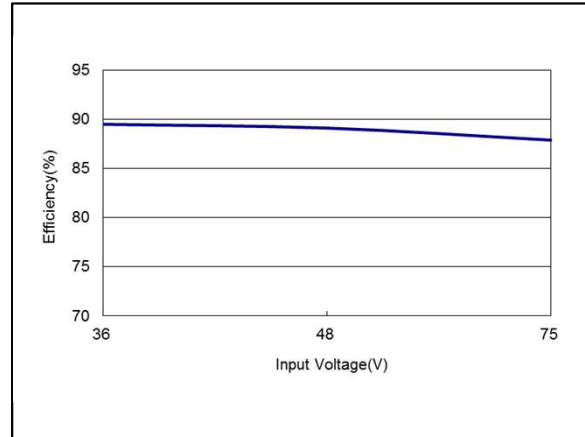

Figure 74: AEE04A48-M Efficiency Versus Input Voltage Curve
 Vin = 36 to 75Vdc Load: Io = 4A

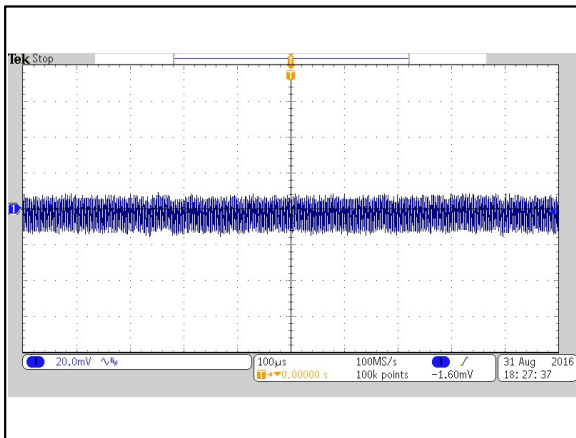

Figure 75: AEE04A48-M Ripple and Noise Measurement
 Vin = 48Vdc Load: Io = 4A
 Ch 1: Vo

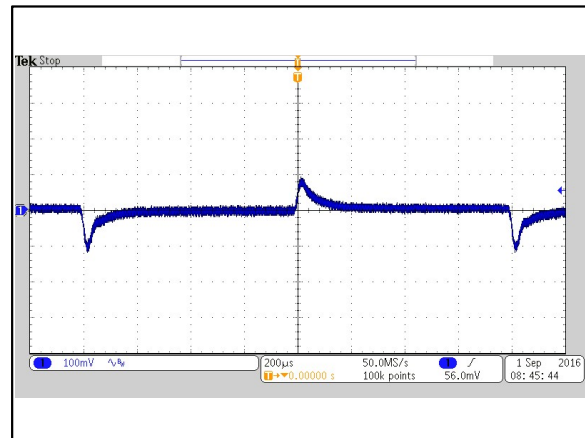

Figure 76: AEE04A48-M Transient Response
 Vin = 48Vdc Load: Io = 100% to 75% load change
 Ch 1: Vo

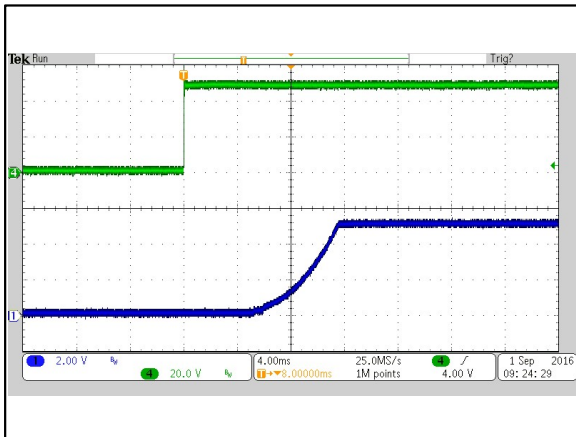

Figure 77: AEE04A48-M Output Voltage Startup Characteristic by Vin
 Vin = 48Vdc Load: Io = 4A
 Ch 1: Vo Ch 4: Vin

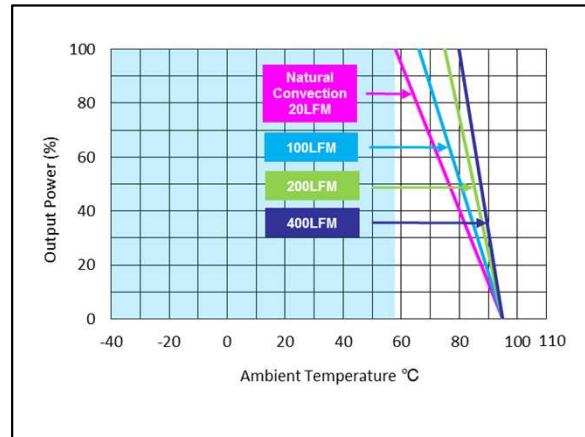

Figure 78: AEE04A48-M Derating Output Current vs Ambient Temp.
 Vin = 48Vdc Load: Io = 4A

Electrical Specifications

AEE02B48-M Performance Curves

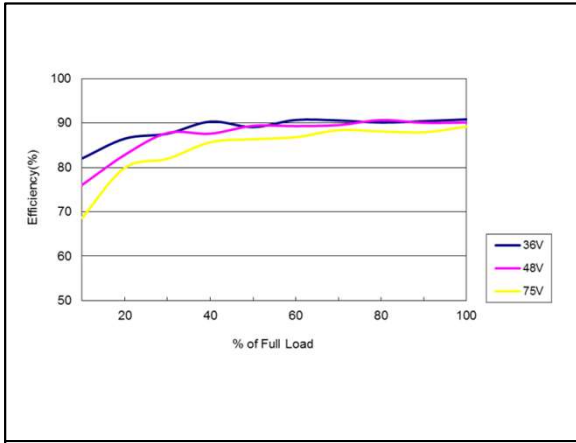

Figure 79: AEE02B48-M Efficiency Versus Output Current Curve
 Vin = 36 to 75Vdc Load: Io = 0 to 1.67A

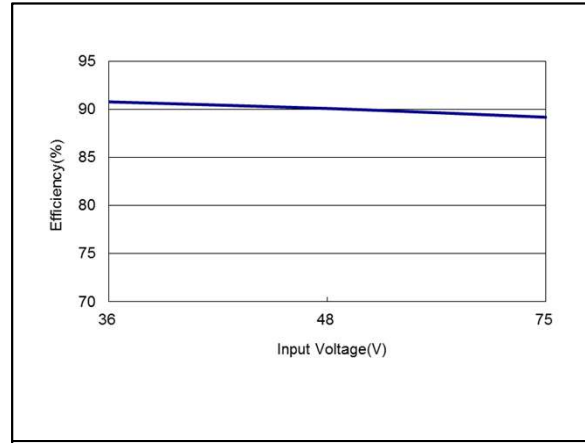

Figure 80: AEE02B48-M Efficiency Versus Input Voltage Curve
 Vin = 36 to 75Vdc Load: Io = 1.67A

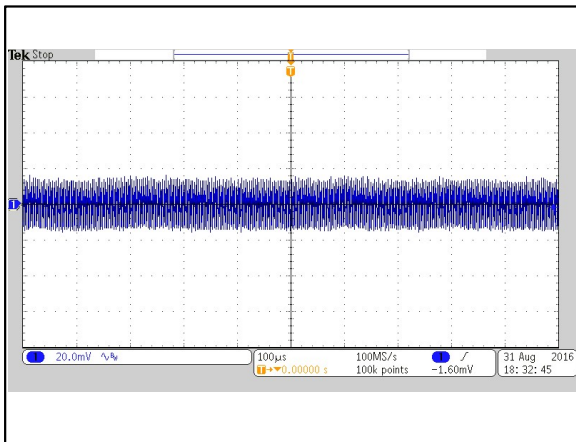

Figure 81: AEE02B48-M Ripple and Noise Measurement
 Vin = 48Vdc Load: Io = 1.67A
 Ch 1: Vo

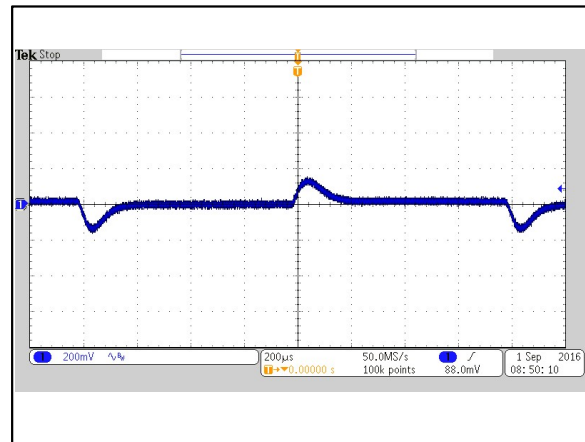

Figure 82: AEE02B48-M Transient Response
 Vin = 48Vdc Load: Io = 100% to 75% load change
 Ch 1: Vo

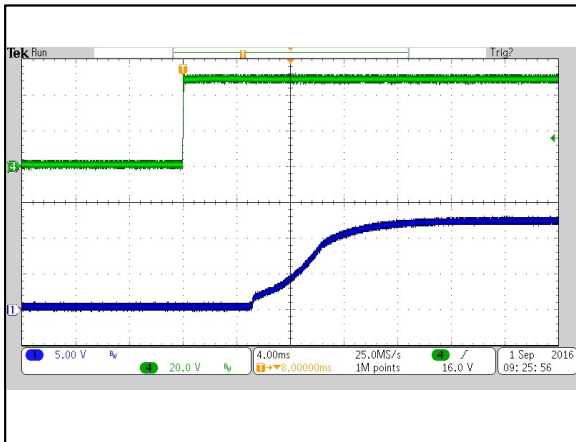

Figure 83: AEE02B48-M Output Voltage Startup Characteristic by Vin
 Vin = 48Vdc Load: Io = 1.67A
 Ch 1: Vo Ch 4: Vin

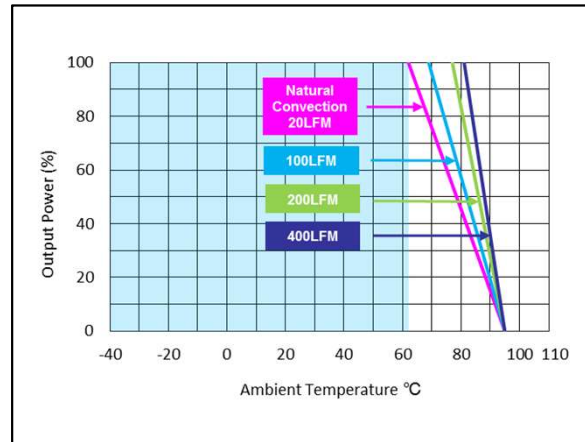

Figure 84: AEE02B48-M Derating Output Current vs Ambient Temp.
 Vin = 48Vdc Load: Io = 1.67A

Electrical Specifications

AEE02C48-M Performance Curves

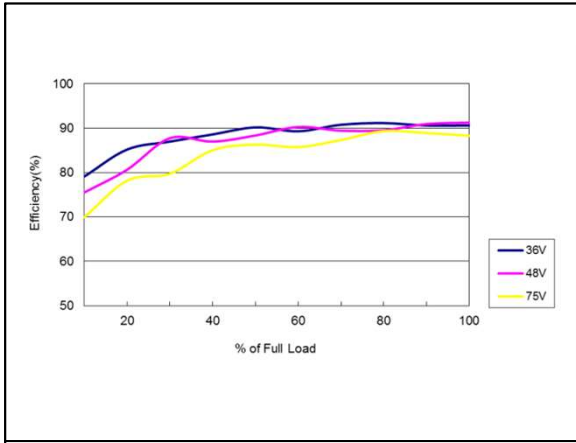

Figure 85: AEE02C48-M Efficiency Versus Output Current Curve
 Vin = 36 to 75Vdc Load: Io = 0 to 1.33A

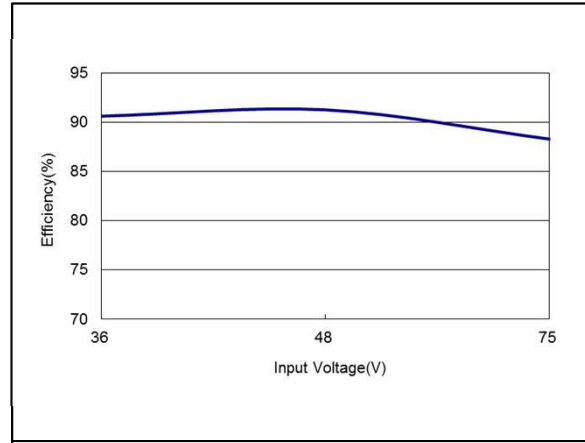

Figure 86: AEE02C48-M Efficiency Versus Input Voltage Curve
 Vin = 36 to 75Vdc Load: Io = 1.33A

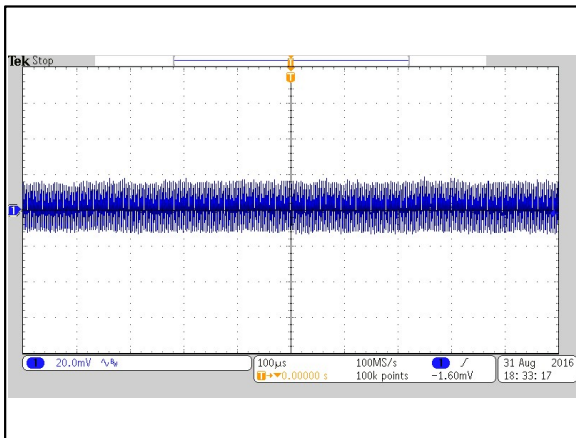

Figure 87: AEE02C48-M Ripple and Noise Measurement
 Vin = 48Vdc Load: Io = 1.33A
 Ch 1: Vo

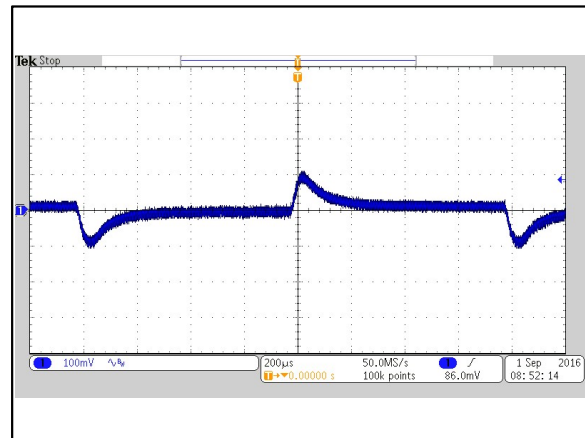

Figure 88: AEE02C48-M Transient Response
 Vin = 48Vdc Load: Io = 100% to 75% load change
 Ch 1: Vo

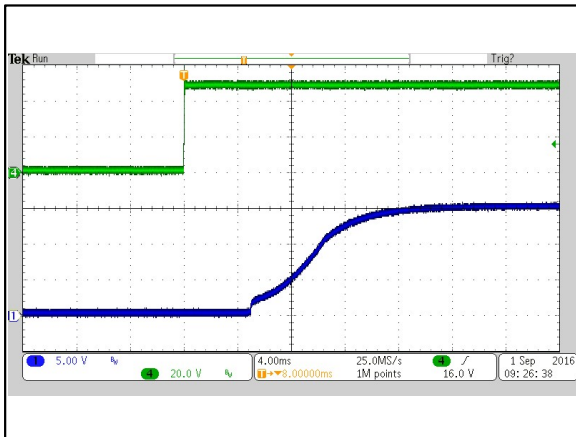

Figure 89: AEE02C48-M Output Voltage Startup Characteristic by Vin
 Vin = 48Vdc Load: Io = 1.33A
 Ch 1: Vo Ch 4: Vin

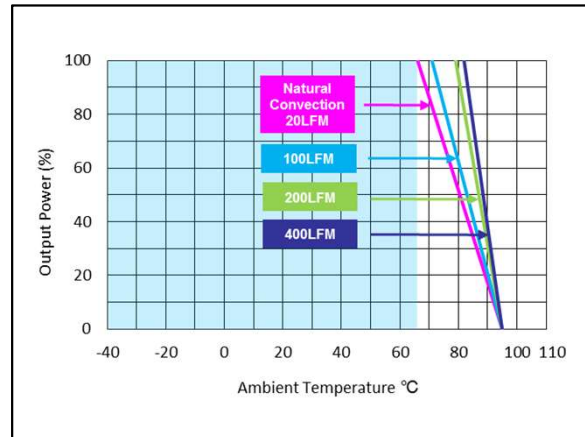

Figure 90: AEE02C48-M Derating Output Current vs Ambient Temp.
 Vin = 48Vdc Load: Io = 1.33A

Electrical Specifications

AEE02H48-M Performance Curves

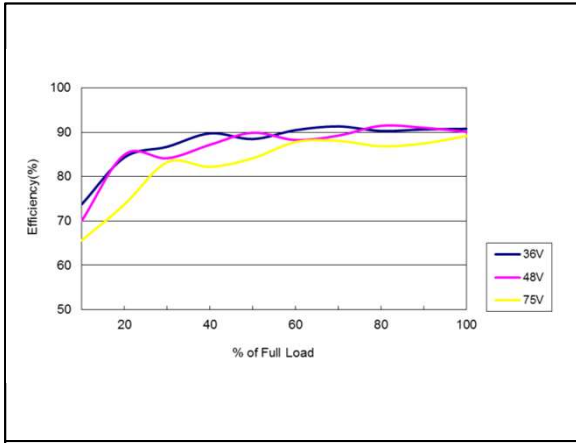

Figure 91: AEE02H48-M Efficiency Versus Output Current Curve
 Vin = 36 to 75Vdc Load: Io = 0 to 0.84A

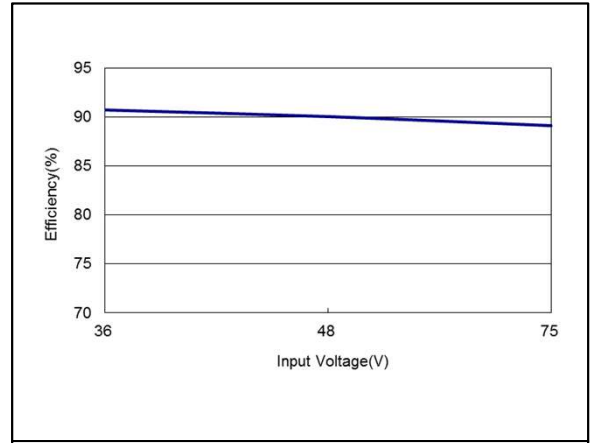

Figure 92: AEE02H48-M Efficiency Versus Input Voltage Curve
 Vin = 36 to 75Vdc Load: Io = 0.84A

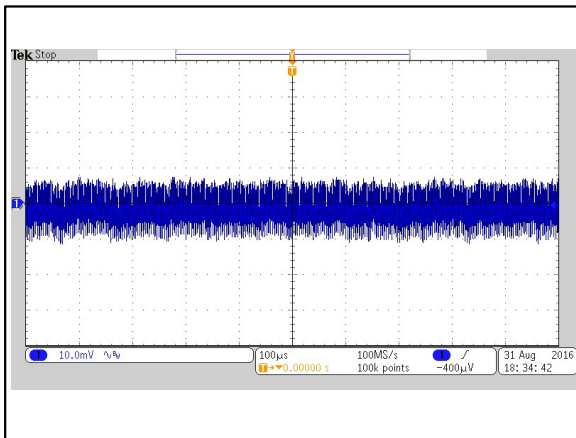

Figure 93: AEE02H48-M Ripple and Noise Measurement
 Vin = 48Vdc Load: Io = 0.84A
 Ch 1: Vo

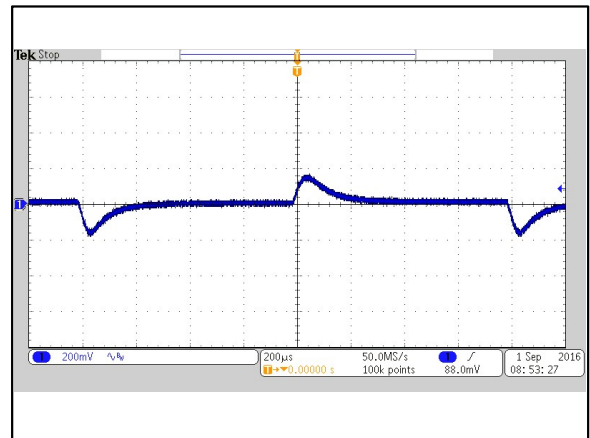

Figure 94: AEE02H48-M Transient Response
 Vin = 48Vdc Load: Io = 100% to 75% load change
 Ch 1: Vo

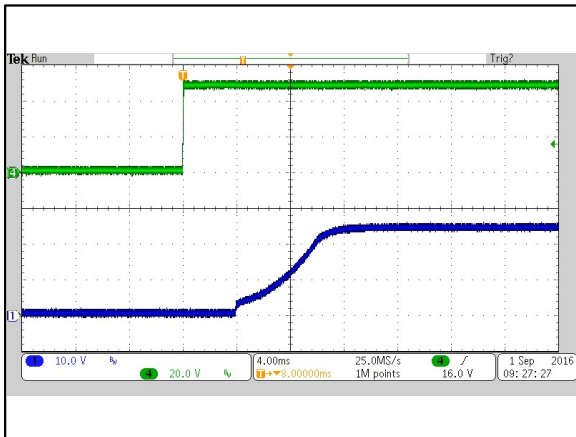

Figure 95: AEE02H48-M Output Voltage Startup Characteristic by Vin
 Vin = 48Vdc Load: Io = 0.84A
 Ch 1: Vo Ch 4: Vin

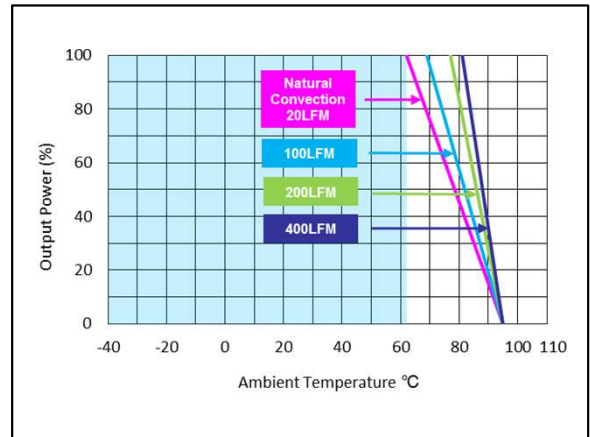

Figure 96: AEE02H48-M Derating Output Current vs Ambient Temp.
 Vin = 48Vdc Load: Io = 0.84A

Electrical Specifications

AEE02BB48-M Performance Curves

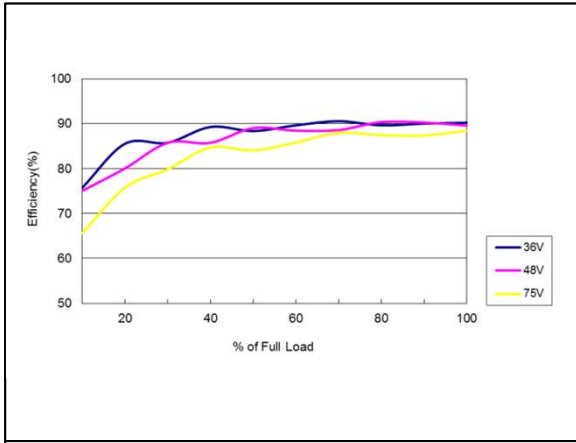

Figure 97: AEE02BB48-M Efficiency Versus Output Current Curve
 Vin = 36 to 75Vdc Load: Io = 0 to ±0.84A

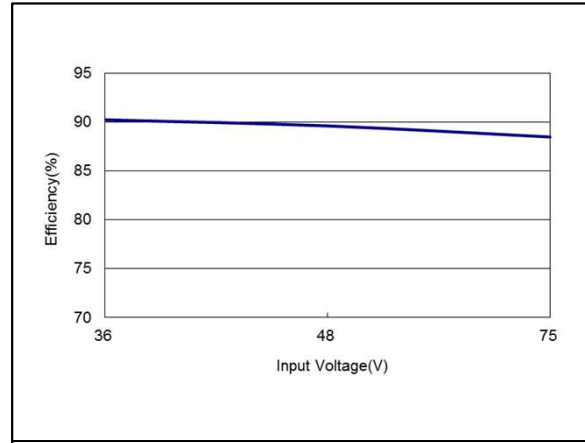

Figure 98: AEE02BB48-M Efficiency Versus Input Voltage Curve
 Vin = 36 to 75Vdc Load: Io = ±0.84A

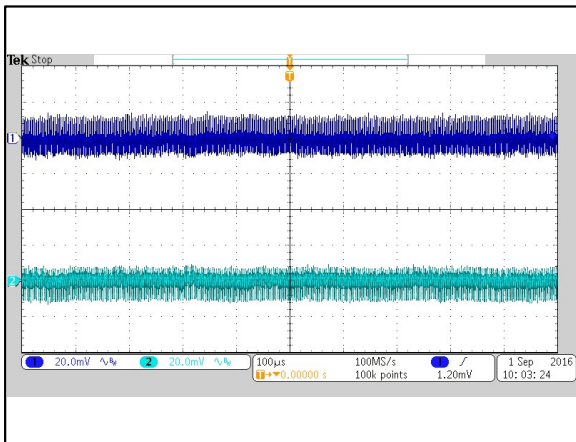

Figure 99: AEE02BB48-M Ripple and Noise Measurement
 Vin = 48Vdc Load: Io = ±0.84A
 Ch 1: Vo1 Ch 1: Vo2

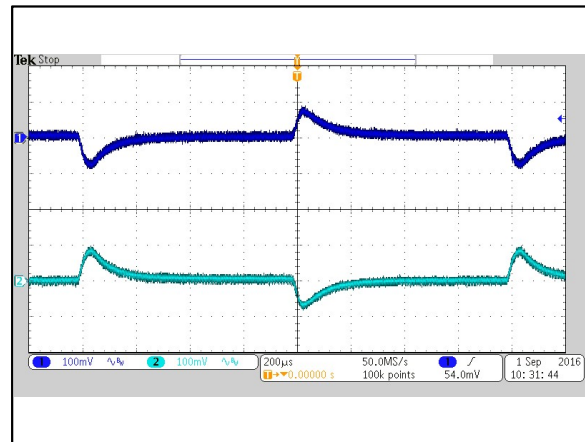

Figure 100: AEE02BB48-M Transient Response
 Vin = 48Vdc Load: Io = 100% to 75% load change
 Ch 1: Vo1 Ch 1: Vo2

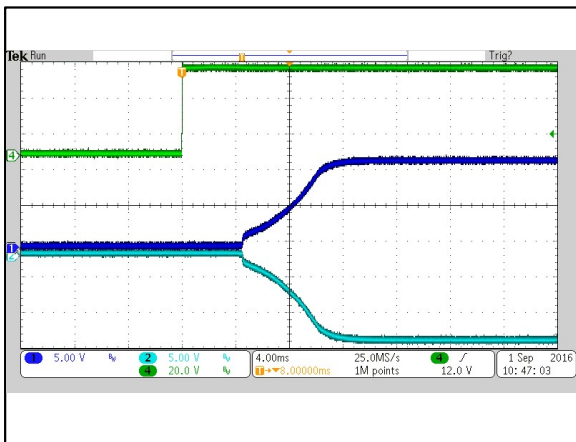

Figure 101: AEE02BB48-M Output Voltage Startup Characteristic by Vin
 Vin = 48Vdc Load: Io = ±0.84A
 Ch 1: Vo Ch 4: Vin

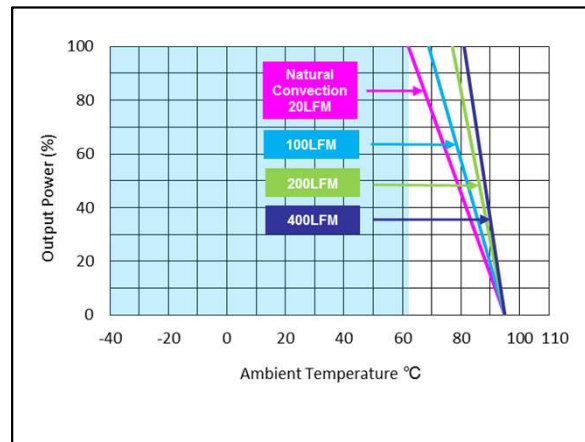

Figure 102: AEE02BB48-M Derating Output Current vs Ambient Temp.
 Vin = 48Vdc Load: Io = ±0.84A

Electrical Specifications

AEE02CC48-M Performance Curves

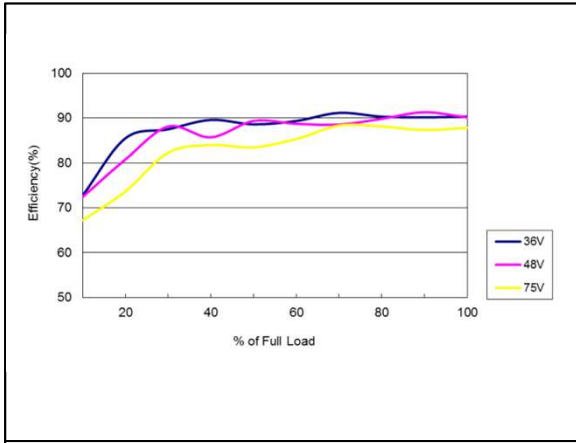

Figure 103: AEE02CC48-M Efficiency Versus Output Current Curve
 Vin = 36 to 75Vdc Load: Io = 0 to ±0.67A

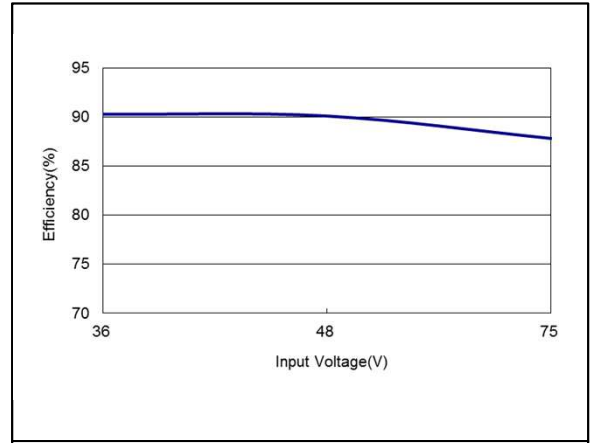

Figure 104: AEE02CC48-M Efficiency Versus Input Voltage Curve
 Vin = 36 to 75Vdc Load: Io = ±0.67A

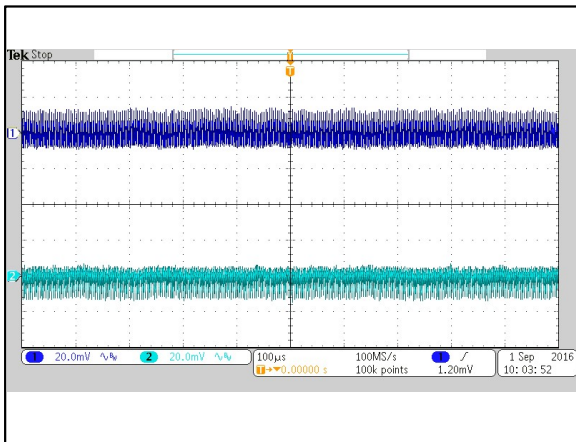

Figure 105: AEE02CC48-M Ripple and Noise Measurement
 Vin = 48Vdc Load: Io = ±0.67A
 Ch 1: Vo1 Ch 1: Vo2

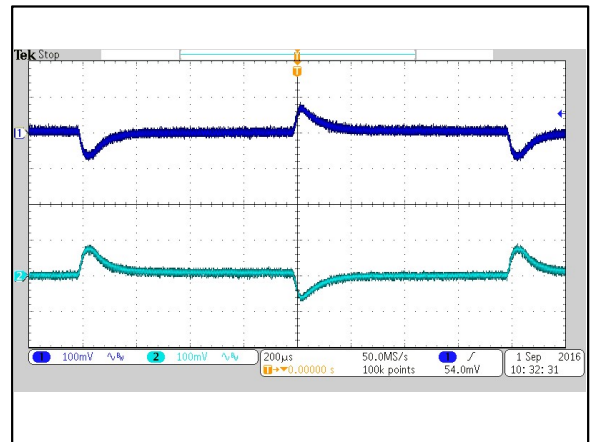

Figure 106: AEE02CC48-M Transient Response
 Vin = 48Vdc Load: Io = 100% to 75% load change
 Ch 1: Vo1 Ch 1: Vo2

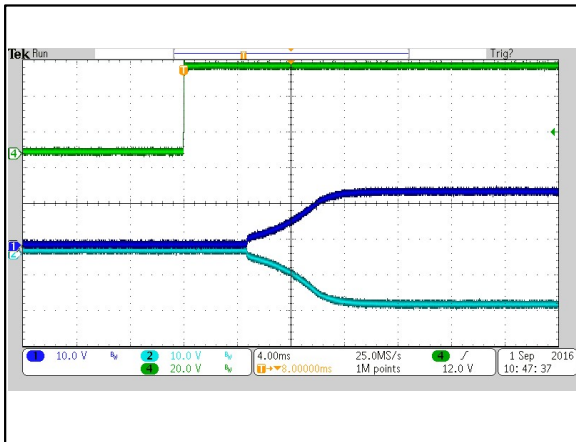

Figure 107: AEE02CC48-M Output Voltage Startup Characteristic by Vin
 Vin = 48Vdc Load: Io = ±0.67A
 Ch 1: Vo Ch 4: Vin

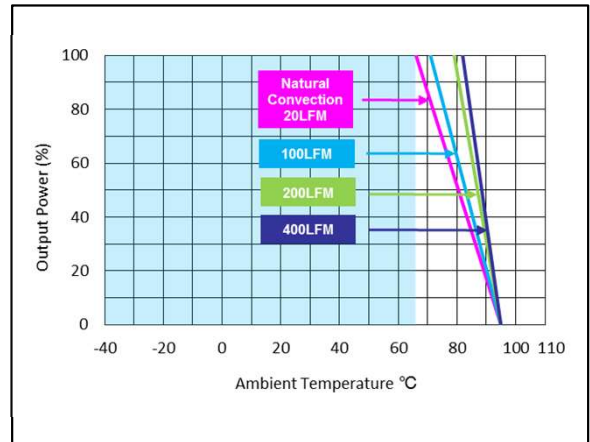
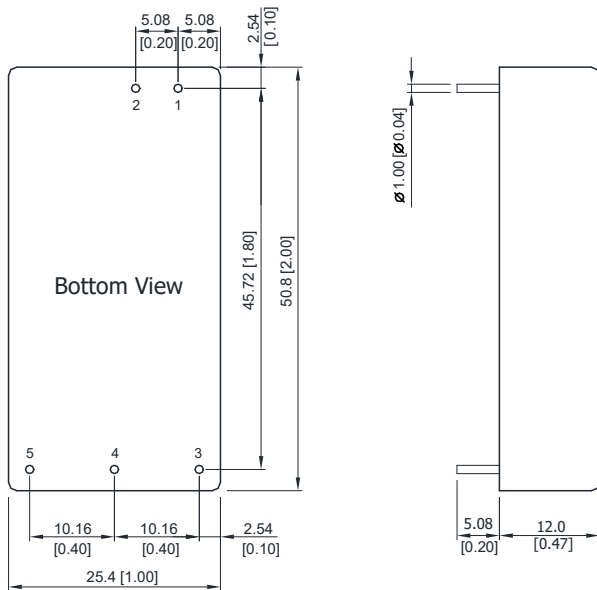

Figure 108: AEE02CC48-M Derating Output Current vs Ambient Temp.
 Vin = 48Vdc Load: Io = ±0.67A

Mechanical Specifications

Mechanical Outlines (unit: mm)



Note:

- 1.All dimensions in mm (inches)
- 2.Tolerance: X.X±0.5 (X.XX±0.02)
X.XX±0.25 (X.XXX±0.01)
- 3.Pin diameter: 1.0 ±0.05 (0.04±0.002)

Pin Connections

Single output

- Pin 1 - +Vin
- Pin 2 - -Vin
- Pin 3 - +Vout
- Pin 4 - No Pin
- Pin 5 - -Vout

Dual Output

- Pin 1 - +Vin
- Pin 2 - -Vin
- Pin 3 - +Vout
- Pin 4 - Common
- Pin 5 - -Vout

Physical Characteristics

Case Size	50.8x25.4x12.0mm (2.0x1.0x0.47 inches)
Case Material	Non-Conductive Black Plastic (flammability to UL 94V-0 rated)
Pin Material	Tinned Copper
Weight	30g

Mechanical Specifications

Recommended Pad Layout

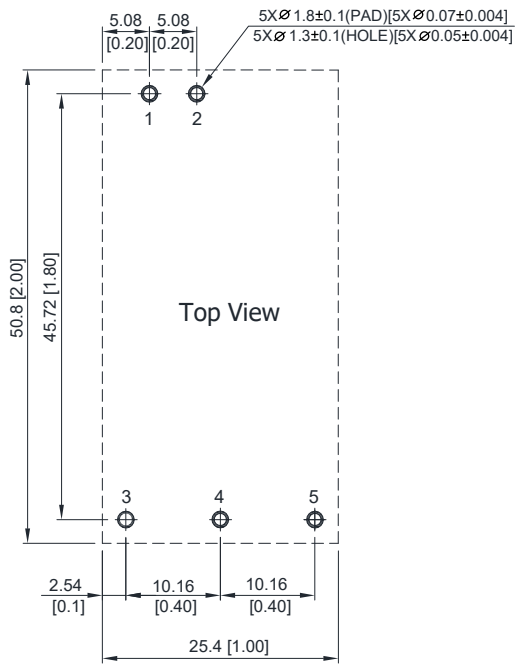

Environmental Specifications

EMC Immunity

AEE20W-M series power supply is designed to meet the following EMC immunity specifications.

Table 4. EMC Specifications			
Parameter	Standards & Level		Performance
EMI	Conduction & Radiation	EN55011, FCC part15	Class A
EMS	EN60601-1-2 4 th		
	ESD	EN61000-4-2 Air ± 15 kV, Contact ± 8 kV	Perf. Criteria A
	Radiated immunity	EN61000-4-3 10V/m	
	Fast transient ¹	EN61000-4-4 ± 2 KV	Perf. Criteria A
	Surge ¹	EN61000-4-5 ± 1 KV	Perf. Criteria A
	Conducted immunity	EN61000-4-6 10Vrms	Perf. Criteria A
	PfMF	EN61000-4-8 30A/M	Perf. Criteria A

Note 1: To meet EN61000-4-4 & EN61000-4-5, an external capacitor across the input pins is required. Suggested capacitor : 330 μ F/100V.

Environmental Specifications

Safety Certifications

The AEE20W-M series power supply is intended for inclusion in other equipment and the installer must ensure that it is in compliance with all the requirements of the end application. This product is only for inclusion by professional installers within other equipment and must not be operated as a stand alone product.

Table 5. Safety Certifications for AEE10W-M series power supply system	
Document	Description
cUL/UL 60950-1 (CSA certificate)	US and Canada Requirements
IEC/EN 60950-1 (CB-scheme)	European Requirements (All CENELEC Countries)
UL60601-1	US Medical Requirements
IEC/EN 60950-1, IEC/EN 60601-1 3rd Edition, 2 MOPP	International and European Medical Requirements

Environmental Specifications

Operating Temperature

Table 6. Operating Temperature				
Parameter	Model / Condition	Min	Max	Unit
Operating Temperature Range (Natural Convection ¹ , See Derating)	AEE02H24-M AEE02BB24-M AEE02CC24-M AEE02C48-M AEE02CC48-M	-40	66	°C
	AEE02B12-M AEE02H12-M AEE02BB12-M AEE02CC12-M AEE02B24-M AEE02C24-M AEE02B48-M AEE02H48-M AEE02BB48-M		62	
	AEE02C12-M AEE04A24-M AEE04A48-M		58	
	AEE04A12-M		51	
Operating Case Temperature	All	-	+95	°C
Storage Temperature Range		-50	+125	°C
Humidity (non condensing)		-	95	%
Altitude		-	4000	m
Cooling	Free-Air convection			
Lead Temperature (1.5mm from case for 10Sec.)		-	260	°C

Note1 - The "natural convection" is about 20LFM but is not equal to still air (0 LFM).

Environmental Specifications

MTBF and Reliability

The MTBF of AEE20W-M series of DC/DC converters has been calculated using MIL-HDBK 217F NOTICE2, Operating Temperature 25 °C, Ground Benign.

Model	MTBF	Unit
AEE04A12-M	1087344	Hours
AEE02B12-M	1598916	
AEE02C12-M	1655302	
AEE02H12-M	1565185	
AEE02BB12-M	1565185	
AEE02CC12-M	1758649	
AEE04A24-M	1308922	
AEE02B24-M	1639993	
AEE02C24-M	1691078	
AEE02H24-M	1708823	
AEE02BB24-M	1708823	
AEE02CC24-M	1780647	
AEE04A48-M	1419400	
AEE02B48-M	1641012	
AEE02C48-M	1692282	
AEE02H48-M	1474814	
AEE02BB48-M	1474814	
AEE02CC48-M	1793561	

Application Notes

Input Reflected-Ripple Current Test Setup

Input reflected-ripple current is measured with an inductor L_{in} ($4.7\mu\text{H}$) and C_{in} ($220\mu\text{F}$, $\text{ESR} < 1.0\Omega$ at 100 KHz) to simulate source impedance. Capacitor C_{in} , offsets possible battery impedance. Current ripple is measured at the input terminals of the module, measurement bandwidth is $0\text{-}500\text{ KHz}$.

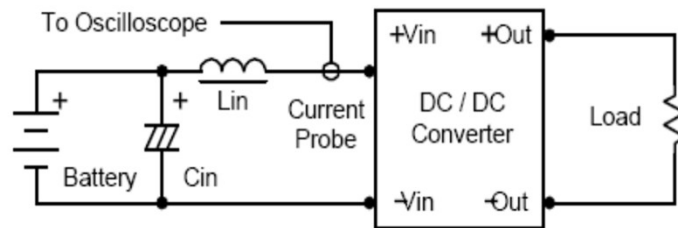

Component	Value	Reference
L_{in}	$4.7\mu\text{H}$	-
C_{in}	$220\mu\text{F}$ ($\text{ESR} < 1.0\Omega$ at 100KHz)	Aluminum Electrolytic Capacitor

Application Notes

Output Ripple Reduction

A good quality low ESR capacitor placed as close as practicable across the load will give the best ripple and noise performance. To reduce output ripple, it is recommended to use 4.7uF capacitors at the output.

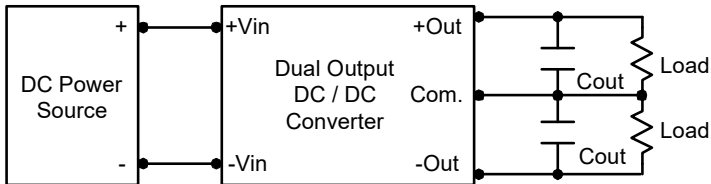
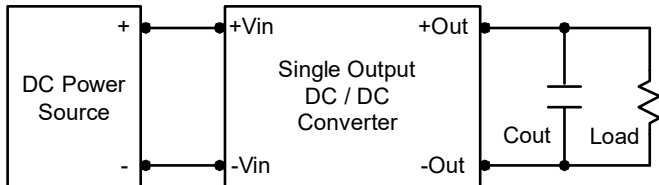

Peak-to-Peak Output Noise Measurement Test

Use a Cout 0.47uF ceramic capacitor. Scope measurement should be made by using a BNC socket, measurement bandwidth is 0-20MHz. Position the load between 50 mm and 75 mm from the DC/DC Converter.

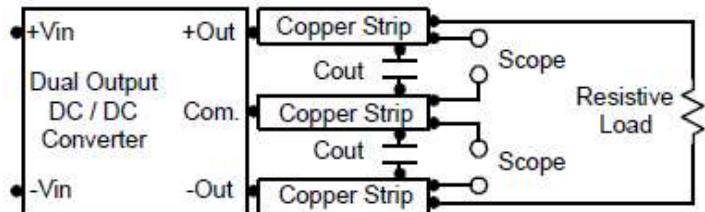
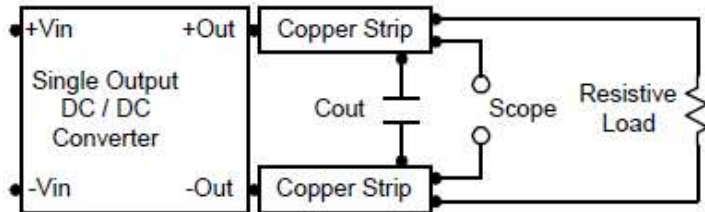

Application Notes

Input Source Impedance

The power module should be connected to a low ac-impedance input source. Highly inductive source impedances can affect the stability of the power module. In applications where power is supplied over long lines and output loading is high, it may be necessary to use a capacitor at the input to ensure startup. By using a good quality low Equivalent Series Resistance ($ESR < 1.0\Omega$ at 100 kHz) capacitor of a $10\mu\text{F}$ for the 12V input devices and a $4.7\mu\text{F}$ for the 24V input devices and a $2.2\mu\text{F}$ for the 48V devices, capacitor mounted close to the power module helps ensure stability of the unit.

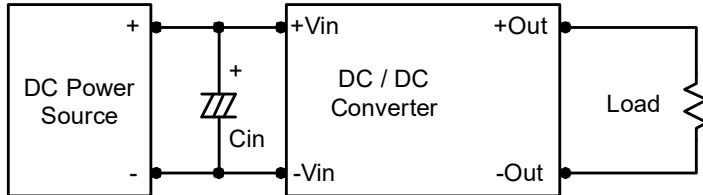

Output Over Current Protection

To provide hiccup mode protection in a fault (output overload) condition, the unit is equipped with internal current limiting circuitry and can endure overload for an unlimited duration.

Output Over Voltage Protection

The output overvoltage clamp consists of control circuitry, which is independent of the primary regulation loop, that monitors the voltage on the output terminals.

The control loop of the clamp has a higher voltage set point than the primary loop. This provides a redundant voltage control that reduces the risk of output overvoltage. The OVP level can be found in the output data.

Thermal Considerations

Many conditions affect the thermal performance of the power module, such as orientation, airflow over the module and board spacing. To avoid exceeding the maximum temperature rating of the components inside the power module, the case temperature must be kept below $95\text{ }^{\circ}\text{C}$. The derating curves are determined from measurements obtained in a test setup.

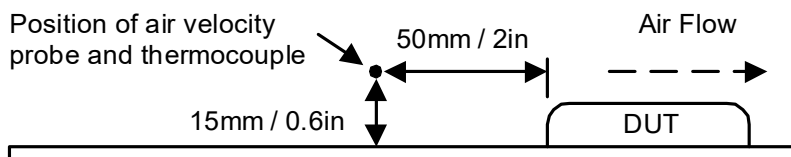

Maximum Capacitive Load

The AEE20W-M series has limitation of maximum connected capacitance at the output. The power module may operate in current limiting mode during start-up, affecting the ramp-up and the startup time. The maximum capacitance can be found in the datasheet.

Application Notes

Packaging Information

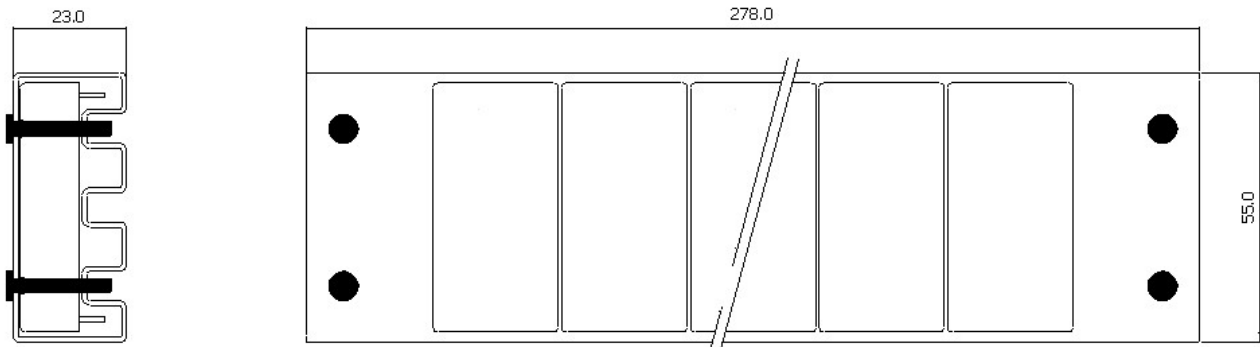

Wave Soldering Considerations

Lead free wave solder profile

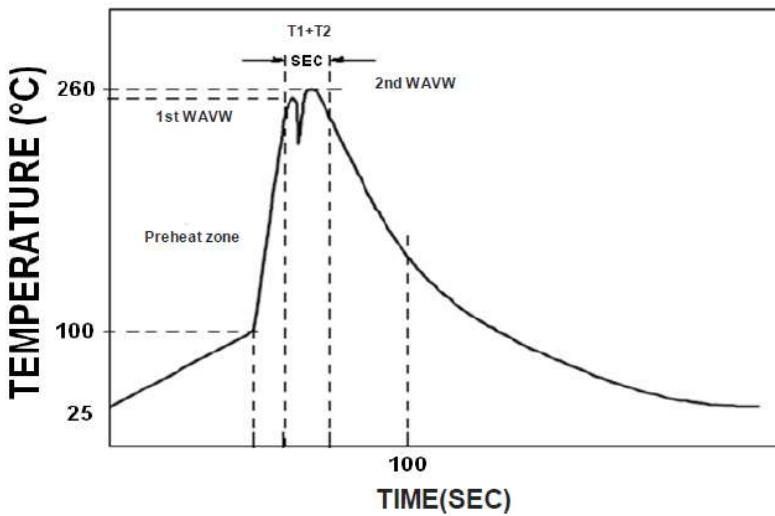

Zone	Reference Parameter
Heating rate during preheat	Rise temp speed: 3°C/sec max.
Final preheat temperature	Preheat temp: 100~130°C
Peak temperature	Peak temp: 250~260°C Peak Time
Time within peak temperature	Peak time(T1+T2): 4~6 sec

Reference Solder: Sn-Ag-Cu: Sn-Cu: Sn-Ag
 Hand Welding: Soldering iron: Power 60W
 Welding Time: 2~4 sec
 Temp.: 380~400 °C

Record of Revision and Changes

Issue	Date	Description	Originators
1.0	01.11.2017	First Issue	K. Wang
1.1	09.25.2017	Update the ESD voltage rating; Add the 4th edition EMI EN55011 and EMS EN60601-1-2; Update input current, ripple, operating temperature, pin diameter and derating curves	A. Zhang



For international contact information,
visit advancedenergy.com.

powersales@aei.com (Sales Support)
productsupport.ep@aei.com (Technical Support)
+1 888 412 7832

ABOUT ADVANCED ENERGY

Advanced Energy (AE) has devoted more than three decades to perfecting power for its global customers. AE designs and manufactures highly engineered, precision power conversion, measurement and control solutions for mission-critical applications and processes.

Our products enable customer innovation in complex applications for a wide range of industries including semiconductor equipment, industrial, manufacturing, telecommunications, data center computing, and medical. With deep applications know-how and responsive service and support across the globe, we build collaborative partnerships to meet rapid technological developments, propel growth for our customers, and innovate the future of power.

PRECISION | POWER | PERFORMANCE

Specifications are subject to change without notice. Not responsible for errors or omissions. ©2020 Advanced Energy Industries, Inc. All rights reserved. Advanced Energy®, and AE® are U.S. trademarks of Advanced Energy Industries, Inc.