

**Extremely fast, digital, programmable PID controller
for using in combination with a digital IMPAC pyrometer**

PI 6000

Programmable PID controller



- Extremely fast with 250 μ s sampling time
- Easy programming via PC
- 9 single controlling programs storable
- Handling independent of a PC
- For use with a digital IMPAC pyrometer as transducer
- Automatic detection of the connected pyrometer
- Automatic PI self tuning
- Additional connector for an alarm pyrometer
- Automatic on-off operation for generators with limitations on the minimum level



The **PI 6000** is a fast, autonomously operating PID programmable controller for usage in connection with an IMPAC digital pyrometer.

The utilisation of a pyrometer as a transducer provides very fast actual value measurement. These values are processed extremely quickly in the PI 6000 with a sampling time of only 250 μ s. The device is therefore predominantly used in applications in which fast temperature measurement and control are required, e.g. in induction surface hardening.

Up to 9 control programs can be programmed in the PI 6000; these programs can be used to define de-

sired temperatures that can be applied one after the other with changes from one temperature to the next controlled, based on time or temperature. The AutoTune function automatically finds unknown control parameters for new tasks.

As a result even difficult control tasks can be solved.

The control programs are prepared easily using a PC and the *InfraWin* software supplied, then the PI 6000 operates autonomously without a PC.

The control programs saved can be selected, started, stopped or even briefly interrupted using the buttons

on the controller; inadvertent changes to the control data are not possible on the PI 6000.

In operation, the display provides information on the actual temperature measured by the pyrometer, the control program selected as well as the controller output's activity. LEDs over the buttons indicate the program status.

In addition the *InfraWin* software has features for analysing and monitoring the actual control process; a useful instrument for the optimisation of the control parameters and placing in operation.

Technical Data

Measured data display:	4-digit 7-segment LED display, 13 mm, red Display of the measuring unit °C or °F, 7 mm, red
Program no. display:	Single digit 7-segment LED display, 13 mm, red
Controlled variable display:	10-section vertical LED bar display, approx. 4.5 mm wide, red
Sampling time:	250 µs
Proportional element Xp:	0.0 ... 1000.0%
Integration time Ki:	0 to 10 minutes in 10 ms steps
Differential time Kd:	0 to 10 minutes in 10 ms steps
Controlled variable limiting:	0.0 ... 100.0%
Duration of a program step (segment):	Up to 27 minutes in 1/10 s steps, up to 4.5 hours in 1 s steps, up to 45.5 hours in 10 s steps, "CONT" for continuous operation
Number of programs:	Maximum 9
Number of temperature steps (segments):	Maximum 20 per control program
AutoTune mode	For determining Xp and Ki (Kd = 0) for a control temperature
Power supply:	18 ... 30 V DC, ripple < 50 mV _{pp}
Power consumption:	Approx. 2.5 W (controller without external load)
Analog input 1: (measurement pyrometer)	0/4... 20 mA, input resistance approx. 120 Ω for transferring the measured values from the pyrometer to the PI 6000
Analogue input 2: (optional alarm pyrometer)	0/4 ... 20 mA, input resistance approx. 120 Ω, for connection of an additional pyrometer for shut-down in case of overtemperature (safety shut-down)
Analogue output: (electrically isolated from the power supply)	0/4 ... 20 mA output, load max. 500 Ω, continuous controlled variable 0 ... 100%
Digital interface to the pyrometer:	Can be changed between RS232 or RS485 half duplex, for communication with the measurement pyrometer. The transmission speed is automatically adjusted to the same speed as is set on the PC interface.
Digital interface to the PC: (electrically isolated from the power supply)	RS232, transmission speed 9600... 38400 Bd for connection to a PC or a higher level controller (PLC)
Control input:	Contact (normally open) for starting and stopping the selected control program, power supply positive or negative can be used as the reference
Control outputs:	4 semiconductor relays, maximum load 50 V DC or 36 V AC 0.2 A - Signal when a control program is running - Signal when the generator is to provide power - Signal when the alarm pyrometer (option) has triggered a safety shut-down - Pulse of selectable length when the control program has been completed
Operating temperature:	0 ... 50°C at the housing
Storage temperature:	-20 ... 70°C
Weight:	Approx. 250 g
Ingress protection:	Front IP40, terminals IP20 (in accordance with DIN 40 050)
Protection class:	Protection class III (in accordance with EN61140)
Display resolution:	1°C or 1°F
Housing:	Plastic housing (flame-retardant Noryl), 48 x 96 x 141 mm (H x W x D) in accordance with DIN 43 700 with screw clips for front panel mounting
Front panel cut-out:	45 ^{+0.6} x 92 ^{+0.8} mm
Installation depth required:	≥ 165 mm with terminals and cables
Connections:	Plug-in terminals, wire cross-section 0.14 ... 2.5 mm ² (AWG 26 ... 14), with ferrules: 0.5 ... 1.5 mm ²

Typical layout / technical explanations

The PI 6000 is specially designed for fast control processes, e.g., during induction surface hardening. Conventional PID controllers are generally not suitable for such processes due to their slow processing time, even if they operate with a pyrometer as a transducer.

The IMPAC pyrometer is connected to the PI 6000 using both analog and digital interfaces. The analog output ensures the fast transfer of the measured values, the digital connection is used for the communication with the pyrometer. As a result the PI 6000 knows, e.g., the pyrometer measuring range or can adjust the emissivity setting in the pyrometer for each control program.

The individual control programs are set with the aid of a PC and the InfraWin software supplied. In addition, the control process can be displayed and, if necessary, optimised with the aid of the PC during testing and placing in operation.

It is also possible to connect an alarm pyrometer to the PI 6000 for triggering an overtemperature alarm.

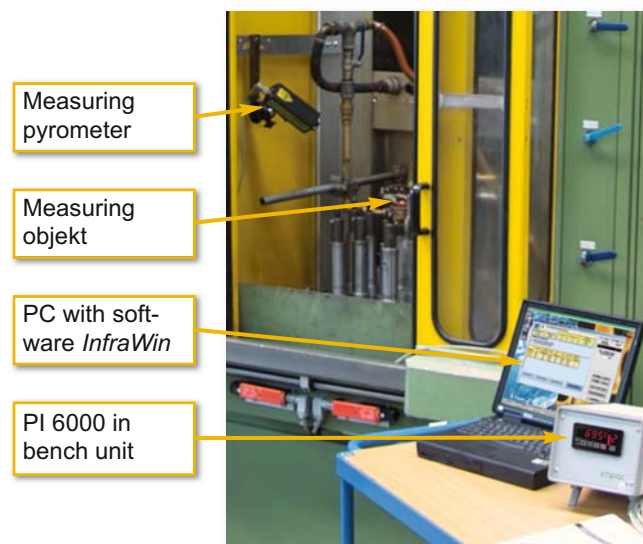

Display / Controls

The controls on the front of the unit are designed for the operation of a pre-programmed PID control system, the display provides information on the actual temperature measured by the pyrometer, the selected control program as well as the controller activity. LEDs over the buttons indicate the program status.

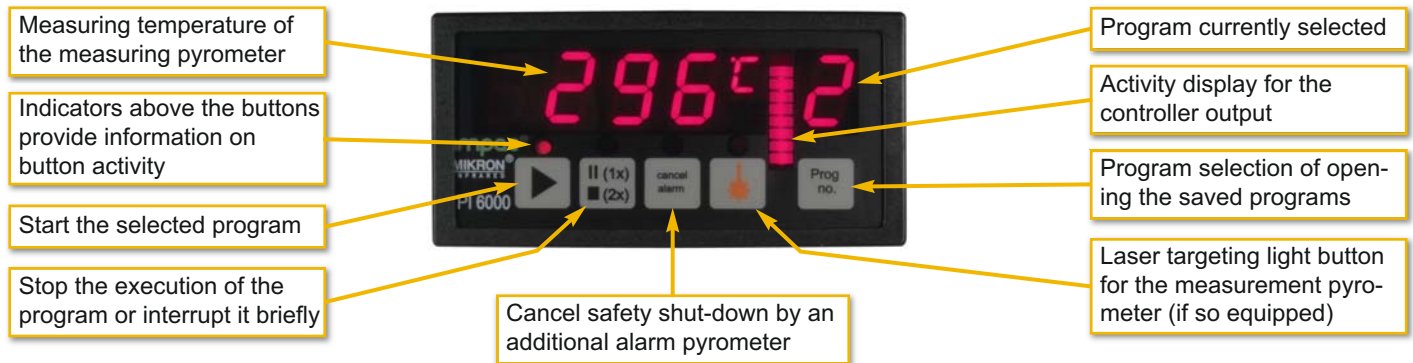

Software environment

The control programs are prepared and the basic configuration of the controller and the measurement pyrometer connected is defined using the easy to use *InfraWin* software (the disclosed data protocol also makes custom programming possible).

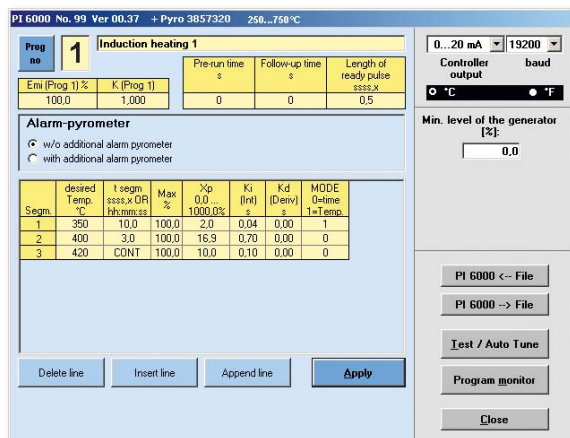

Programming window: The programming window is the central feature for the preparation of the control programs. This window is used to define to the PI 6000 which type of control is to be used at a specific time or on reaching a specific temperature.

The segments to be processed are defined straightforwardly in rows in a table in which all the values to be processed are written. The segments are then worked through in order when a control program is started.

The PI 6000 can store 9 control programs with up to 20 segments each, long-term control systems are also possible with the continuous mode. All control data sets determined can be saved in a file on the PC and can be loaded back into the PI 6000 later.

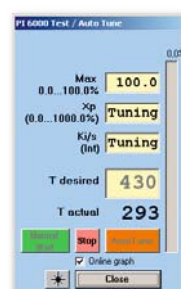
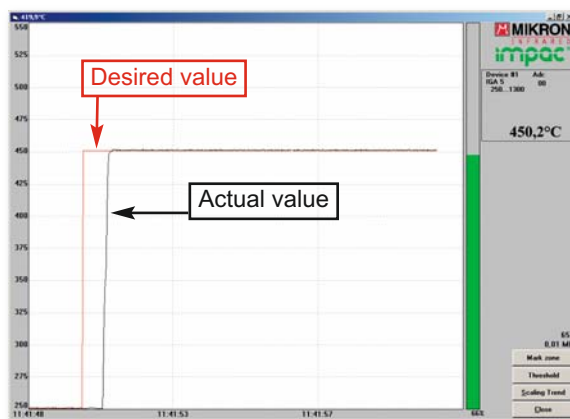

Test / AutoTune:

Using the "Test / Auto Tune" window, close approximate values for the proportional element and the integral element can be determined. The differential element is set = 0 during this process.

To check this automatic setting, the desired and actual temperature curves can be displayed, and fine adjustments made for an optimal control result, as necessary.

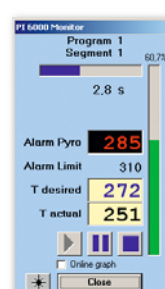
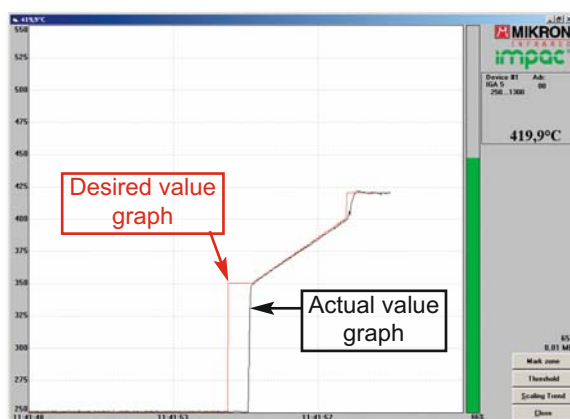

The monitor window:

Using the program monitor window a completed control program can be tested before it is started using the buttons on the PI 6000. Each individual program step (each segment) is worked through in order. The progress of the program can be followed visually and checked using the "online graph" function.

If an alarm pyrometer is connected to the PI 6000, the actual temperature measured by this pyrometer can be read in the program monitor window.

Dimensions / Connectors

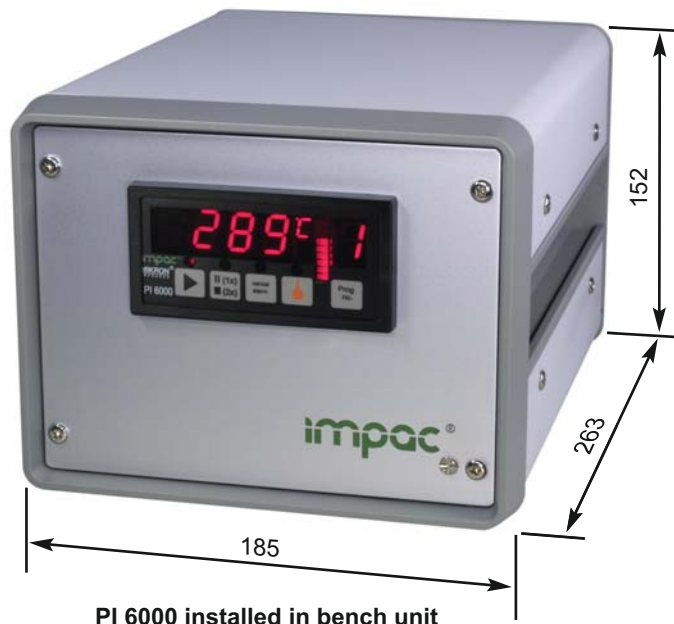

Pin assignment:

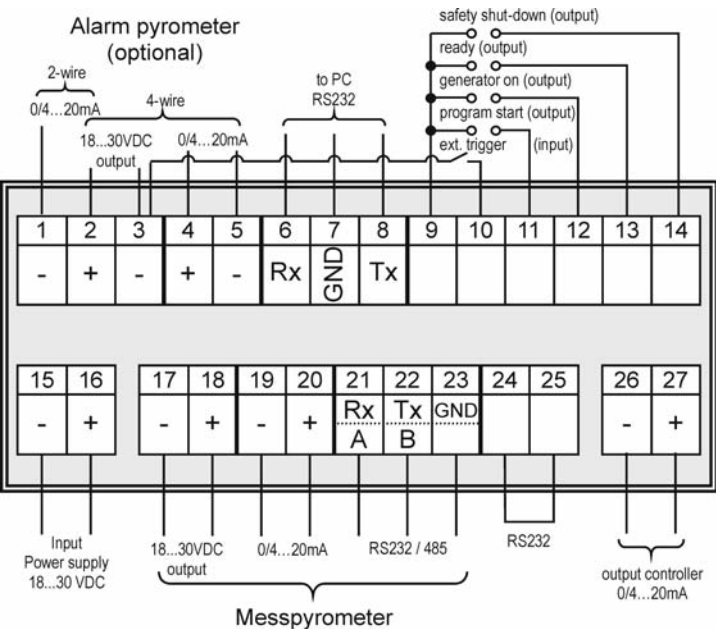

Note: Any pyrometer suitable for the measured object and that has an analogue output 0 ... 20 mA or 4 ... 20 mA and positive measuring range limits can be used as the alarm pyrometer.

Reference Numbers

Instrument:
 3 826 510 PI 6000 for front panel fixing
 3 828 210 Bench unit TG 6-PI (for installing the PI 6000) incl. power supply and 5 m pyrometer cable)

Scopr of delivery:
 Instrument, operating and analyzing software *InfraWin*, user manual



For international contact information, visit advancedenergy.com.
 sales.support@aei.com
 +1 970 221 0108

PRECISION | POWER | PERFORMANCE

Specifications are subject to change without notice. Not responsible for errors or omissions. ©2019 Advanced Energy Industries, Inc. All rights reserved. Advanced Energy® and AE® are U.S. trademarks of Advanced Energy Industries, Inc.

Specifications are subject to change without notice